





# REPAIR HINTS

[bg]	Съвети за ремонт .....	2
[hr]	Savjeti za popravak .....	26
[cs]	Poznámky k opravě .....	50
[da]	Tip til reparation .....	74
[nl]	Reparatie informatie .....	98
[en]	Repair hints .....	122
[et]	Remonditeave .....	146
[fi]	Korjausvinkit .....	170
[fr]	Conseils de réparation .....	194
[de]	Reparatur Hinweise .....	218
[el]	Υποδείξεις επισκευής .....	242
[hu]	Javítási útmutató .....	266
[it]	Consigli di riparazione .....	290
[lv]	Informācija par remontu .....	314
[lt]	Informacija apie remontą .....	338
[no]	Reparasjonstips .....	362
[pl]	Wskazówki naprawy .....	386
[pt]	Dicas de resolução .....	410
[ro]	Indicii pentru reparații .....	434
[sk]	Poznámky k opravám .....	458
[sl]	Nasveti za popravilo .....	482
[es]	Consejos de reparación .....	506
[sv]	Reparationsinformation .....	530
[tr]	Onarım İpuçları .....	554

# Съвети за ремонт - Fridge-freezer

 <b>Относно този документ</b> .....	<b>3</b>	4.8 Смяна на контейнера за замразени хранителни продукти .....	19
1.1 Важна информация.....	3	4.8.1 Изваждане на контейнера за замразени хранителни продукти.....	19
1.1.1 Цел.....	3	4.8.2 Монтиране на контейнера за замразени хранителни продукти.....	19
1.2 Обяснение на символите .....	3	4.9 Смяна на контейнера за плодове и зеленчуци .....	20
1.2.1 Нива на опасност .....	3	4.9.1 Изваждане на контейнера за плодове и зеленчуци .....	20
1.2.2 Символи за опасност.....	3	4.9.2 Монтиране на контейнера за плодове и зеленчуци .....	20
1.2.3 Структура на предупрежденията .....	4	4.10 Смяна на преградната плоча и капака на контейнера за плодове и зеленчуци .....	21
1.2.4 Общи символи.....	4	4.10.1 Изваждане на преградната плоча и капака на контейнера за плодове и зеленчуци .....	21
 <b>Безопасност</b> .....	<b>5</b>	4.10.2 Монтиране на преградната плоча и капака на контейнера за плодове и зеленчуци .....	21
2.1 Общи инструкции за безопасност .....	5	4.11 Смяна на контейнера за прясно охладени продукти .....	22
2.1.1 Всички домашни уреди.....	5	4.11.1 Изваждане на контейнера за прясно охладени продукти.....	22
 <b>Инструменти и помощни средства</b> .....	<b>6</b>	4.11.2 Монтиране на контейнера за прясно охладени продукти.....	22
 <b>Ремонт</b> .....	<b>7</b>	4.12 Смяна на разтегателния контейнер.....	23
4.1 Смяна на уплътнителя на вратата .....	7	4.12.1 Изваждане на разтегателния контейнер .....	23
4.1.1 Сваляне на уплътнителя на вратата .....	7	4.12.2 Монтиране на разтегателния контейнер .....	23
4.1.2 Монтиране на уплътнителя на вратата .....	7	4.13 Смяна на LED спот лампата .....	24
4.2 Смяна на плоска панта .....	10	4.13.1 Сваляне на LED спот лампата .....	24
4.2.1 Сваляне на плоската панта .....	10	4.13.2 Монтиране на LED спот лампата .....	25
4.2.2 Монтиране на плоска панта.....	12		
4.3 Смяна на плъзгащата се панта .....	13		
4.3.1 Сваляне на плъзгащата се панта .....	13		
4.3.2 Монтиране на плъзгащата се панта .....	14		
4.4 Смяна на стелажа на вратата .....	15		
4.4.1 Изваждане на стелажа на вратата .....	15		
4.4.2 Монтиране на стелажа на вратата .....	15		
4.5 Смяна на рафта .....	16		
4.5.1 Изваждане на рафта .....	16		
4.5.2 Монтиране на рафта .....	16		
4.6 Смяна на разтегателния рафт .....	17		
4.6.1 Изваждане на разтегателния рафт .....	17		
4.6.2 Монтиране на разтегателния рафт.....	17		
4.7 Смяна на рафта на фризерното отделение.....	18		
4.7.1 Изваждане на рафта на фризерното отделение .....	18		
4.7.2 Монтиране на рафта на фризерното отделение .....	18		

# **i** Относно този документ

## 1.1 Важна информация

### 1.1.1 Цел

Тези съвети за ремонт помагат на потребителя да ремонтира сам уреди в съответствие с регламента за екологосъобразно проектиране на уредите (от 03.2021 г.).

Те съдържат информация как да сменят определени резервни части, включително предупреждения и рискове.

Ако имате някакви въпроси, моля свържете се с нашия отдел за обслужване на клиенти. Ние носим отговорност за щети, само ако съветите за ремонт са спазени правилно.

## 1.2 Обяснение на символите

### 1.2.1 Нива на опасност

Предупредителните нива се състоят от символ и сигнална дума. Сигналната дума показва сериозността на опасността.





Ниво на предупреждение	Значение
 <b>ОПАСНОСТ</b>	Неспазването на предупредителното съобщение ще доведе до смърт или сериозни наранявания.
 <b>ПРЕДУПРЕЖДЕНИЕ</b>	Неспазването на предупредителното съобщение може да доведе до смърт или сериозни наранявания.
 <b>ВНИМАТЕЛНО</b>	Неспазването на предупредителното съобщение може да доведе до леки наранявания.
<b>ВНИМАНИЕ!</b>	Неспазването на предупредителното съобщение може да доведе до имуществени щети.

Таблица 1: Нива на опасност

### 1.2.2 Символи за опасност

Символите за опасност са символични изображения, които дават индикация за вида опасност.

В този документ се използват следните символи за опасност:

Символ за опасност	Значение
	Общо предупредително съобщение
	Опасност от електрическо напрежение
	Риск от експлозия
	Опасност от порязвания

## **i** Относно този документ





Символ за опасност	Значение
	Опасност от премазване
	Опасност от горещи повърхности
	Опасност от силно магнитно поле
	Опасност от нейонизиращо лъчение

Таблица 2: Символи за опасност

### 1.2.3 Структура на предупрежденията

Предупрежденията в този документ имат стандартизиран външен вид и стандартизирана структура.

	<p><b>ОПАСНОСТ</b></p> <p><b>Вид и източник на опасността!</b> Възможни последици от игнориране на опасността/предупреждението.</p> <ul style="list-style-type: none"> <li>▶ Мерки и забрани за предотвратяване на опасността.</li> </ul>
--	---

Следният пример показва предупреждение, което уведомява за токов удар, предизвикан от части под напрежение. Споменава се мярката за избягване на опасността.

	<p><b>ОПАСНОСТ</b></p> <p><b>Риск от токов удар поради части под напрежение!</b> Смърт от токов удар</p> <ul style="list-style-type: none"> <li>▶ Изключете уредите от електрическото захранване поне 60 секунди преди започване на ремонта.</li> </ul>
--	---

### 1.2.4 Общи символи

В този документ се използват следните общи символи:







Общ символ	Значение
	Идентифициране на специален съвет (текст и/или графика)
	Идентифициране на прост съвет (само текст)
	Идентифициране на връзка към видео урок
	Идентифициране на необходимите инструменти
	Идентифициране на необходимите предварителни условия
	Идентифициране на условие (ако ..., тогава ...)
	Идентифициране на резултат
Старт	Идентифициране на ключ или бутон
[00123456]	Идентифициране на каталожен номер
Статус	Идентифициране на показания текст/прозорец (на дисплея на уреда)

Таблица 3: Общи символи

## **2.1 Общи инструкции за безопасност**

### **2.1.1 Всички домашни уреди**

#### **Риск от токов удар поради части под напрежение!**

- Грешки при ремонти, включващи електрически компоненти, могат да доведат до токов удар!
- Разкачете уреда от електрическата мрежа за поне 60 секунди, преди да започнете работа.
- След ремонта трябва да се извърши проверка за безопасност съгласно VDE 0701 или в съответствие със специфичните за страната разпоредби.

#### **Риск от нараняване от остри ръбове!**

- Носете предпазни ръкавици.

#### **Риск от премазване по време на ремонт, поддръжка, отстраняване на неизправности и сервиз поради тежки и движещи се компоненти**

- Носете защитни обувки.
- Закрепете тежките компоненти, така че да не паднат.
- Не позволявайте контакт на части от тялото с движещи се компоненти.

#### **Риск за безопасността/функцията на уреда!**

- Използвайте само оригинални резервни части.

#### **Риск от повреда на електростатично чувствителни компоненти (ESD)!**

- Не докосвайте модулите, включително връзки и проводникови пътища.

## Инструменти и помощни средства

посочване	Подробности	Изображения
Защитна кърпа [00342013]	60 см x 50 см	
Накрайник Torx TX20 [00340865]	6,3 мм (1/4")	
Специален инструмент [00342180]		

## 4.1 Смяна на уплътнителя на вратата

### Изискване:

- ✔ Вратата е отворена.

### 4.1.1 Сваляне на уплътнителя на вратата

1. Освободете уплътнителя на вратата от жлеба отляво и отдясно.

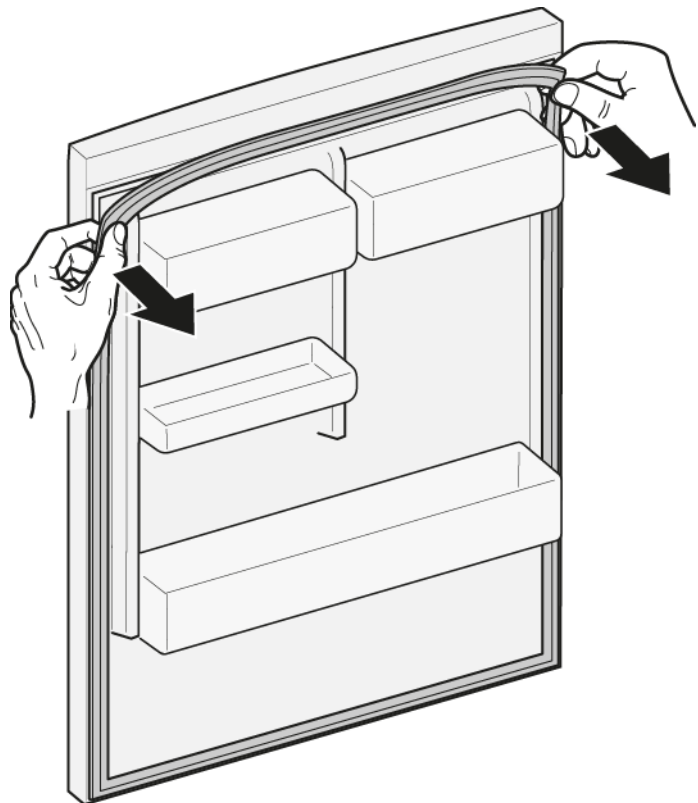

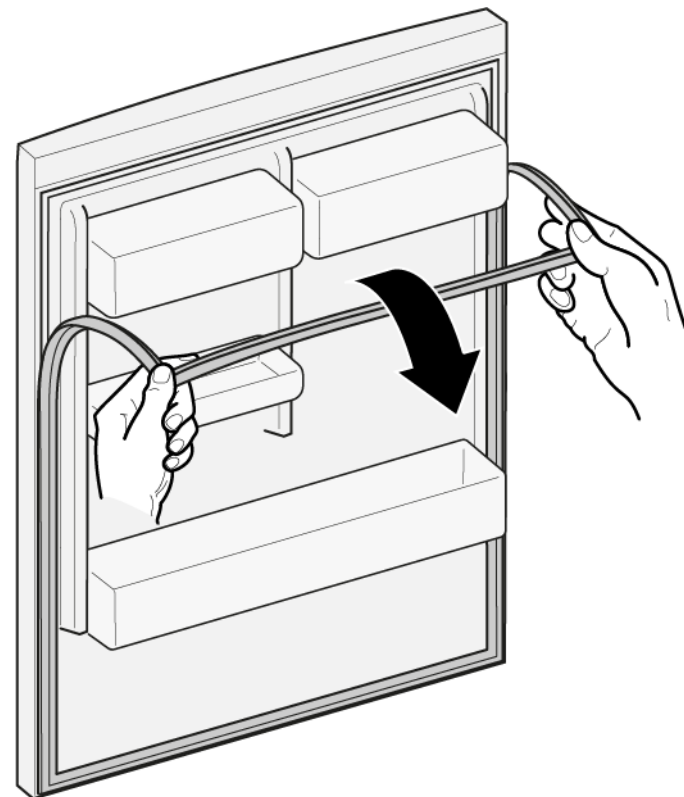

2. Извадете уплътнителя на вратата от жлеба.



- ➡ Уплътнителят на вратата е свален.

### 4.1.2 Монтиране на уплътнителя на вратата

	Дебелината на новия уплътнител на вратата може леко да се отличава от тази на стария уплътнител. Това няма да повлияе на начина на затваряне и нейната работа в дългосрочен план.
	Ако вашият уред има регулируеми панти или приставки за панти, можете да оптимизирате начина на затваряне по-късно.
	Малките странични отвори в уплътнителя на вратата са функционални (необходими за вентилация). Те не са производствени грешки.

1. Проверете жлеба на уплътнителя за повреди.

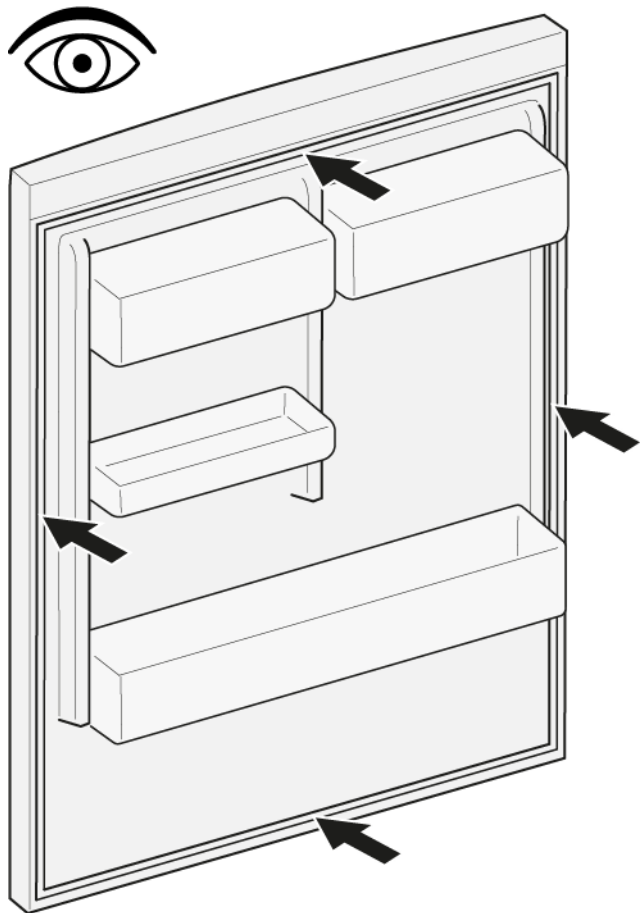

4. Натиснете ъглите на уплътнителя отгоре и отдолу към жлеба.

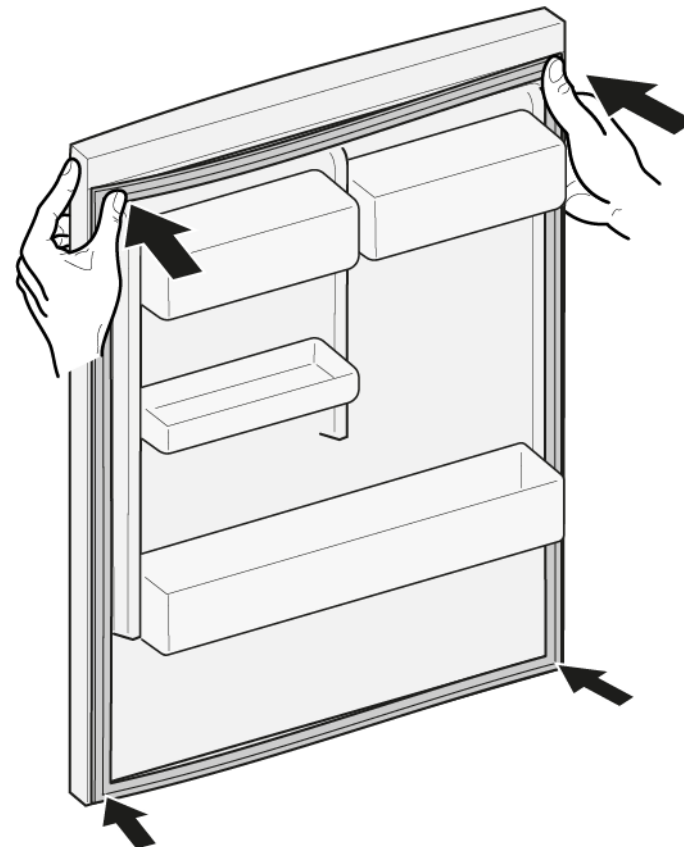

2.  Ако жлебът на уплътнителя е повреден:  
- Свържете се с отдела за обслужване на клиенти.

3.  Леката деформация на уплътнителя на вратата е нормална и не засяга неговата функция. Препоръчително е да изправите уплътнителя на вратата, преди да го поставите в уреда.

Загрейте уплътнителя на вратата със сешоар или гореща вода и променете формата му.



5. Постепенно вкарайте с натискане целия уплътнител в жлеба.

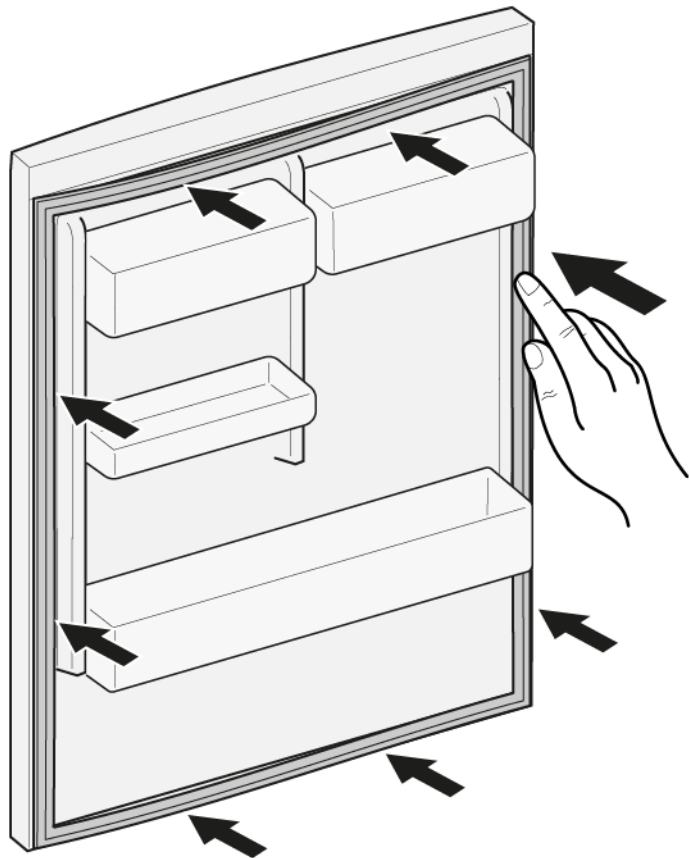



 Уплътнителят на вратата е монтиран.

## 4.2 Смяна на плоска панта

Специални инструменти:

 Накрайник Torx TX20      6,3 мм (1/4")      [00340865]

	<b>⚠ ПРЕДУПРЕЖДЕНИЕ</b>
	<p><b>Тежки, обемисти уреди!</b> Травми на гърба и мускулите</p> <ul style="list-style-type: none"> <li>▶ Операцията по отстраняване на вратите на уреда трябва да се извършва само от обучени специалисти.</li> <li>▶ За преместването на уреда са необходими двама души.</li> <li>▶ Използвайте само подходящи инструменти и оборудване.</li> </ul>



	<b>⚠ ВНИМАТЕЛНО</b>
	<p><b>Остри ръбове!</b> Наранявания от порязване</p> <ul style="list-style-type: none"> <li>▶ Носете предпазни ръкавици.</li> </ul>

	<b>⚠ ВНИМАТЕЛНО</b>
	<p><b>Отворете областта на пантите!</b> Премазване/захващане на пръстите</p> <ul style="list-style-type: none"> <li>▶ Не посягайте към областта на пантите.</li> <li>▶ Носете предпазни ръкавици.</li> </ul>

	<b>⚠ ВНИМАТЕЛНО</b>
	<p><b>Риск от падащи части поради разхлабени винтове!</b> Нараняване поради падащи части.</p> <ul style="list-style-type: none"> <li>▶ Закрепете компонента, така че да не падне.</li> </ul>

	<b>ВНИМАНИЕ!</b>
	<p><b>Риск от падащи части поради разхлабени винтове!</b> Повреда на други части на уреда или в дома на клиента, напр. дъното.</p> <ul style="list-style-type: none"> <li>▶ Закрепете компонента, така че да не падне.</li> </ul>

Изискване:

-  Уредът е изключен от захранването.
-  Мебелната врата е свалена. Вижте "Инструкция за монтаж".
-  Вратата е отворена.

### 4.2.1 Сваляне на плоската панта



1. Свалете четирите капачки на пантите.

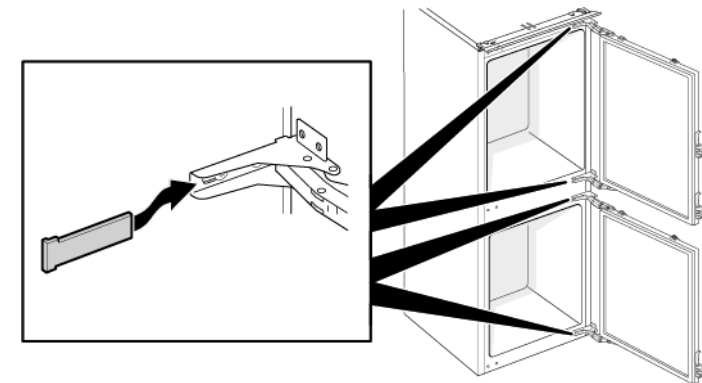

2. 1. Разхлабете четирите винта (1).  
2. Плъзнете навън и свалете горната врата (2).

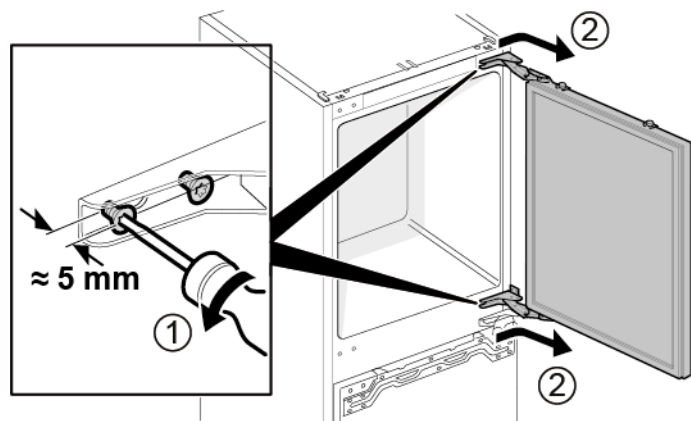

3. 1. Свалете четирите винта (1).  
2. Свалете пантите (2).

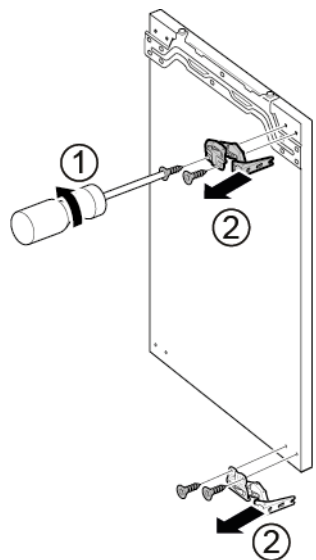

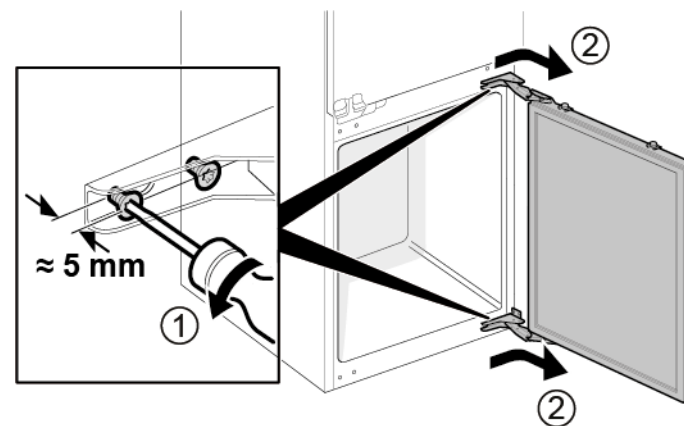

 Пантите на горната врата са свалени.

4. 1. Разхлабете четирите винта (1).  
2. Плъзнете навън и свалете долната врата (2).

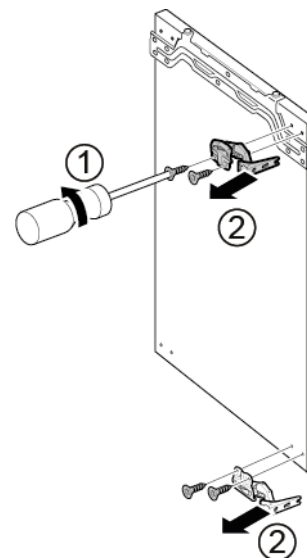

5. 1. Свалете четирите винта (1).  
2. Свалете пантите (2).



 Пантите на долната врата са свалени.

#### 4.2.2 Монтиране на плоска панта

- ▶ Монтирайте в обратен ред.

### 4.3 Смяна на плъзгащата се панта

#### Специални инструменти:

 Накрайник Torx TX20      6,3 мм (1/4")      [00340865]



	<b>⚠ ПРЕДУПРЕЖДЕНИЕ</b>
	<p><b>Тежки, обемисти уреди!</b> Травми на гърба и мускулите</p> <ul style="list-style-type: none"> <li>▶ Операцията по отстраняване на вратите на уреда трябва да се извършва само от обучени специалисти.</li> <li>▶ За преместването на уреда са необходими двама души.</li> <li>▶ Използвайте само подходящи инструменти и оборудване.</li> </ul>

	<b>⚠ ВНИМАТЕЛНО</b>
	<p><b>Остри ръбове!</b> Наранявания от порязване</p> <ul style="list-style-type: none"> <li>▶ Носете предпазни ръкавици.</li> </ul>

	<b>⚠ ВНИМАТЕЛНО</b>
	<p><b>Риск от падащи части поради разхлабени винтове!</b> Нараняване поради падащи части.</p> <ul style="list-style-type: none"> <li>▶ Закрепете компонента, така че да не падне.</li> </ul>

	<b>ВНИМАНИЕ!</b>
	<p><b>Риск от падащи части поради разхлабени винтове!</b> Повреда на други части на уреда или в дома на клиента, напр. дъното.</p> <ul style="list-style-type: none"> <li>▶ Закрепете компонента, така че да не падне.</li> </ul>

#### Изискване:

-  Уредът е изключен от захранването.
-  Мебелната врата и вратата на уреда са разделени. Вижте "Инструкция за монтаж".

#### 4.3.1 Сваляне на плъзгащата се панта

1. 1. Развийте двата винта (1).
2. Свалете горната панта на горната врата (2).
3. Свалете горната врата (3).
4. Развийте двата винта (4).
5. Свалете горната панта на долната врата (5).
6. Свалете долната врата (6).

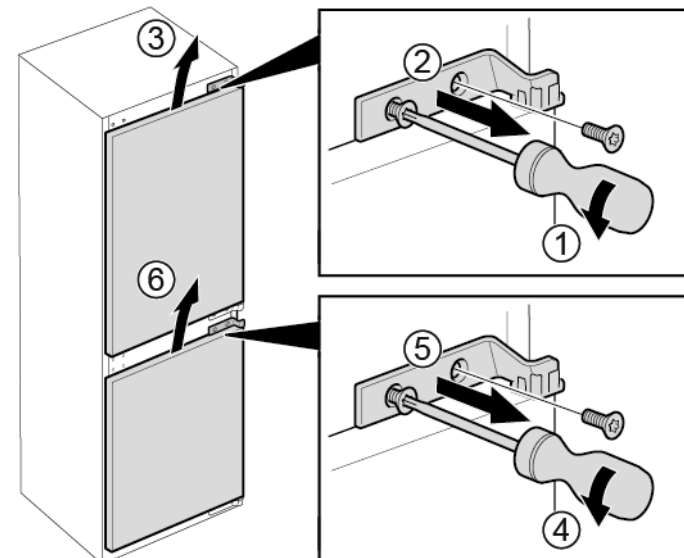

2. 1. Свалете четирите винта (1).
2. Свалете долните панти (2).

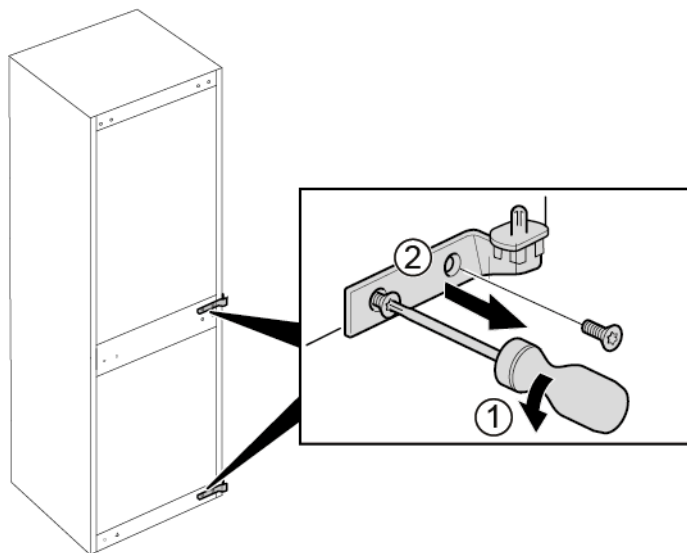

 Пантите са свалени.

#### 4.3.2 Монтиране на плъзгащата се панта

- ▶ Монтирайте в обратен ред.

## 4.4 Смяна на стелажа на вратата

### Изискване:

- ✔ Вратата е отворена.

### 4.4.1 Изваждане на стелажа на вратата

- ▶ Повдигнете стелажа на вратата нагоре.

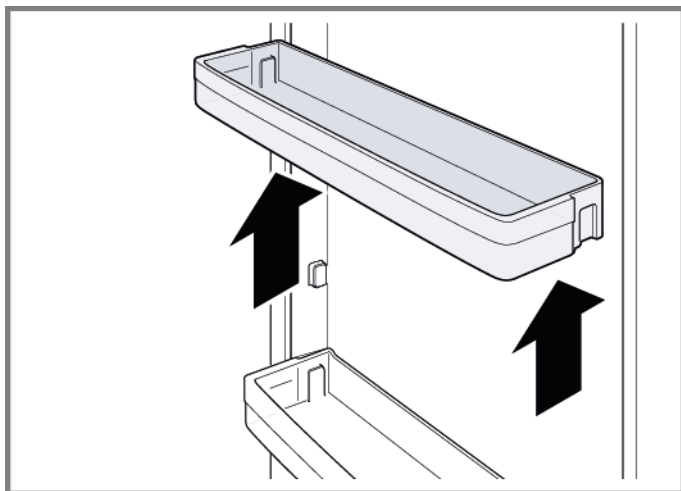

- ➡ Стелажът на вратата е свален.

### 4.4.2 Монтиране на стелажа на вратата

- ▶ Монтирайте в обратен ред.

## 4.5 Смяна на рафта

### Изискване:

- ✔ Вратата е отворена.

### 4.5.1 Изваждане на рафта

- ▶ Издърпайте рафта.

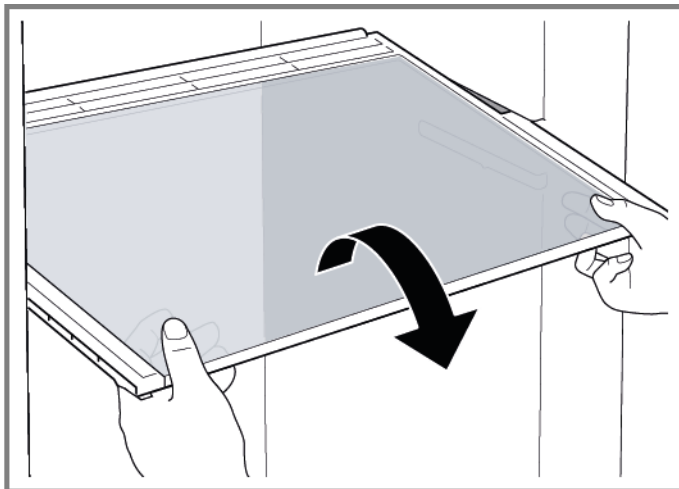

- ➡ Рафтът е свален.

### 4.5.2 Монтиране на рафта

- ▶ Монтирайте в обратен ред.



## 4.6 Смяна на разтегателния рафт

Изискване:

- ✔ Вратата е отворена.

### 4.6.1 Изваждане на разтегателния рафт

1. Издърпайте разтегателния рафт до освобождаване на фиксатора.

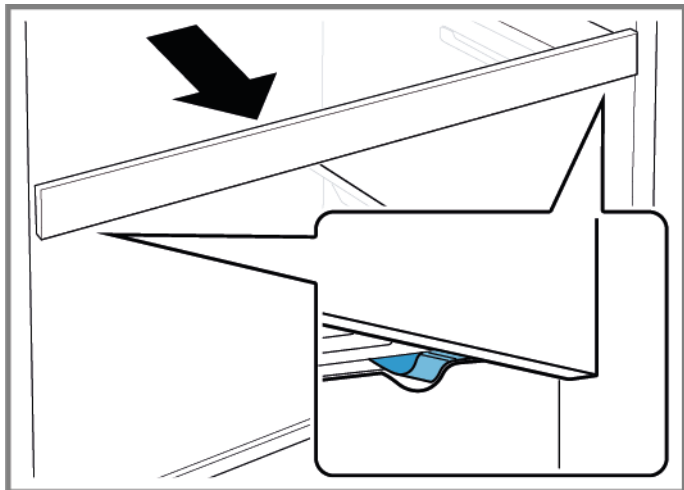

2. Спуснете разтегателния рафт и го завъртете настрани.
3. ➡ Разтегателният рафт е изваден.

### 4.6.2 Монтиране на разтегателния рафт

- ▶ Монтирайте в обратен ред.

## 4.7 Смяна на рафта на фризерното отделение

### Изискване:

- ✔ Вратата е отворена.

### 4.7.1 Изваждане на рафта на фризерното отделение

- ▶ Издърпайте рафта на фризерното отделение.

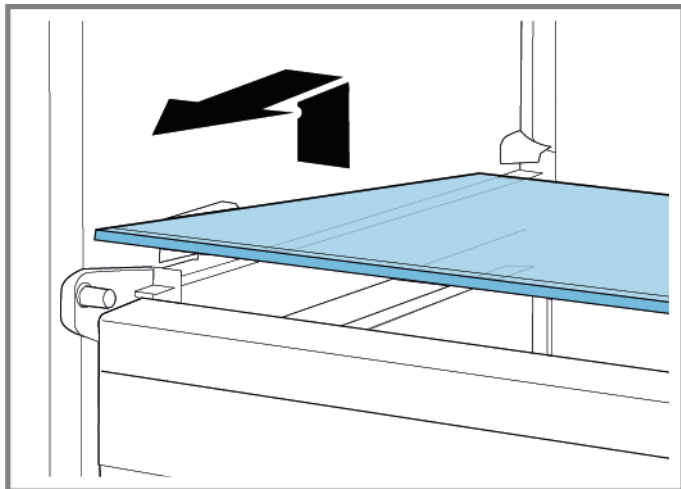

- ➡ Рафтът на фризерното отделение е изваден.

### 4.7.2 Монтиране на рафта на фризерното отделение

- ▶ Монтирайте в обратен ред.

## 4.8 Смяна на контейнера за замразени хранителни продукти

### Изискване:

- ✔ Вратата е отворена.

### 4.8.1 Изваждане на контейнера за замразени хранителни продукти

- ▶ 1. Издърпайте докрай контейнера за замразени хранителни продукти (1).
- ▶ 2. Извадете контейнера за замразени хранителни продукти (2).

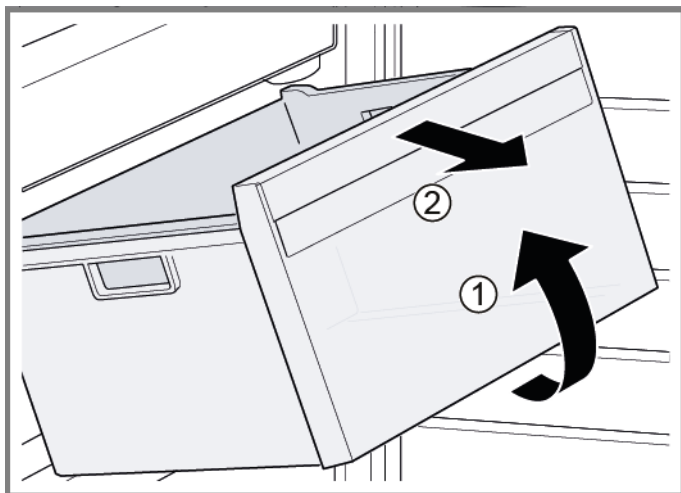

- ➡ Контейнерът за замразени хранителни продукти е изваден.

### 4.8.2 Монтиране на контейнера за замразени хранителни продукти

- ▶ Монтирайте в обратен ред.

## 4.9 Смяна на контейнера за плодове и зеленчуци

Изискване:

- ✔ Вратата е отворена.

### 4.9.1 Изваждане на контейнера за плодове и зеленчуци

- ▶ 1. Издърпайте напълно контейнера (1).
- ▶ 2. Извадете контейнера (2).

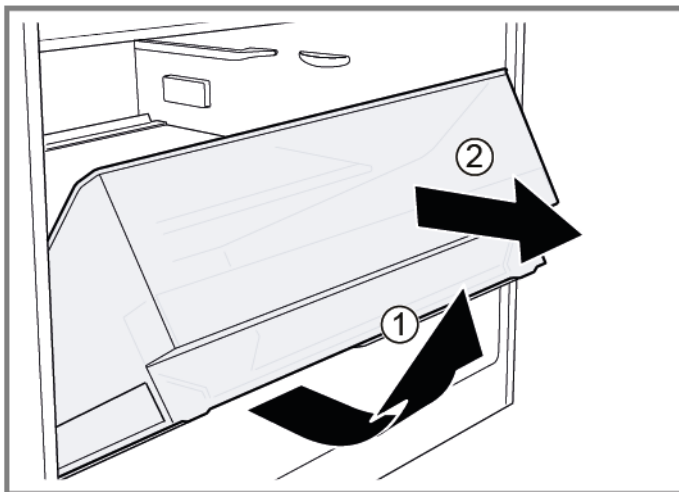

- ➡ Контейнерът е изваден.

### 4.9.2 Монтиране на контейнера за плодове и зеленчуци

- ▶ Монтирайте в обратен ред.

#### 4.10 Смяна на преградната плоча и капака на контейнера за плодове и зеленчуци

##### Изискване:

- ✔ Вратата е отворена.

##### 4.10.1 Изваждане на преградната плоча и капака на контейнера за плодове и зеленчуци

1. Свалете стъклената плоча от преградната плоча.

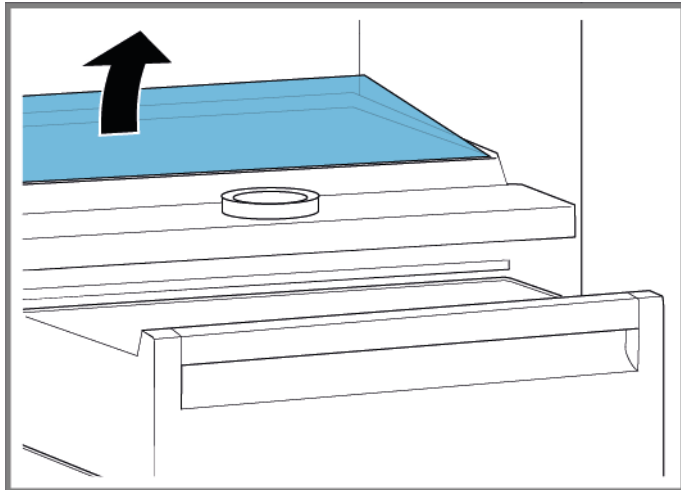

2. [Извадете контейнера за плодове и зеленчуци. → 20](#)

3. 1. Натиснете лоста отдолу върху двете страни на преградната плоча (1).  
2. Издърпайте преградната плоча напред (2).

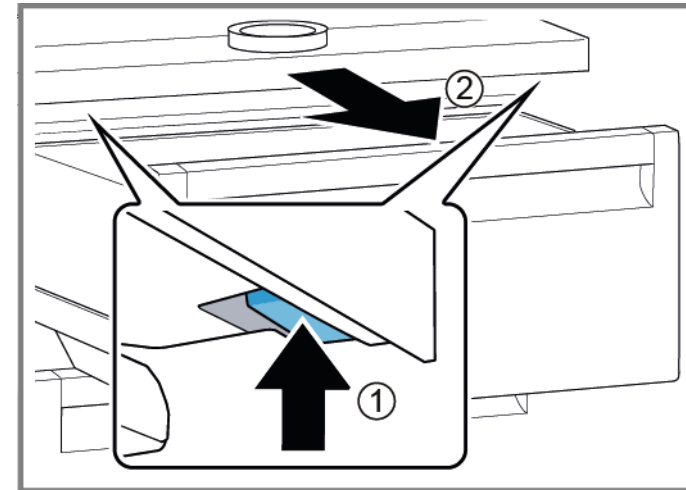

4. Вдигнете преградната плоча и я завъртете настрани.  
➡ Преградната плоча е извадена.
5. 1. Повдигнете капака на контейнера за плодове и зеленчуци.  
2. Издърпайте капака на контейнера за плодове и зеленчуци напред и го завъртете настрани.  
➡ Капакът на контейнера за плодове и зеленчуци е свален.

##### 4.10.2 Монтиране на преградната плоча и капака на контейнера за плодове и зеленчуци

- ▶ Монтирайте в обратен ред.

## 4.11 Смяна на контейнера за прясно охладени продукти

### Изискване:

- ✔ Вратата е отворена.

### 4.11.1 Изваждане на контейнера за прясно охладени продукти

- ▶ 1. Наклонете контейнера за прясно охладени продукти напред (1).
- ▶ 2. Извадете контейнера за прясно охладени продукти (2).

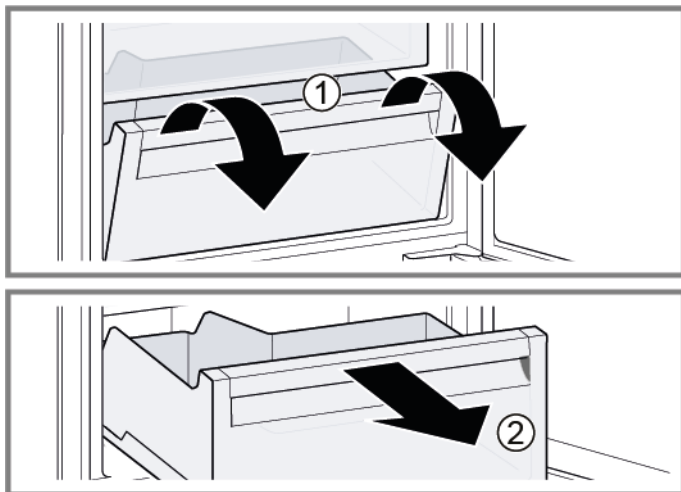

- ➡ Контейнерът за прясно охладени продукти е изваден.

### 4.11.2 Монтиране на контейнера за прясно охладени продукти

- ▶ Монтирайте в обратен ред.

## 4.12 Смяна на разтегателния контейнер

### Изискване:

- ✔ Вратата е отворена.

### 4.12.1 Изваждане на разтегателния контейнер

- ▶ 1. Наклонете разтегателния контейнер напред (1).
- ▶ 2. Извадете разтегателния контейнер (2).

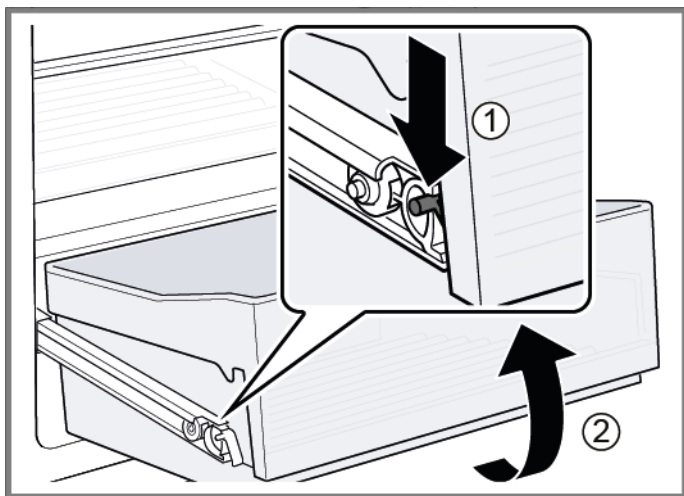



- ➡ Разтегателният контейнер е изваден.

### 4.12.2 Монтиране на разтегателния контейнер

- ▶ Монтирайте в обратен ред.



## 4.13 Смяна на LED спот лампата



### Специални инструменти:

-  Специален инструмент [00342180]
-  Плоска отвертка      Връх 2,4 мм x 0,4 мм x 60 мм, в комплекта [00341820]



	<p>Вашият уред е снабден с LED осветление, което не изисква поддръжка. Това осветление може да бъде ремонтирано само от специалисти от службата за обслужване на клиенти или от квалифицирани техници!</p>
---	--

	<p style="text-align: center;"> <b>ОПАСНОСТ</b></p> <p><b>Риск от токов удар поради части под напрежение!</b> Опасност за живота от токов удар в случай на неправилен ремонт</p> <ul style="list-style-type: none"> <li>▶ Електрическите части трябва да се ремонтират от квалифицирани електротехници.</li> <li>▶ След ремонта трябва да се извърши проверка за безопасност съгласно VDE 0701 или в съответствие със специфичните за страната разпоредби.</li> </ul>
--	--

	<p style="text-align: center;"> <b>ОПАСНОСТ</b></p> <p><b>Риск от токов удар поради части под напрежение!</b> Смърт от токов удар</p> <ul style="list-style-type: none"> <li>▶ Изключете уредите от електрическото захранване поне 60 секунди преди започване на ремонта.</li> </ul>
---	---

	<p style="text-align: center;"> <b>ВНИМАТЕЛНО</b></p> <p><b>Остри ръбове!</b> Наранявания от порязване</p> <ul style="list-style-type: none"> <li>▶ Носете предпазни ръкавици.</li> </ul>
--	--

### Изискване:

-  Уредът е изключен от захранването.
-  Вратата е отворена.
-  Рафтовете на хладилното отделение са извадени.

### 4.13.1 Сваляне на LED спот лампата

1. Освободете калъфа на LED спот лампата.

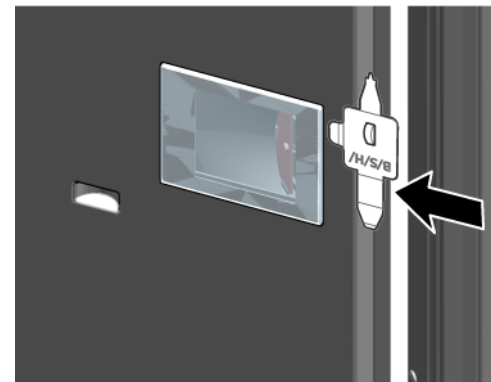

2. Издърпайте калъфа на LED спот лампата навътре и едновременно с натиснете напред.

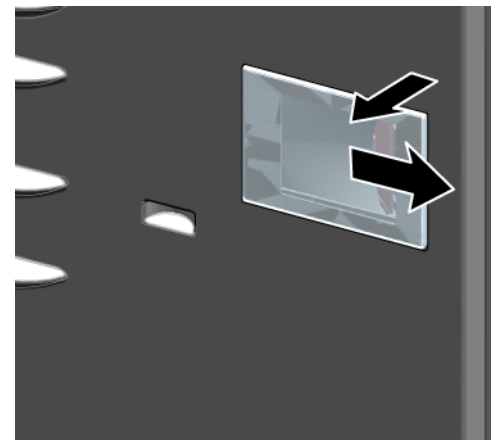



3. Отделете модула на LED спот лампата.

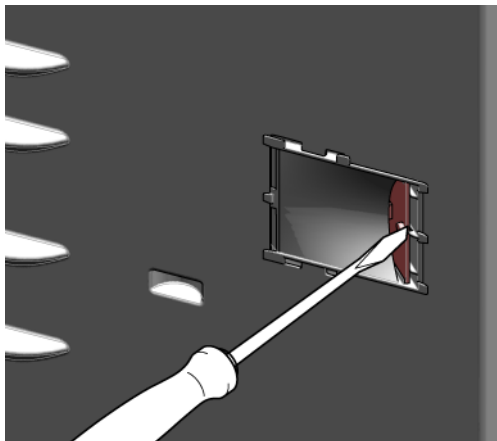

4. Изключете електрическата връзка на LED спот лампата.

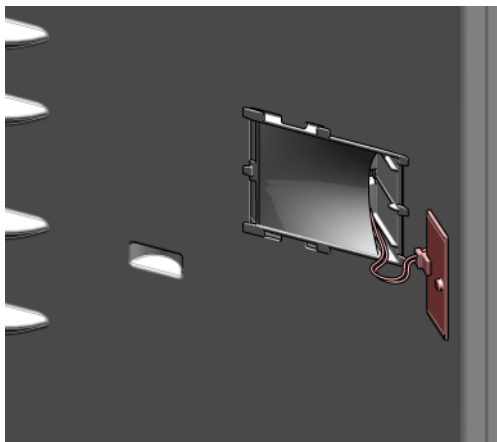





 LED спот лампата е свалена.

#### 4.13.2 Монтиране на LED спот лампата

▶ Монтирайте в обратен ред.

# Savjeti za popravak - Kombinacija hladnjak/zamrzivač

 <b>O ovom dokumentu</b> .....	<b>27</b>		
1.1 Važne informacije .....	27		
1.1.1 Svrha .....	27		
1.2 Objašnjenje oznaka .....	27		
1.2.1 Stupnjevi opasnosti .....	27		
1.2.2 Oznake opasnosti .....	27		
1.2.3 Struktura upozorenja .....	28		
1.2.4 Opće oznake .....	28		
 <b>Sigurnost</b> .....	<b>29</b>		
2.1 Opće sigurnosne upute .....	29		
2.1.1 Svi kućanski uređaji .....	29		
 <b>Alat i pomagala</b> .....	<b>30</b>		
 <b>Popravak</b> .....	<b>31</b>		
4.1 Zamjena brtve vrata .....	31		
4.1.1 Uklanjanje brtve vrata .....	31		
4.1.2 Postavljanje brtve vrata .....	31		
4.2 Zamjena ravnog zgloba .....	34		
4.2.1 Uklanjanje ravnog zgloba .....	34		
4.2.2 Postavljanje ravnog zgloba .....	36		
4.3 Zamjena kliznog zgloba .....	37		
4.3.1 Uklanjanje kliznog zgloba .....	37		
4.3.2 Postavljanje kliznog zgloba .....	38		
4.4 Zamjena posude za vrata .....	39		
4.4.1 Uklanjanje posude za vrata .....	39		
4.4.2 Postavljanje posude za vrata .....	39		
4.5 Zamjena police .....	40		
4.5.1 Uklanjanje police .....	40		
4.5.2 Postavljanje police .....	40		
4.6 Zamjena izvlačne police .....	41		
4.6.1 Uklanjanje izvlačne police .....	41		
4.6.2 Postavljanje izvlačne police .....	41		
4.7 Zamjena police odjeljka zamrzivača .....	42		
4.7.1 Uklanjanje police odjeljka zamrzivača .....	42		
4.7.2 Postavljanje police odjeljka zamrzivača .....	42		
4.8 Zamjena spremnika za zamrznute namirnice .....	43		
4.8.1 Uklanjanje spremnika za zamrznute namirnice .....	43		
4.8.2 Postavljanje spremnika za zamrznute namirnice .....	43		
4.9 Zamjena spremnika za voće i povrće .....	44		
4.9.1 Uklanjanje spremnika za voće i povrće .....	44		
4.9.2 Postavljanje spremnika za voće i povrće .....	44		
4.10 Zamjena pregrade i poklopca spremnika za voće i povrće .....	45		
4.10.1 Uklanjanje pregrade i poklopca spremnika za voće i povrće .....	45		
4.10.2 Postavljanje pregrade i poklopca spremnika za voće i povrće .....	45		
4.11 Zamjena spremnika za održavanje svježine .....	46		
4.11.1 Uklanjanje spremnika za održavanje svježine .....	46		
4.11.2 Postavljanje spremnika za održavanje svježine .....	46		
4.12 Zamjena izvlačnog spremnika .....	47		
4.12.1 Uklanjanje izvlačnog spremnika .....	47		
4.12.2 Postavljanje izvlačnog spremnika .....	47		
4.13 Zamjena LED usmjerenog svjetla .....	48		
4.13.1 Uklanjanje LED usmjerenog svjetla .....	48		
4.13.2 Postavljanje LED usmjerenog svjetla .....	49		

# **i** O ovom dokumentu

## 1.1 Važne informacije

### 1.1.1 Svrha

Ove upute za popravak služe kao podrška korisnicima prilikom samostalnog popravljivanja uređaja u skladu s primjenjivom Direktivom o ekološkom dizajnu (od ožujka 2021.).

One sadrže informacije o zamjeni određenih rezervnih dijelova, kao i napomene o upozorenjima i opasnostima.

Ako imate dodatna pitanja, obratite se našoj službi za korisnike. Mi snosimo odgovornost za oštećenja samo u slučaju pridržavanja uputa za popravak.

## 1.2 Objašnjenje oznaka

### 1.2.1 Stupnjevi opasnosti

Stupnjevi upozorenja sastoje se od oznake i signalne riječi. Signalna riječ ukazuje na ozbiljnost opasnosti.





Stupanj upozorenja	Značenje
 <b>OPASNOST</b>	Nepridržavanje poruke upozorenja rezultirat će smrtnim ili teškim ozljedama.
 <b>UPOZORENJE</b>	Nepridržavanje poruke upozorenja može rezultirati smrtnim ili teškim ozljedama.
 <b>OPREZ</b>	Nepridržavanje poruke upozorenja može rezultirati lakšim ozljedama.
 <b>POZORI!</b>	Nepridržavanje poruke upozorenja može rezultirati oštećenjem imovine.

Tablica 1: Stupnjevi opasnosti



### 1.2.2 Oznake opasnosti

Oznake opasnosti simbolička su reprezentacija s oznakom vrste opasnosti.

U ovom dokumentu koriste se sljedeće oznake opasnosti:

Oznaka opasnosti	Značenje
	Opća poruka upozorenja
	Opasnost od električnog napona
	Opasnost od eksplozije
	Opasnost od porezotina
	Opasnost od prignječenja

## O ovom dokumentu

Oznaka opasnosti	Značenje
	Opasnost od vrućih površina
	Opasnost od jakog magnetskog polja
	Opasnost od neionizirajućeg zračenja

Tablica 2: Oznake opasnosti

### 1.2.3 Struktura upozorenja

Upozorenja u ovom dokumentu imaju normirani izgled i strukturu.



	<div style="background-color: red; color: white; padding: 2px; text-align: center;"> <b>OPASNOST</b></div> <p><b>Vrsta i izvor opasnosti!</b> Moguće posljedice zanemarivanja opasnosti/upozorenja.</p> <ul style="list-style-type: none"> <li>▶ Mjere i zabrane za sprječavanje opasnosti.</li> </ul>
--	---





Sljedeći primjer pokazuje upozorenje na strujni udar od dijelova koji provode struju. Spominje se mjera za izbjegavanje opasnosti.

	<div style="background-color: red; color: white; padding: 2px; text-align: center;"> <b>OPASNOST</b></div> <p><b>Opasnost od strujnog udara zbog dijelova koji provode struju!</b> Smrt od strujnog udara</p> <ul style="list-style-type: none"> <li>▶ Isključite uređaj iz električnog napajanja najmanje 60 sekundi prije izvođenja popravaka.</li> </ul>
---	--

### 1.2.4 Opće oznake

U ovom dokumentu koriste se sljedeće opće oznake:

Opća znaka	Značenje
	Oznaka posebnog savjeta (tekst i/ili grafika)
	Oznaka jednostavnog savjeta (samo tekst)
	Oznaka veze na videovodič

Opća znaka	Značenje
	Oznaka potrebnog alata
	Oznaka potrebnih preduvjeta
	Oznaka uvjeta (ako ..., tad ...)
	Oznaka rezultata
[Početak]	Oznaka tipke ili gumba
[00123456]	Oznaka broja materijala
Status	Oznaka prikazanog teksta / prozor (na zaslonu uređaja)

Tablica 3: Opće oznake

## 2.1 Opće sigurnosne upute

### 2.1.1 Svi kućanski uređaji

#### **Opasnost od strujnog udara zbog dijelova koji provode struju!**

- Pogreške izazvane popravcima električnih sastavnih dijelova mogu dovesti do strujnog udara!
- Isključite uređaj iz struje na najmanje 60 sekundi prije početka radova.
- Nakon popravka provedite sigurnosni test u skladu s VDE 0701 ili nacionalnim propisima.

#### **Opasnost od ozljeda zbog oštih rubova!**

- Nosite zaštitne rukavice.

#### **Opasnost od prignječenja tijekom izvođenja radova na popravcima, održavanju, rješavanju problema i servisiranju teških i pokretnih sastavnih dijelova**

- Nosite zaštitnu obuću.
- Osigurajte teške sastavne dijelove od pada.
- Nemojte umetati dijelove tijela u pokretne sastavne dijelove.



#### **Opasnost za sigurnost/rad uređaja!**

- Koristite samo originalne rezervne dijelove.

#### **Opasnost od oštećenja elektrostatički osjetljivih sastavnih dijelova (ESD)!**

- Nemojte dodirivati module, uključujući priključke i rute vodiča.

## Alat i pomagala

Oznaka	Pojedinosti	Slike
Zaštitna navlaka [00342013]	60 cm x 50 cm	
Nastavak Torx TX20 [00340865]	6,3 mm (1/4")	
Specijalni alat [00342180]		

## 4.1 Zamjena brtve vrata

### Zahtjev:

-  Vrata su otvorena.

### 4.1.1 Uklanjanje brtve vrata

1. Otpustite brtvu vrata iz utora u desnom i lijevom kutu.

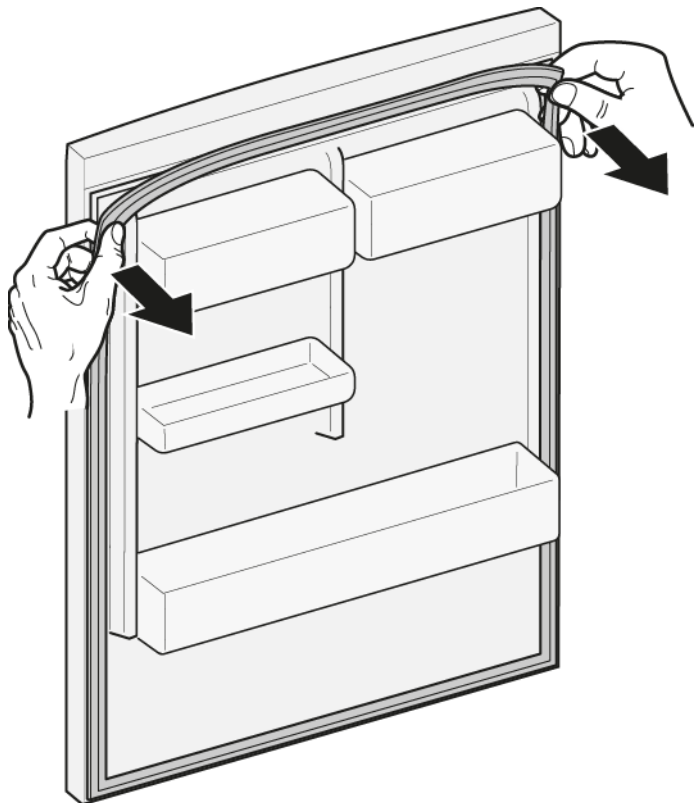

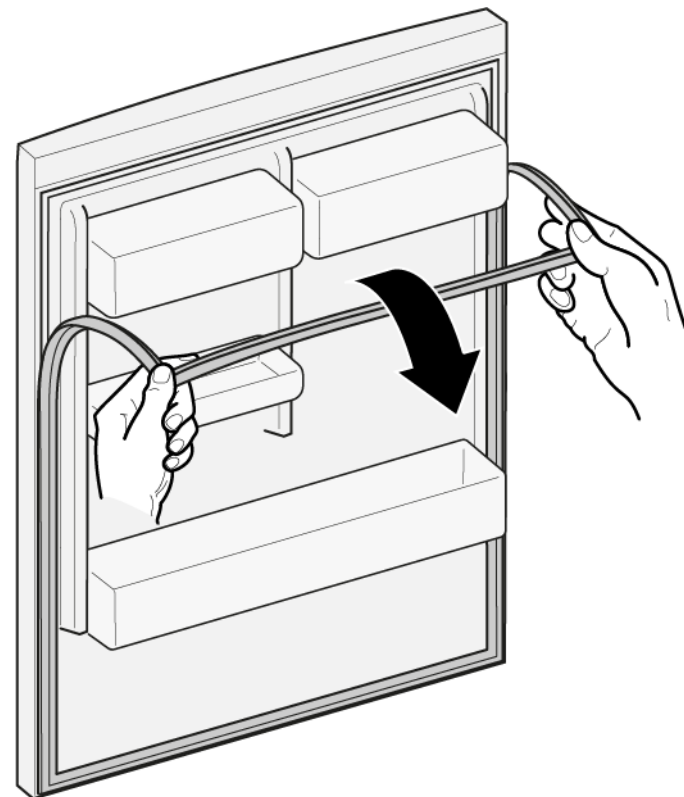

2. Izvucite brtvu vrata iz utora.



-  Brtva vrata je uklonjena.

### 4.1.2 Postavljanje brtve vrata

	Debljina nove brtve vrata može malo odstupati od debljine stare brtve vrata. To neće utjecati na zatvaranje i dugoročnu funkciju.
	Ako uređaj ima prilagodljive zglobove ili nastavke zglobova, možete dodatno optimizirati zatvaranje.
	Mali bočni otvori u brtvi vrata su funkcijski (potrebni za ventilaciju). Nije riječ o proizvodnim pogreškama.

1. Provjerite ima li oštećenja na utoru za brtvu.

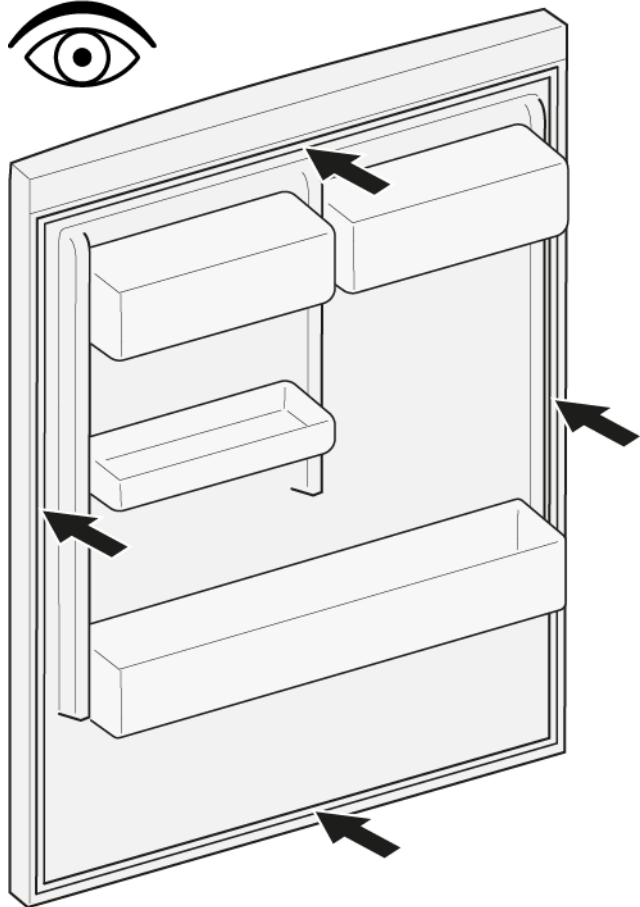

4. Gurnite kutove brtve na vrh i dno utora.

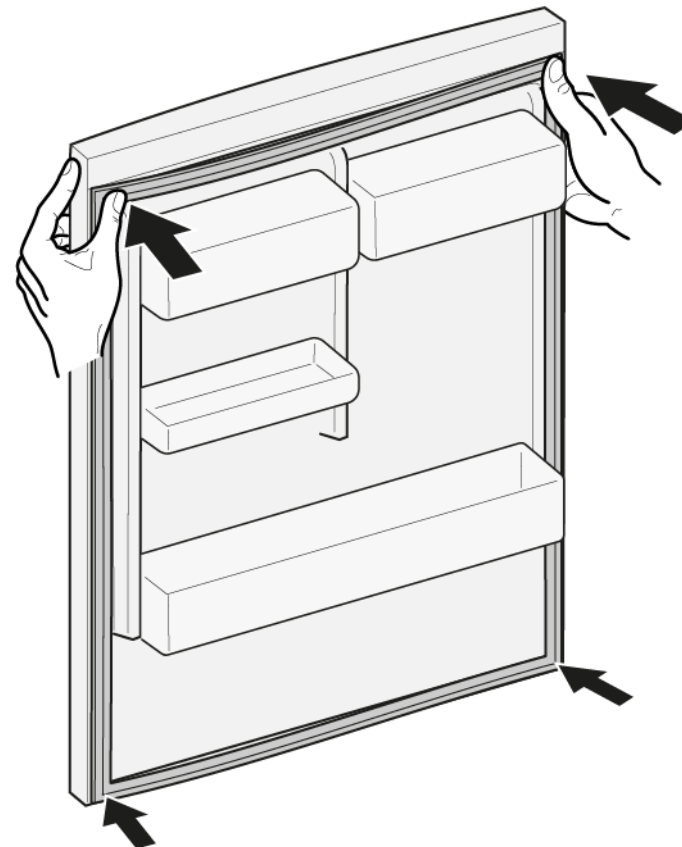

2.  Ako je utor za brtvu oštećen.  
- Obratite se službi za korisnike.

3.  Blago odstupanje brtve vrata normalno je i ne utječe na funkciju. Preporučuje se izravnati brtvu vrata prije umetanja u uređaj.

Zagrijte brtvu vrata sušilom za kosu ili vrućom vodom i ručno je oblikujte.



5. Utisnite cijelu brtvu korak po korak u utor.

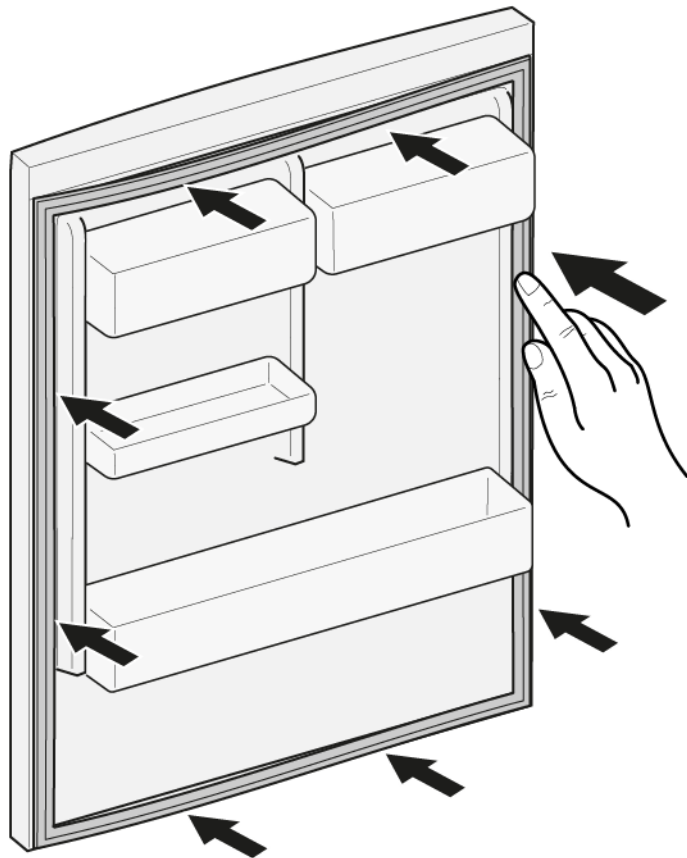

 Brtva vrata je postavljena.

## 4.2 Zamjena ravnog zgloba

### Specijalni alati:

🌀 Nastavak Torx TX20      6,3 mm (1/4")      [00340865]

	<b>⚠️ UPOZORENJE</b>
	<p><b>Teški, veliki uređaji!</b> Ozljede leđa i kralježnice</p> <ul style="list-style-type: none"> <li>▶ Uklanjanje vrata uređaja smiju obavljati samo obučeni stručnjaci.</li> <li>▶ Za pomicanje uređaja potrebne su dvije osobe.</li> <li>▶ Koristite samo prikladan alat i opremu.</li> </ul>

	<b>⚠️ OPREZ</b>
	<p><b>Oštri rubovi!</b> Porezotine</p> <ul style="list-style-type: none"> <li>▶ Nosite zaštitne rukavice.</li> </ul>

	<b>⚠️ OPREZ</b>
	<p><b>Otvorite područje zgloba!</b> Prignječenje/zaglavljivanje prstiju</p> <ul style="list-style-type: none"> <li>▶ Nemojte posezati rukama u područje zgloba.</li> <li>▶ Nosite zaštitne rukavice.</li> </ul>

	<b>⚠️ OPREZ</b>
	<p><b>Opasnost od padanja dijelova zbog otpuštenih vijaka!</b> Ozljeda od dijelova koji padaju.</p> <ul style="list-style-type: none"> <li>▶ Osigurajte sastavne dijelove od pada.</li> </ul>

	<b>POZOR!</b>
	<p><b>Opasnost od padanja dijelova zbog otpuštenih vijaka!</b> Oštećenje drugih dijelova uređaja ili objekta klijenta, npr. poda.</p> <ul style="list-style-type: none"> <li>▶ Osigurajte sastavne dijelove od pada.</li> </ul>

### Zahtjev:

- ✔️ Uređaj je isključen iz napajanja.
- ✔️ Vrata namještaja su uklonjena. Pogledajte upute za postavljanje.
- ✔️ Vrata su otvorena.

## 4.2.1 Uklanjanje ravnog zgloba



1. Uklonite četiri poklopca zgloba.

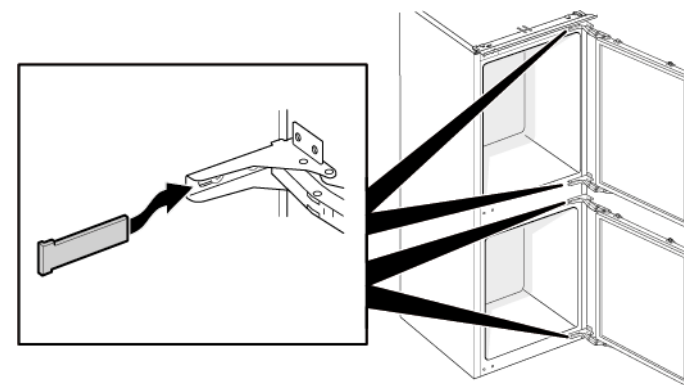

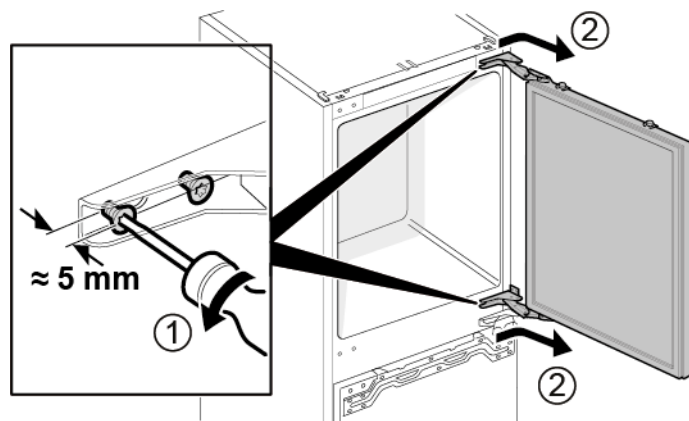

## Popravak

2. 1. Otpustite četiri vijka (1).  
2. Gurnite gornja vrata prema van i uklonite ih (2).

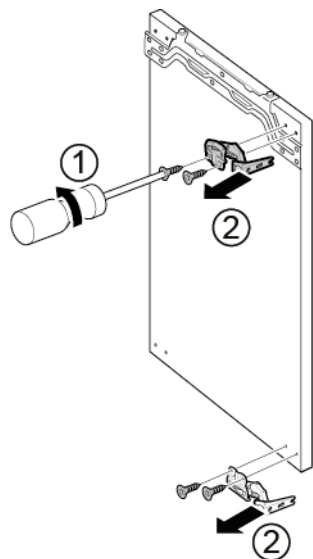

3. 1. Uklonite četiri vijka (1).  
2. Uklonite zglobove (2).



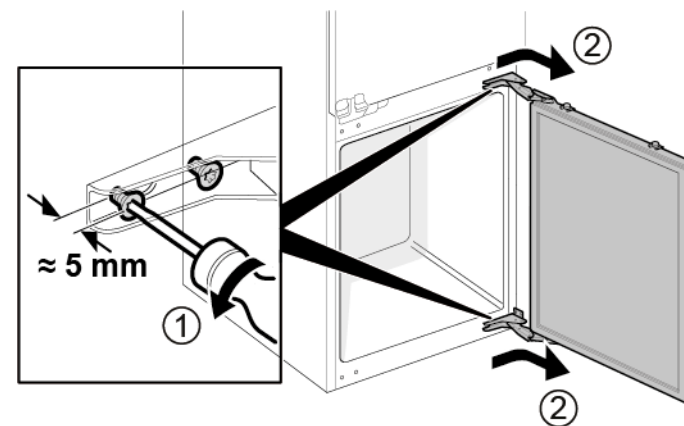

 Zglobovi gornjih vrata su uklonjeni.

4. 1. Otpustite četiri vijka (1).  
2. Gurnite donja vrata prema van i uklonite ih (2).

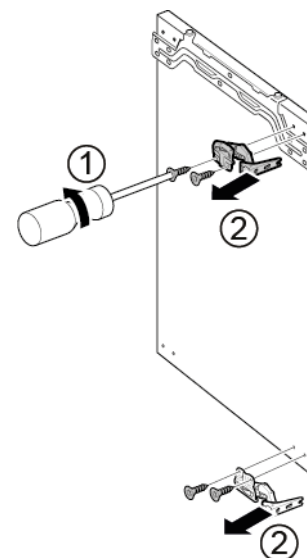

5. 1. Uklonite četiri vijka (1).  
2. Uklonite zglobove (2).



 Zglobovi donjih vrata su uklonjeni.

## 4.2.2 Postavljanje ravnog zgloba

- ▶ Postavite obratnim redoslijedom.

## 4.3 Zamjena kliznog zgloba

### Specijalni alati:

🌀 Nastavak Torx TX20      6,3 mm (1/4")      [00340865]

	<b>⚠ UPOZORENJE</b>
	<b>Teški, veliki uređaji!</b> Ozljede leđa i kralježnice ▶ Uklanjanje vrata uređaja smiju obavljati samo obučeni stručnjaci. ▶ Za pomicanje uređaja potrebne su dvije osobe. ▶ Koristite samo prikladan alat i opremu.

	<b>⚠ OPREZ</b>
	<b>Oštri rubovi!</b> Porezotine ▶ Nosite zaštitne rukavice.

	<b>⚠ OPREZ</b>
	<b>Opasnost od padanja dijelova zbog otpuštenih vijaka!</b> Ozljeda od dijelova koji padaju. ▶ Osigurajte sastavne dijelove od pada.

	<b>POZOR!</b>
	<b>Opasnost od padanja dijelova zbog otpuštenih vijaka!</b> Oštećenje drugih dijelova uređaja ili objekta klijenta, npr. poda. ▶ Osigurajte sastavne dijelove od pada.

### Zahtjev:

- ✔ Uređaj je isključen iz napajanja.
- ✔ Vrata namještaja i vrata uređaja su odvojena. Pogledajte upute za postavljanje.

## 4.3.1 Uklanjanje kliznog zgloba

1. 1. Odvijte dva vijka (1).
2. 2. Uklonite gornji zglob gornjih vrata (2).
3. 3. Uklonite gornja vrata (3).
4. 4. Odvijte dva vijka (4).
5. 5. Uklonite gornji zglob donjih vrata (5).
6. 6. Uklonite donja vrata (6).

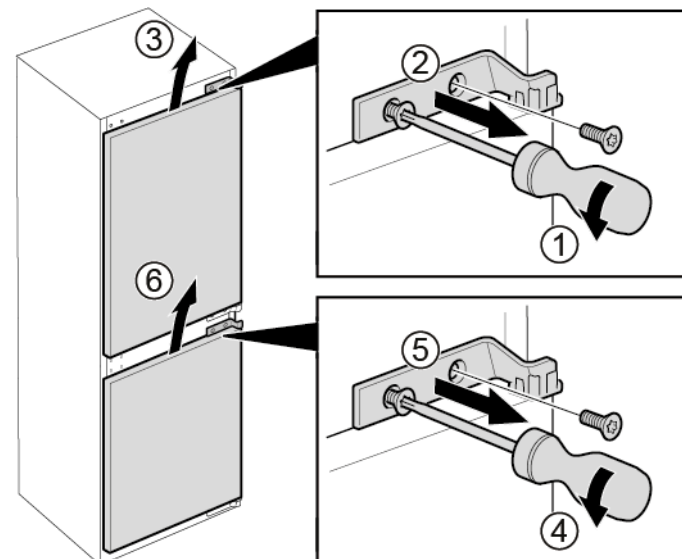

2. 1. Uklonite četiri vijka (1).
2. Uklonite donje zglobove (2).

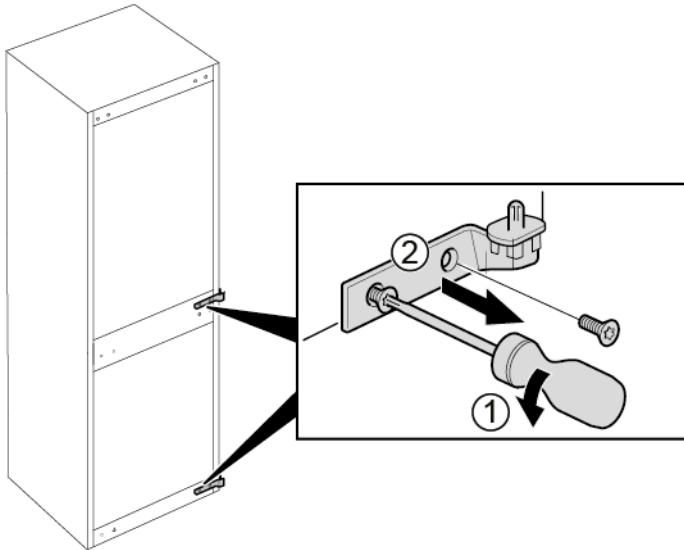

 Zglobovi su uklonjeni.

#### 4.3.2 Postavljanje kliznog zgloba

- ▶ Postavite obratnim redoslijedom.

## 4.4 Zamjena posude za vrata

### Zahtjev:

- ✔ Vrata su otvorena.

### 4.4.1 Uklanjanje posude za vrata

- ▶ Podignite posudu za vrata prema gore.

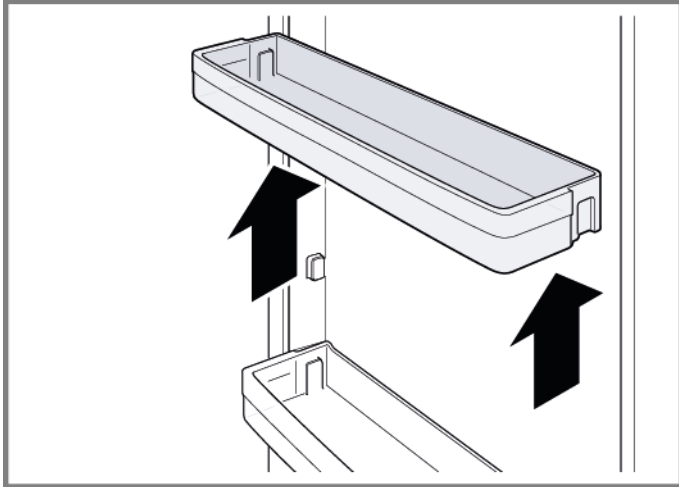

- ➡ Posuda za vrata je uklonjena.

### 4.4.2 Postavljanje posude za vrata

- ▶ Postavite obratnim redoslijedom.

## 4.5 Zamjena police

### Zahtjev:

- ✔ Vrata su otvorena.

### 4.5.1 Uklanjanje police

- ▶ Izvucite policu.

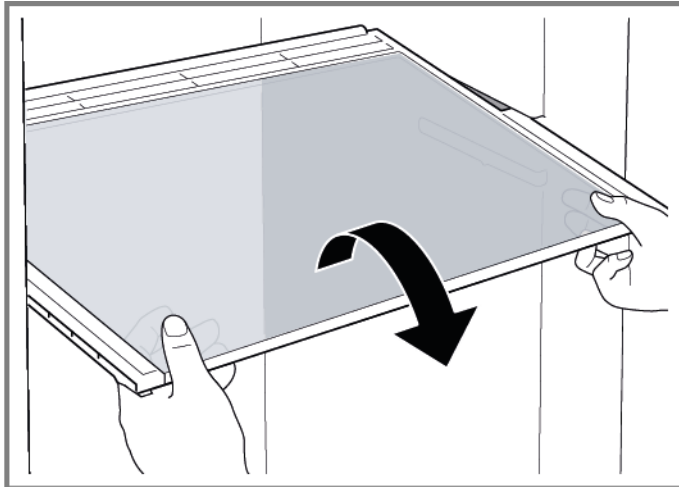

- ➡ Polica je uklonjena.

### 4.5.2 Postavljanje police

- ▶ Postavite obratnim redoslijedom.



## 4.6 Zamjena izvlačne police

### Zahtjev:

- ✔ Vrata su otvorena.

### 4.6.1 Uklanjanje izvlačne police

1. Izvlačite izvlačnu policu dok se blokirni element ne otpusti.

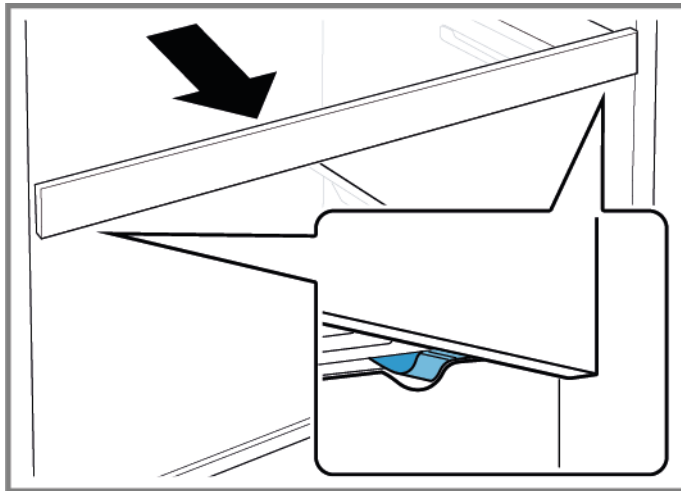

2. Spustite izvlačnu policu i zaokrenite je bočno.
3. ➡ Izvlačna je polica uklonjena.

### 4.6.2 Postavljanje izvlačne police

- ▶ Postavite obratnim redoslijedom.

## 4.7 Zamjena police odjeljka zamrzivača

### Zahtjev:

- ✔ Vrata su otvorena.

### 4.7.1 Uklanjanje police odjeljka zamrzivača

- ▶ Izvucite policu odjeljka zamrzivača.

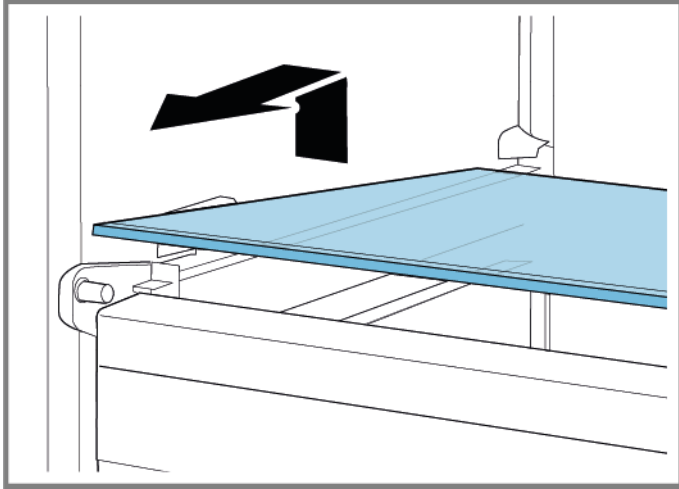

- ➡ Polica odjeljka zamrzivača je uklonjena.

### 4.7.2 Postavljanje police odjeljka zamrzivača

- ▶ Postavite obratnim redoslijedom.

## 4.8 Zamjena spremnika za zamrznute namirnice

### Zahtjev:

- ✔ Vrata su otvorena.

### 4.8.1 Uklanjanje spremnika za zamrznute namirnice

- ▶ 1. Potpuno izvucite spremnik za zamrznute namirnice (1).
- ▶ 2. Uklonite spremnik za zamrznute namirnice (2).

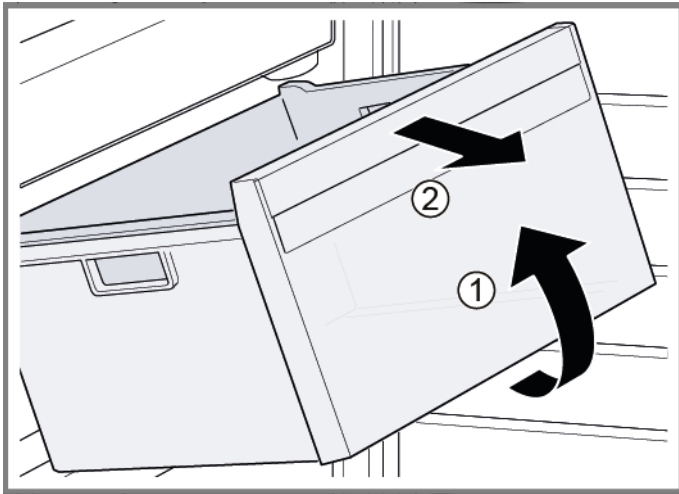

- ➡ Spremnik za zamrznute namirnice je uklonjen.

### 4.8.2 Postavljanje spremnika za zamrznute namirnice

- ▶ Postavite obratnim redoslijedom.

## 4.9 Zamjena spremnika za voće i povrće

### Zahtjev:

- ✔ Vrata su otvorena.

### 4.9.1 Uklanjanje spremnika za voće i povrće

- ▶ 1. Potpuno izvucite spremnik (1).
- ▶ 2. Uklonite spremnik (2).

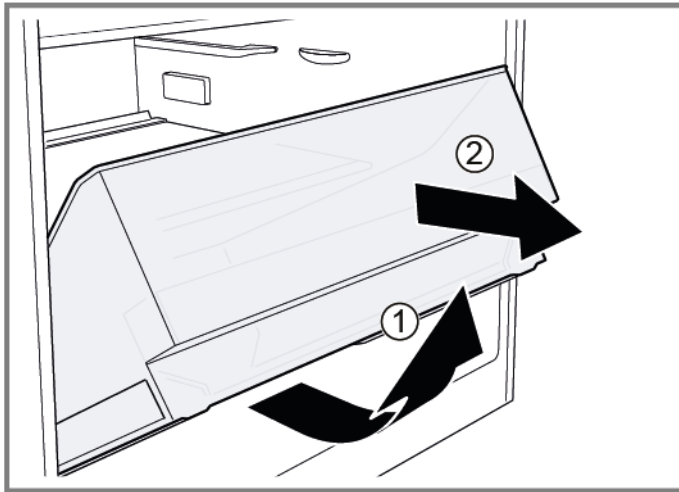

- ➡ Spremnik je uklonjen.

### 4.9.2 Postavljanje spremnika za voće i povrće

- ▶ Postavite obratnim redoslijedom.

## 4.10 Zamjena pregrade i poklopca spremnika za voće i povrće

### Zahtjev:

- ✔ Vrata su otvorena.

### 4.10.1 Uklanjanje pregrade i poklopca spremnika za voće i povrće

1. Uklonite staklenu ploču iz pregrade.

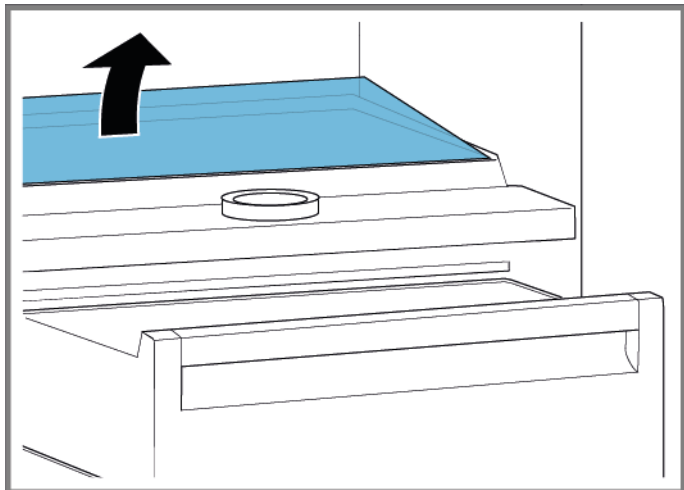

2. [Uklonite spremnik za voće i povrće. →44](#)

3. 1. Pritisnite polugu ispod obje strane pregrade (1).
2. Povucite pregradu prema naprijed (2).

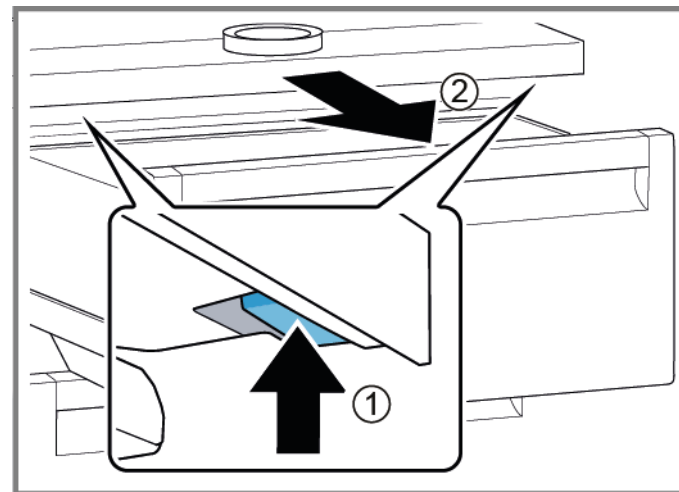

4. Podignite pregradu i zaokrenite je bočno prema van.  
➡ Pregrada je uklonjena.
5. 1. Podignite poklopac spremnika za voće i povrće.  
2. Povucite poklopac spremnika za voće i povrće prema naprijed i okrenite ga bočno.  
➡ Poklopac spremnika za voće i povrće je uklonjen.

### 4.10.2 Postavljanje pregrade i poklopca spremnika za voće i povrće

- ▶ Postavite obratnim redoslijedom.

## 4.11 Zamjena spremnika za održavanje svježine

### Zahtjev:

- ✔ Vrata su otvorena.

### 4.11.1 Uklanjanje spremnika za održavanje svježine

- ▶ 1. Nagnite spremnik za održavanje svježine prema naprijed (1).
- ▶ 2. Uklonite spremnik za održavanje svježine (2).

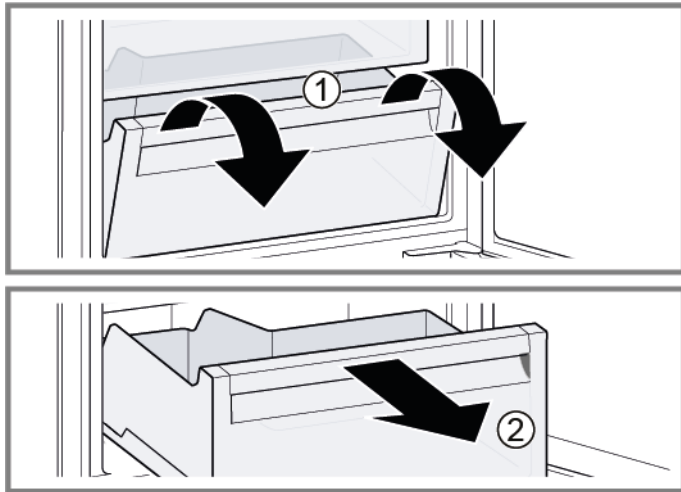

- ➡ Spremnik za održavanje svježine je uklonjen.

### 4.11.2 Postavljanje spremnika za održavanje svježine

- ▶ Postavite obratnim redoslijedom.

## 4.12 Zamjena izvlačnog spremnika

### Zahtjev:

- ✔ Vrata su otvorena.

### 4.12.1 Uklanjanje izvlačnog spremnika

- ▶ 1. Nagnite izvlačni spremnik prema naprijed (1).
- ▶ 2. Uklonite izvlačni spremnik (2).

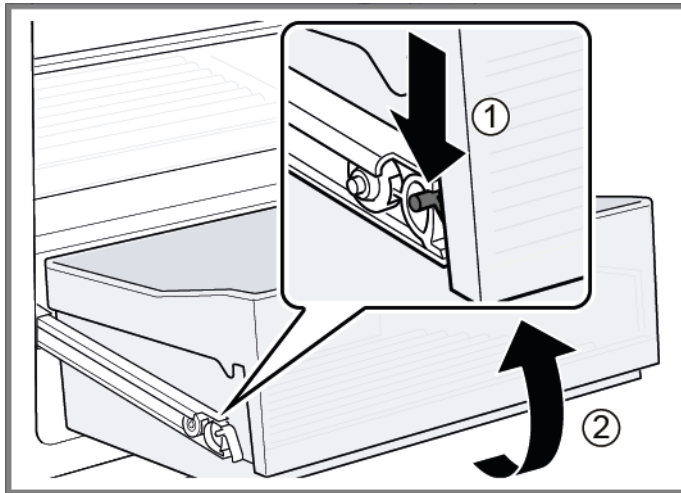

➡ Izvlačni spremnik je uklonjen.

### 4.12.2 Postavljanje izvlačnog spremnika

- ▶ Postavite obratnim redoslijedom.

## 4.13 Zamjena LED usmjerenog svjetla

### Specijalni alati:

- 🔧 Specijalni alat [00342180]
- 🔧 Odvijač s utorom Nož 2,4 mm x 0,4 mm x 60 mm, u kompletu [00341820]

 Uređaj ima svjetlo LED koje ne zahtijeva održavanje. Ta svjetla smije popravljati samo osoblje iz službe za korisnike ili ovlaštene tehničari!

 **⚠️ OPASNOST**  
**Opasnost od strujnog udara zbog dijelova koji provode struju!**  
U slučaju nepravilnog popravka može doći do opasnosti za život od strujnog udara

- ▶ Električne dijelove mora popraviti kvalificirani električar.
- ▶ Nakon popravka provedite sigurnosni test u skladu s VDE 0701 ili nacionalnim propisima.

 **⚠️ OPASNOST**  
**Opasnost od strujnog udara zbog dijelova koji provode struju!**  
Smrt od strujnog udara

- ▶ Isključite uređaj iz električnog napajanja najmanje 60 sekundi prije izvođenja popravka.

 **⚠️ OPREZ**  
**Oštri rubovi!**  
Porezotine

- ▶ Nosite zaštitne rukavice.

### Zahtjev:

- ✔ Uređaj je isključen iz napajanja.
- ✔ Vrata su otvorena.
- ✔ Police odjeljka hladnjaka su uklonjene.

## 4.13.1 Uklanjanje LED usmjerenog svjetla

1. Otpustite poklopac LED usmjerenog svjetla.

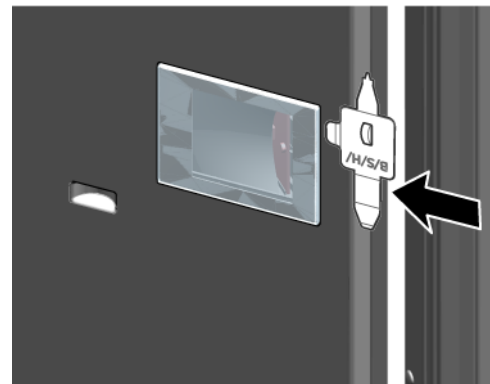

2. Povucite poklopac LED usmjerenog svjetla prema unutra i istodobno ga gurnite prema naprijed.

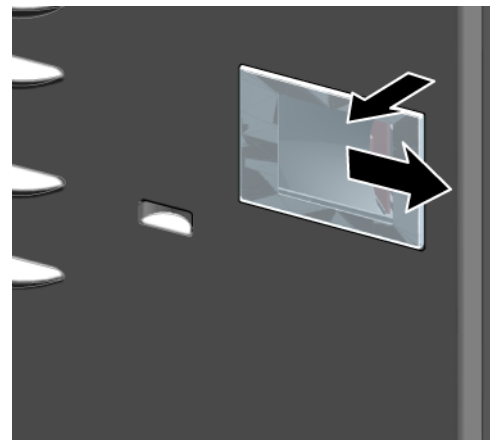



3. Odvojite modul LED usmjerenog svjetla.

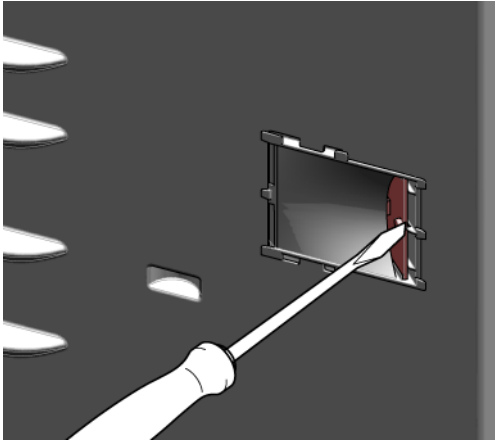

4. Odvojite električni priključak LED usmjerenog svjetla.

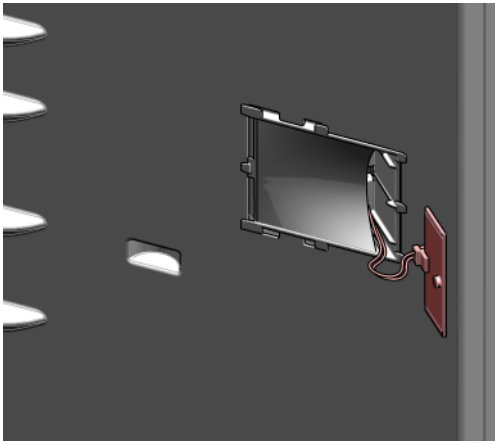





- ➔ LED usmjerenno svjetlo je uklonjeno.

### 4.13.2 Postavljanje LED usmjerenog svjetla

- ▶ Postavite obratnim redoslijedom.

# Poznámky k opravě - Kombinace chladničky s mrazničkou

 <b>O tomto dokumentu</b> .....	<b>51</b>	4.8	Výměna zásobníku na zmrazené potraviny .....	67
1.1 Důležité informace .....	51	4.8.1	Vyjmutí zásobníku na zmrazené potraviny .....	67
1.1.1 Účel .....	51	4.8.2	Montáž zásobníku na zmrazené potraviny .....	67
1.2 Vysvětlení symbolů .....	51	4.9	Výměna zásobníku na ovoce a zeleninu .....	68
1.2.1 Úroveň nebezpečí .....	51	4.9.1	Vyjmutí zásobníku na ovoce a zeleninu .....	68
1.2.2 Symboly nebezpečí .....	51	4.9.2	Montáž zásobníku na ovoce a zeleninu .....	68
1.2.3 Struktura výstrah .....	52	4.10	Výměna příčky a víka zásobníku na ovoce a zeleninu .....	69
1.2.4 Obecné symboly .....	52	4.10.1	Vyjmutí příčky a víka zásobníku na ovoce a zeleninu .....	69
 <b>Bezpečnost</b> .....	<b>53</b>	4.10.2	Montáž příčky a víka zásobníku na ovoce a zeleninu .....	69
2.1 Všeobecné bezpečnostní pokyny .....	53	4.11	Výměna zásobníku na čerstvé potraviny .....	70
2.1.1 Všechny domácí spotřebiče .....	53	4.11.1	Vyjmutí zásobníku na čerstvé potraviny .....	70
 <b>Nástroje a pomůcky</b> .....	<b>54</b>	4.11.2	Montáž zásobníku na čerstvé potraviny .....	70
 <b>Oprava</b> .....	<b>55</b>	4.12	Výměna výsuvného zásobníku .....	71
4.1 Výměna těsnění dvířek .....	55	4.12.1	Vyjmutí výsuvného zásobníku .....	71
4.1.1 Vyjmutí těsnění dvířek .....	55	4.12.2	Montáž výsuvného zásobníku .....	71
4.1.2 Montáž těsnění dvířek .....	55	4.13	Výměna LED bodového osvětlení .....	72
4.2 Výměna plochých pantů .....	58	4.13.1	Vyjmutí LED bodového osvětlení .....	72
4.2.1 Odstranění plochých pantů .....	58	4.13.2	Montáž LED bodového osvětlení .....	73
4.2.2 Montáž plochých pantů .....	60			
4.3 Výměna posuvných závěsů .....	61			
4.3.1 Odstranění posuvných závěsů .....	61			
4.3.2 Montáž posuvných závěsů .....	62			
4.4 Výměna dveřní přihrádky .....	63			
4.4.1 Vyjmutí dveřní přihrádky .....	63			
4.4.2 Montáž dveřní přihrádky .....	63			
4.5 Výměna odkládací plochy .....	64			
4.5.1 Vyjmutí odkládací plochy .....	64			
4.5.2 Montáž odkládací plochy .....	64			
4.6 Výměna výsuvné odkládací plochy .....	65			
4.6.1 Vyjmutí výsuvné odkládací plochy .....	65			
4.6.2 Montáž výsuvné odkládací plochy .....	65			
4.7 Výměna odkládací plochy mrazicí přihrádky .....	66			
4.7.1 Vyjmutí odkládací plochy mrazicí přihrádky .....	66			
4.7.2 Montáž odkládací plochy mrazicí přihrádky .....	66			

# **i** O tomto dokumentu

## 1.1 Důležité informace

### 1.1.1 Účel

Tyto pokyny k opravě pomáhají spotřebiteli při vlastnoruční opravě spotřebičů v souladu s platnými předpisy o ekodesignu (platnými k 03/2021).



Obsahují informace o výměně některých náhradních dílů včetně příslušných výstrah a nebezpečí.

V případě dotazů se obraťte na náš zákaznický servis. Za škody ručíme pouze v případě, že budou správně dodrženy pokyny k opravě.

## 1.2 Vysvětlení symbolů

### 1.2.1 Úroveň nebezpečí

Jednotlivé úrovně výstrah se skládají ze symbolu a signálního slova. Signální slova uvádějí závažnost nebezpečí.





Úroveň výstrahy	Význam
 <b>NEBEZPEČÍ</b>	Nedodržení výstražného upozornění způsobí smrt nebo vážná zranění.
 <b>VÝSTRAHA</b>	Nedodržení výstražného upozornění může způsobit smrt nebo vážná zranění.
 <b>POZOR</b>	Nedodržení výstražného upozornění může způsobit lehká zranění.
<b>POZOR!</b>	Nedodržení výstražného upozornění může způsobit škody na majetku.

Tabulka 1: Úroveň nebezpečí



### 1.2.2 Symboly nebezpečí

Symboly nebezpečí jsou symbolická znázornění určující druh nebezpečí.

V tomto dokumentu jsou použity následující symboly nebezpečí:

Symbol nebezpečí	Význam
	Obecné výstražné upozornění
	Nebezpečí vycházející z elektrického napětí
	Nebezpečí výbuchu
	Nebezpečí pořezání
	Nebezpečí rozdrcení



## O tomto dokumentu

Symbol nebezpečí	Význam
	Nebezpečí spojené s horkými povrchy
	Nebezpečí vycházející ze silného elektromagnetického pole
	Nebezpečí z neionizujícího záření

Tabulka 2: Symboly nebezpečí

### 1.2.3 Struktura výstrah

Výstrahy použité v tomto dokumentu mají standardizovaný vzhled a strukturu.



	<div style="background-color: red; color: white; padding: 2px; text-align: center;"> <b>NEBEZPEČÍ</b></div> <p><b>Typ a zdroj nebezpečí!</b> Možné důsledky nedodržení výstražného upozornění.</p> <ul style="list-style-type: none"> <li>▶ Opatření a zákazy eliminující nebezpečí.</li> </ul>
--	--





Následující příklad ukazuje výstrahu, která varuje před zásahem elektrickým proudem při dotyku dílů pod proudem. Je uvedeno opatření pro zabránění rizika.

	<div style="background-color: red; color: white; padding: 2px; text-align: center;"> <b>NEBEZPEČÍ</b></div> <p><b>Nebezpečí úrazu elektrickým proudem při dotyku dílů pod proudem!</b> Usmrcení elektrickým proudem</p> <ul style="list-style-type: none"> <li>▶ Odpojte spotřebič od přívodu elektrického proudu alespoň 60 sekund před zahájením opravy.</li> </ul>
---	--

### 1.2.4 Obecné symboly

V tomto dokumentu jsou použity následující obecné symboly:

Obecný symbol	Význam
	Uvedení zvláštního tipu (text nebo grafické vyjádření)
	Uvedení jednoduchého tipu (pouze text)
	Uvedení odkazu k videonávodu

Obecný symbol	Význam
	Uvedení požadovaných nástrojů
	Uvedení požadovaných podmínek
	Uvedení podmínky (když, pak atd.)
	Uvedení výsledku
[Start]	Uvedení klávesy nebo tlačítka
[00123456]	Uvedení čísla materiálu
Status	Uvedení zobrazeného textu / okna (na ukazateli spotřebiče)

Tabulka 3: Obecné symboly

## **2.1 Všeobecné bezpečnostní pokyny**

### **2.1.1 Všechny domácí spotřebiče**

#### **Nebezpečí úrazu elektrickým proudem při dotyku dílů pod proudem!**

- Chyby při opravě elektrických součástí mohou vést k úrazu elektrickým proudem!
- Odpojte spotřebič ze sítě alespoň 60 sekund před zahájením prací.
- Po opravě nechte provést bezpečnostní zkoušku podle VDE 0701 nebo specifických předpisů dané země.

#### **Nebezpečí poranění o ostré hrany!**

- Používejte ochranné rukavice.

#### **Nebezpečí rozdrčení během opravy, údržby, odstranění závad a servisu těžkými a pohyblivými součástmi**

- Používejte bezpečnostní obuv.
- Zajistěte těžké součásti před pádem.
- Nesahejte na pohyblivé součásti.



#### **Nebezpečí z hlediska bezpečnosti / funkce spotřebiče!**

- Používejte pouze originální náhradní díly.

#### **Nebezpečí poškození elektrostaticky citlivých součástí (elektrostatický výboj)!**

- Nedotýkejte se modulů, včetně přípojek a vodičů.

## Nástroje a pomůcky

Označení	Detaily	Snímky
Ochranná tkanina [00342013]	60 cm x 50 cm	
Torx Bit TX20 [00340865]	6,3 mm (1/4")	
Speciální nástroj [00342180]		

## 4.1 Výměna těsnění dvířek

### Požadavek:

- ✔ Dvířka jsou otevřená.

### 4.1.1 Vyjmutí těsnění dvířek

1. Uvolněte těsnění dvířek z drážky v pravém a levém rohu.

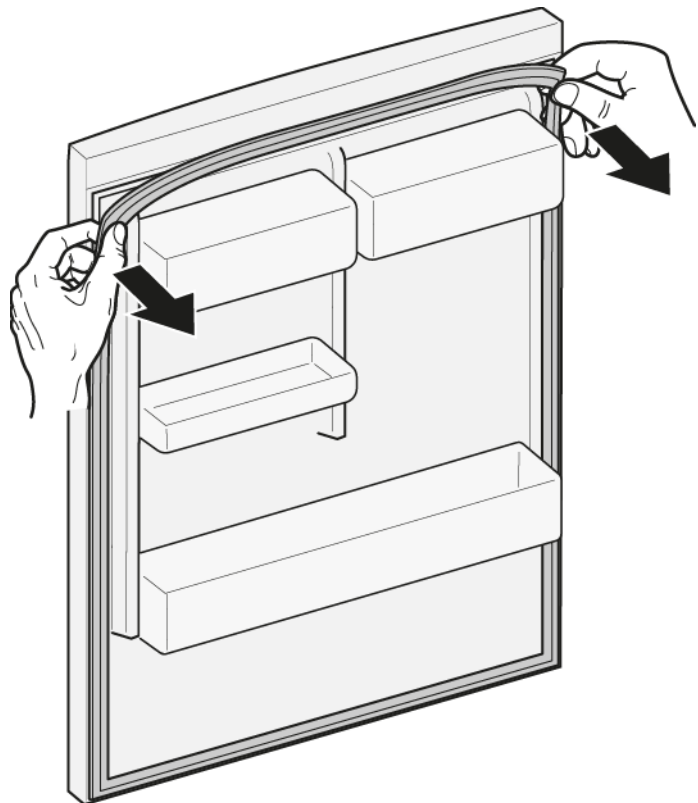

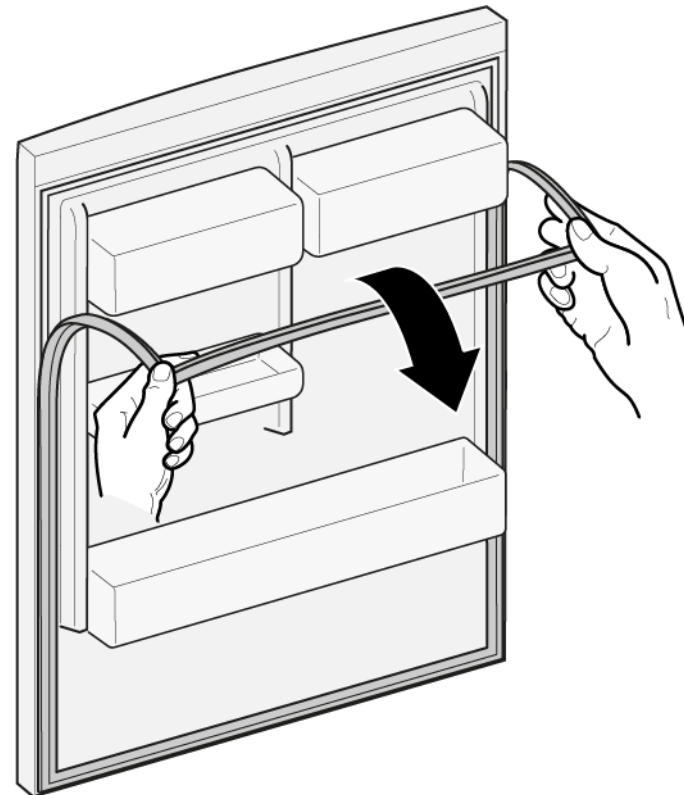

2. Vytáhněte těsnění z drážky.



- ➡ Těsnění dvířek je vyjmuté.

### 4.1.2 Montáž těsnění dvířek

	Nové těsnění dvířek může mít trochu jinou šířku než původní těsnění. Dovření dvířek ani dlouhodobá funkce tím nebudou ovlivněny.
	Pokud má spotřebič nastavitelné závěsy nebo nástavce závěsů, můžete dovření dvířek následně upravit.
	Malé boční otvory v těsnění dvířek jsou funkční (slouží pro přívod vzduchu). Nejsou vadou výrobku.

1. Zkontrolujte, zda není poškozena drážka těsnění.

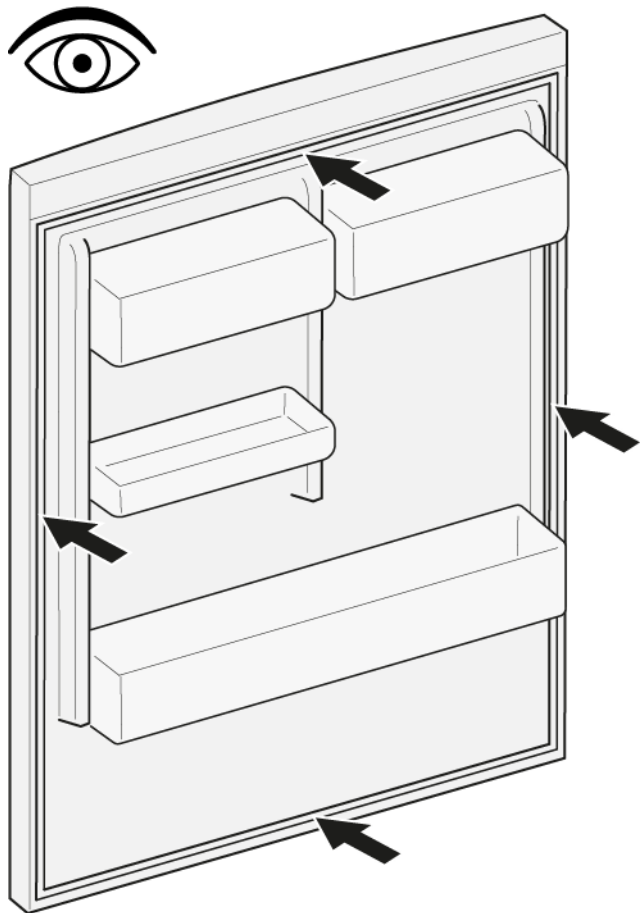

4. Zatlačte horní a dolní rohy těsnění do drážky.

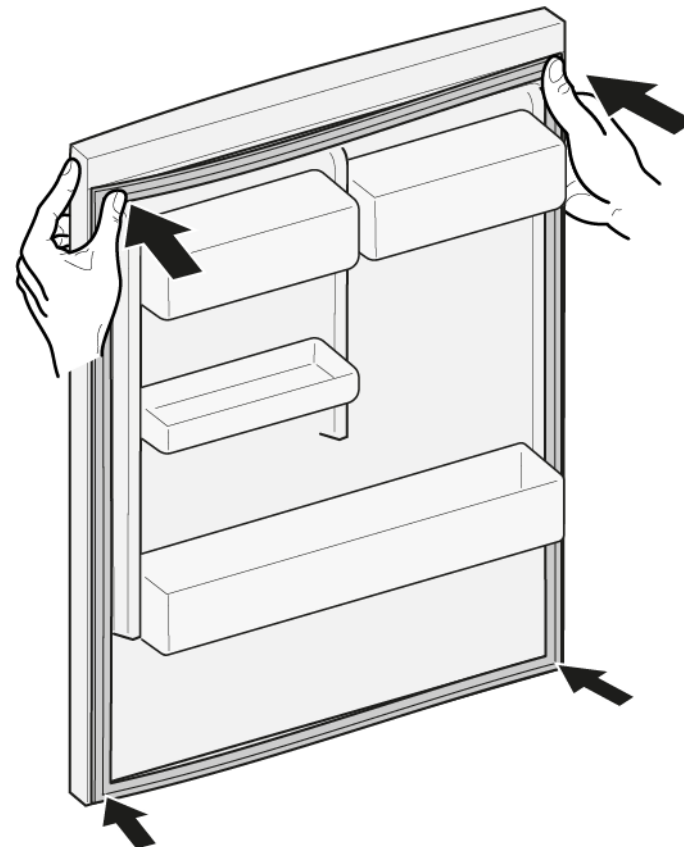

2.  Pokud je drážka těsnění poškozená,  
- kontaktujte zákaznický servis.

3.  Lehká deformace těsnění dvířek je normální a nemá vliv na jeho funkci. Před vložením do spotřebiče doporučujeme těsnění narovnat.

Těsnění zahřejte fénem nebo horkou vodou a manuálně upravte jeho tvar.



5. Postupně zatlačte do drážky celé těsnění.

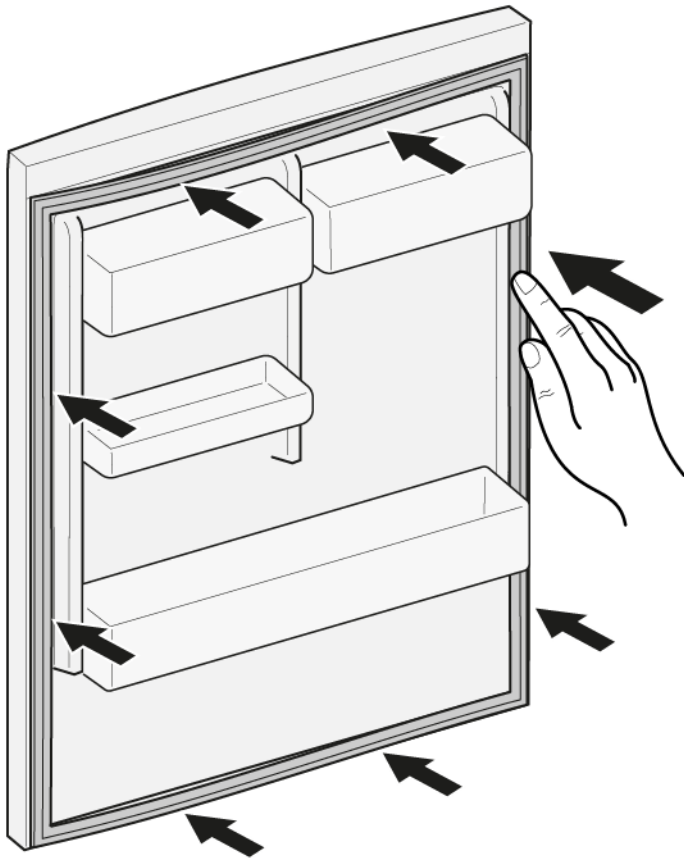

 Těsnění dvířek je namontované.

## 4.2 Výměna plochých pantů

Speciální nástroje:

 Torx Bit TX20

6,3 mm (1/4")

[00340865]

	<b>⚠ VÝSTRAHA</b>
	<p><b>Těžké, objemné spotřebiče!</b> Poranění zad a svalů</p> <ul style="list-style-type: none"> <li>▶ Odstranění dvířek spotřebiče by měl provádět výhradně školený odborník.</li> <li>▶ Pro manipulaci se spotřebičem jsou nutní dva lidé.</li> <li>▶ Použijte pouze vhodné nástroje a zařízení.</li> </ul>



	<b>⚠ POZOR</b>
	<p><b>Ostré hrany!</b> Nebezpečí řezných poranění</p> <ul style="list-style-type: none"> <li>▶ Používejte ochranné rukavice.</li> </ul>

	<b>⚠ POZOR</b>
	<p><b>Otevřete prostor se závěsy!</b> Rozdrcení prstů / zachycení</p> <ul style="list-style-type: none"> <li>▶ Nesahejte do prostoru se závěsy.</li> <li>▶ Používejte ochranné rukavice.</li> </ul>

	<b>⚠ POZOR</b>
	<p><b>Nebezpečí padajících dílů kvůli uvolněným šroubům!</b> Poranění padajícími díly.</p> <ul style="list-style-type: none"> <li>▶ Zajistěte jednotlivé součásti před pádem.</li> </ul>

	<b>POZOR!</b>
	<p><b>Nebezpečí padajících dílů kvůli uvolněným šroubům!</b> Poškození jiných částí spotřebiče nebo prvků domácnosti zákazníka, např. podlahy.</p> <ul style="list-style-type: none"> <li>▶ Zajistěte jednotlivé součásti před pádem.</li> </ul>

Požadavek:

-  Spotřebič je odpojený od přívodu elektrické energie.
-  Čelní dvířka nábytku jsou vyjmutá. Viz návod k montáži.
-  Dvířka jsou otevřená.

### 4.2.1 Odstranění plochých pantů

Dbejte na to, abyste panty během demontáže / montáže nezavřeli.



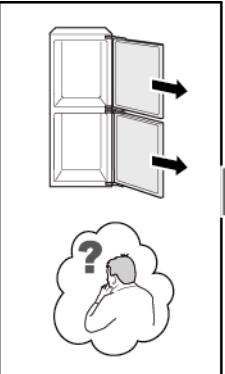
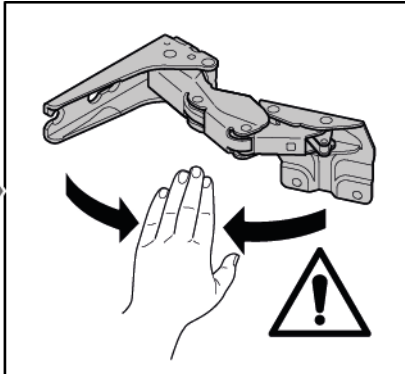

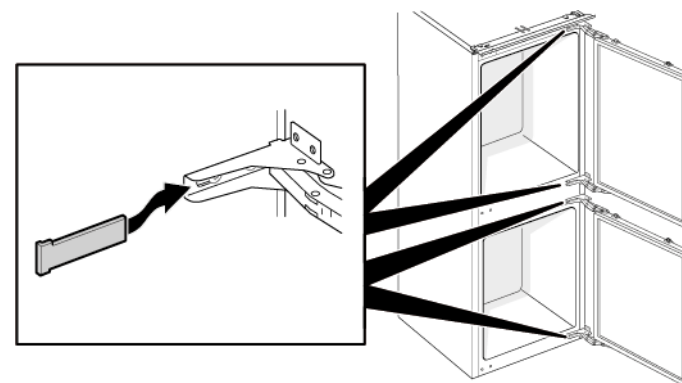

1. Sejměte čtyři kryty pantů.

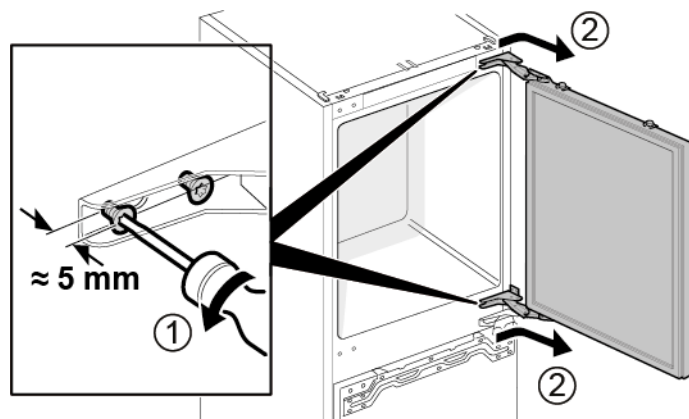

## Oprava

2. 1. Uvolněte čtyři šrouby (1).  
2. Vysuňte a vyjměte horní dvířka (2).



3. 1. Odstraňte čtyři šrouby (1).  
2. Vyměňte panty (2).

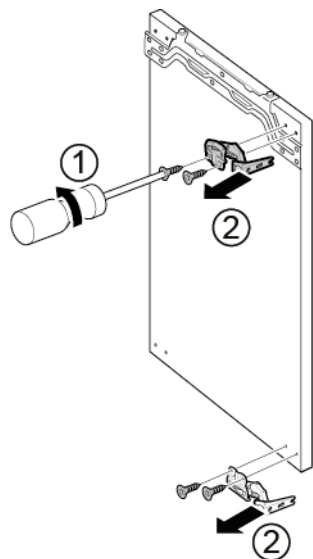

 Horní panty dvířek jsou vyjmuté.

4. 1. Uvolněte čtyři šrouby (1).  
2. Vysuňte a vyjměte spodní dvířka (2).

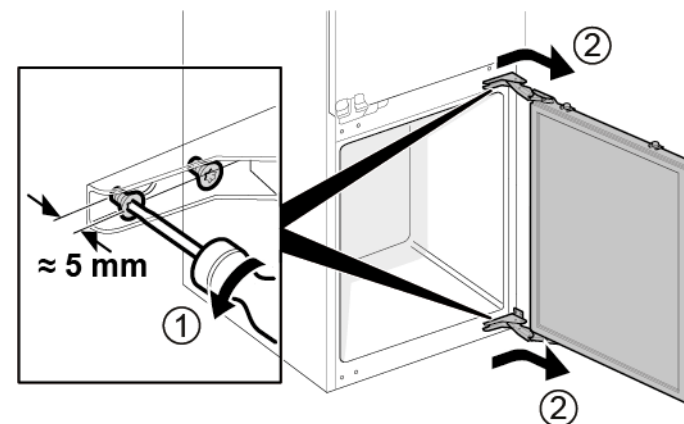

5. 1. Odstraňte čtyři šrouby (1).  
2. Vyměňte panty (2).

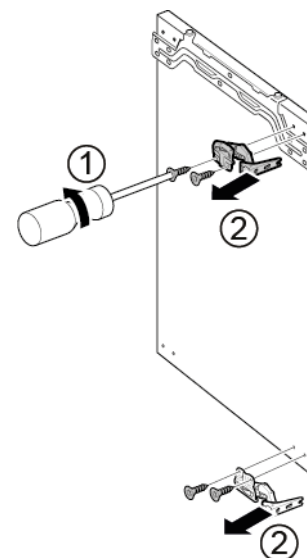

 Spodní panty dvířek jsou vyjmuté.

#### **4.2.2 Montáž plochých pantů**

- ▶ Montáž provedte v opačném sledu.

### 4.3 Výměna posuvných závěsů

**Speciální nástroje:**

 Torx Bit TX20                      6,3 mm (1/4")                      [00340865]



	<b>⚠ VÝSTRAHA</b>
	<p><b>Těžké, objemné spotřebiče!</b> Poranění zad a svalů</p> <ul style="list-style-type: none"> <li>▶ Odstranění dvířek spotřebiče by měl provádět výhradně školený odborník.</li> <li>▶ Pro manipulaci se spotřebičem jsou nutní dva lidé.</li> <li>▶ Použijte pouze vhodné nástroje a zařízení.</li> </ul>

	<b>⚠ POZOR</b>
	<p><b>Ostré hrany!</b> Nebezpečí řezných poranění</p> <ul style="list-style-type: none"> <li>▶ Používejte ochranné rukavice.</li> </ul>

	<b>⚠ POZOR</b>
	<p><b>Nebezpečí padajících dílů kvůli uvolněným šroubům!</b> Poranění padajícími díly.</p> <ul style="list-style-type: none"> <li>▶ Zajistěte jednotlivé součásti před pádem.</li> </ul>

	<b>POZOR!</b>
	<p><b>Nebezpečí padajících dílů kvůli uvolněným šroubům!</b> Poškození jiných částí spotřebiče nebo prvků domácnosti zákazníka, např. podlahy.</p> <ul style="list-style-type: none"> <li>▶ Zajistěte jednotlivé součásti před pádem.</li> </ul>

**Požadavek:**

-  Spotřebič je odpojený od přívodu elektrické energie.
-  Čelní dvířka nábytku a dvířka spotřebiče jsou oddělené. Viz návod k montáži.

#### 4.3.1 Odstranění posuvných závěsů

1. Vyšroubujte dva šrouby (1).
2. Vyměňte horní závěs horních dvířek (2).
3. Vyměňte horní dvířka (3).
4. Vyšroubujte dva šrouby (4).
5. Vyměňte horní závěs dolních dvířek (5).
6. Vyměňte dolní dvířka (6).

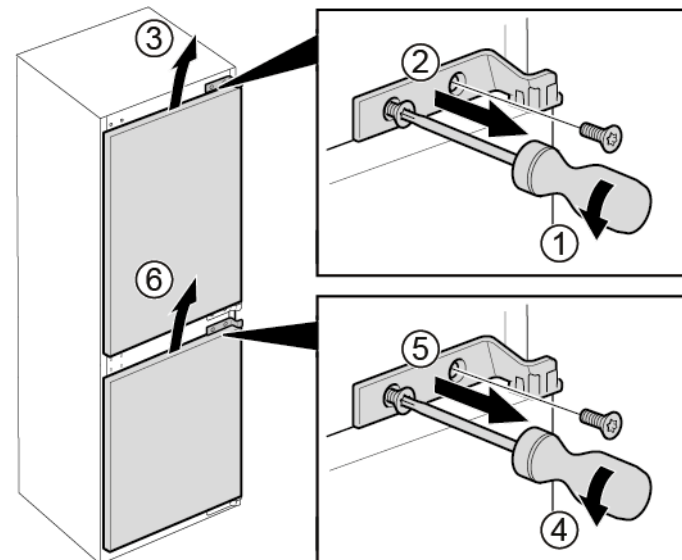

## Oprava

2. 1. Odstraňte čtyři šrouby (1).
2. Vyměňte spodní závěsy (2).

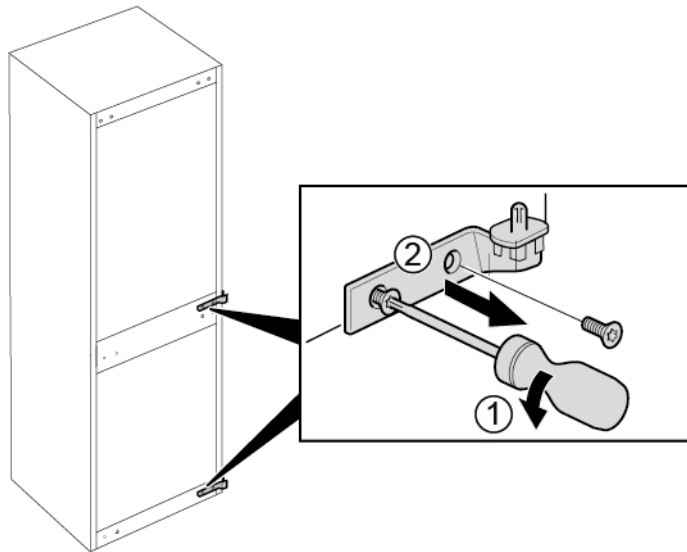

 Závěsy jsou vyjmuté.

### 4.3.2 Montáž posuvných závěsů

- ▶ Montáž proveďte v opačném sledu.

## 4.4 Výměna dveřní přihrádky

### Požadavek:

- ✔ Dvířka jsou otevřená.

### 4.4.1 Vyjmutí dveřní přihrádky

- ▶ Zvedněte dveřní přihrádku nahoru.

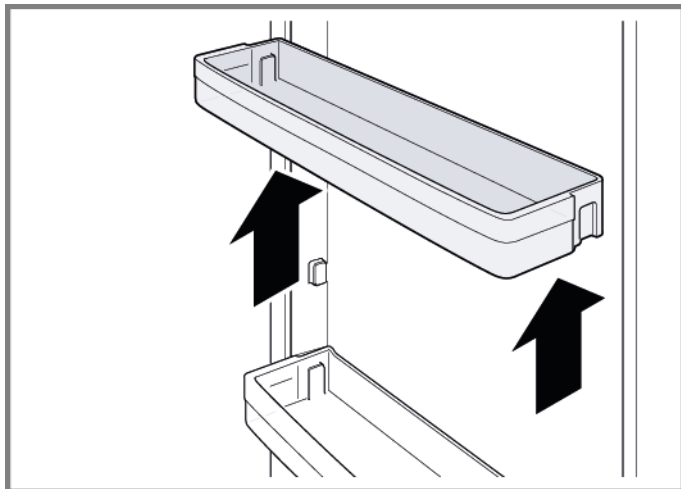

- ➡ Dveřní přihrádka je vyjmutá.

### 4.4.2 Montáž dveřní přihrádky

- ▶ Montáž proveďte v opačném sledu.

## 4.5 Výměna odkládací plochy

### Požadavek:

- ✔ Dvířka jsou otevřená.

### 4.5.1 Vyjmutí odkládací plochy

- ▶ Vytáhněte odkládací plochu.

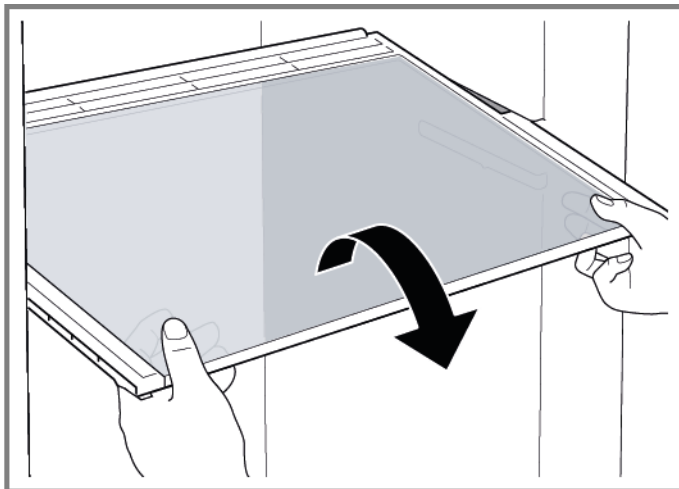

- ➡ Odkládací plocha je vyjmutá.

### 4.5.2 Montáž odkládací plochy

- ▶ Montáž proveďte v opačném sledu.



## 4.6 Výměna výsuvné odkládací plochy

### Požadavek:

- ✔ Dvířka jsou otevřená.

### 4.6.1 Vyjmutí výsuvné odkládací plochy

1. Vytáhněte výsuvnou odkládací plochu tak, aby se uvolnila západka.

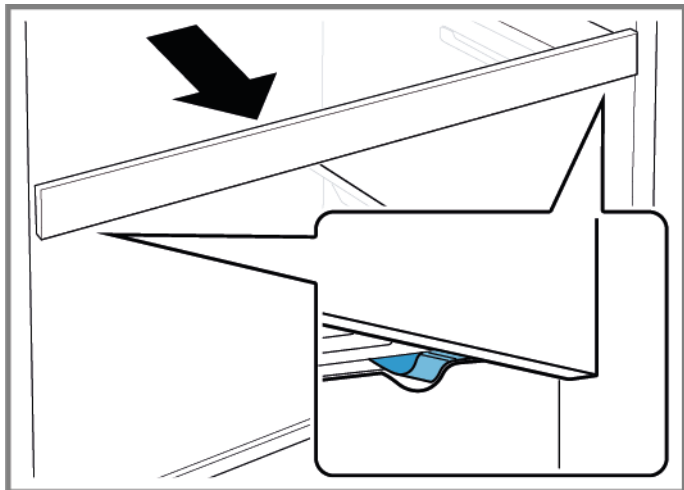

2. Posuňte výsuvnou odkládací plochu dolů a vysuňte ji do strany.
3. ➡ Výsuvná odkládací plocha je vyjmutá.

### 4.6.2 Montáž výsuvné odkládací plochy

- ▶ Montáž provedte v opačném sledu.

## 4.7 Výměna odkládací plochy mrazicí přihrádky

### Požadavek:

- ✔ Dvířka jsou otevřená.

### 4.7.1 Vyjmutí odkládací plochy mrazicí přihrádky

- ▶ Vytáhněte odkládací plochu mrazicí přihrádky.

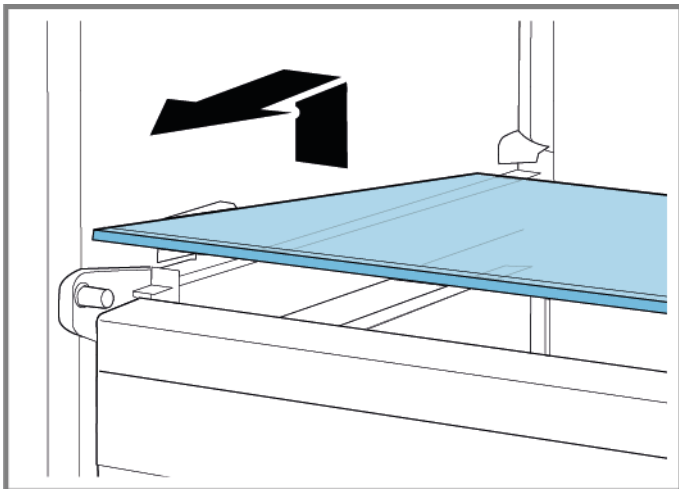

- ➡ Odkládací plocha mrazicí přihrádky je vyjmutá.

### 4.7.2 Montáž odkládací plochy mrazicí přihrádky

- ▶ Montáž provedte v opačném sledu.

## 4.8 Výměna zásobníku na zmrazené potraviny

### Požadavek:

- ✔ Dvířka jsou otevřená.

### 4.8.1 Vyjmutí zásobníku na zmrazené potraviny

- ▶ 1. Úplně vytáhněte zásobník na zmrazené potraviny (1).
- ▶ 2. Vyjměte zásobník na zmrazené potraviny (2).

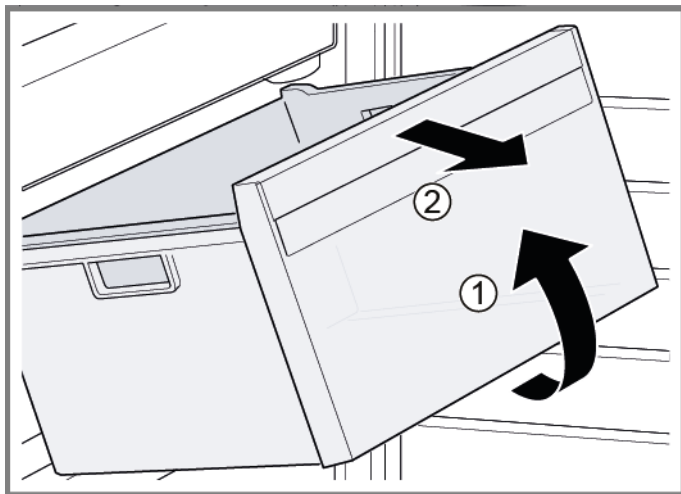

- ➡ Zásobník na zmrazené potraviny je vyjmutý.

### 4.8.2 Montáž zásobníku na zmrazené potraviny

- ▶ Montáž proveďte v opačném sledu.

## 4.9 Výměna zásobníku na ovoce a zeleninu

### Požadavek:

- ✔ Dvířka jsou otevřená.

### 4.9.1 Vyjmutí zásobníku na ovoce a zeleninu

- ▶ 1. Úplně vytáhněte zásobník (1).
- ▶ 2. Vyjměte zásobník (2).

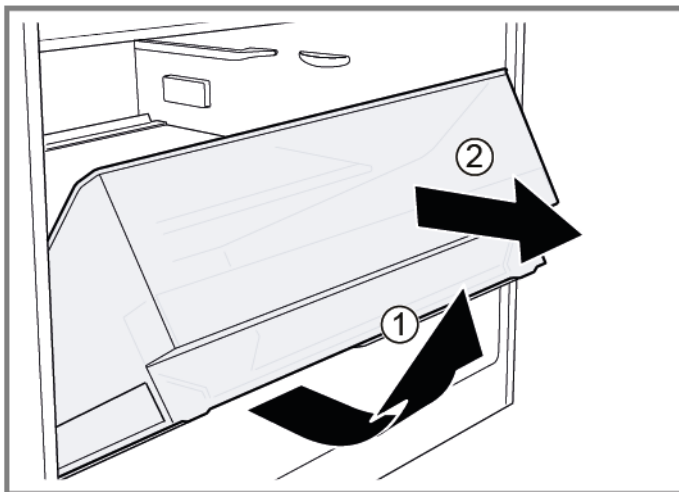

- ➡ Zásobník je vyjmutý.

### 4.9.2 Montáž zásobníku na ovoce a zeleninu

- ▶ Montáž proveďte v opačném sledu.

## 4.10 Výměna příčky a víka zásobníku na ovoce a zeleninu

### Požadavek:

- ✔ Dvířka jsou otevřená.

### 4.10.1 Vyjmutí příčky a víka zásobníku na ovoce a zeleninu

1. Vyjměte z příčky skleněnou desku.

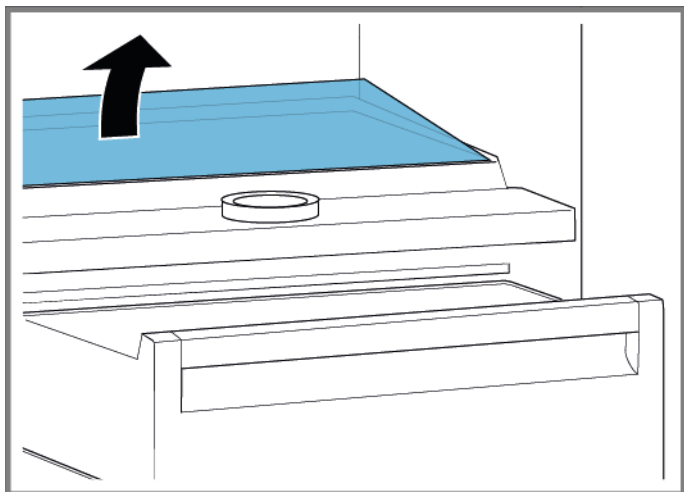

2. [Vyjměte zásobník na ovoce a zeleninu.→68](#)

3. 1. Stiskněte páčku dole na obou stranách příčky (1).
2. Vytáhněte příčku dopředu (2).

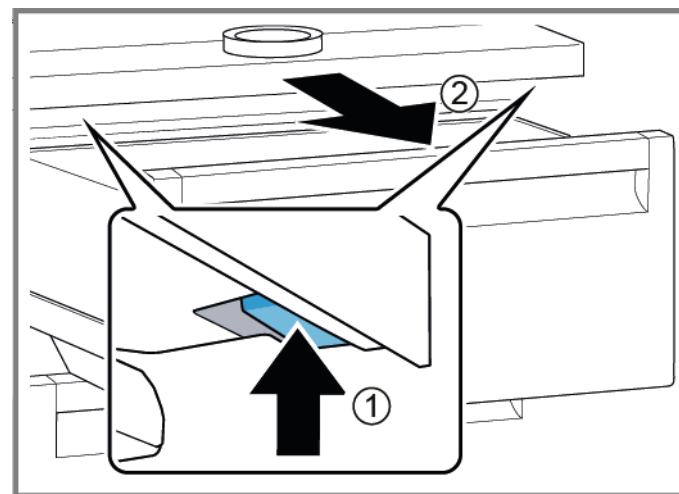

4. Zvedněte příčku a vytočte ji do strany.  
➡ Příčka je vyjmutá.
5. 1. Zvedněte víko zásobníku na ovoce a zeleninu.  
2. Vytáhněte víko zásobníku na ovoce a zeleninu dopředu a vytočte jej do strany.  
➡ Víko zásobníku na ovoce a zeleninu je vyjmuté.

### 4.10.2 Montáž příčky a víka zásobníku na ovoce a zeleninu

- ▶ Montáž provedte v opačném sledu.

## 4.11 Výměna zásobníku na čerstvé potraviny

### Požadavek:

- ✔ Dvířka jsou otevřená.

### 4.11.1 Vyjmutí zásobníku na čerstvé potraviny

- ▶ 1. Nakloňte zásobník na čerstvé potraviny dopředu (1).
- ▶ 2. Vyjměte zásobník na čerstvé potraviny (2).

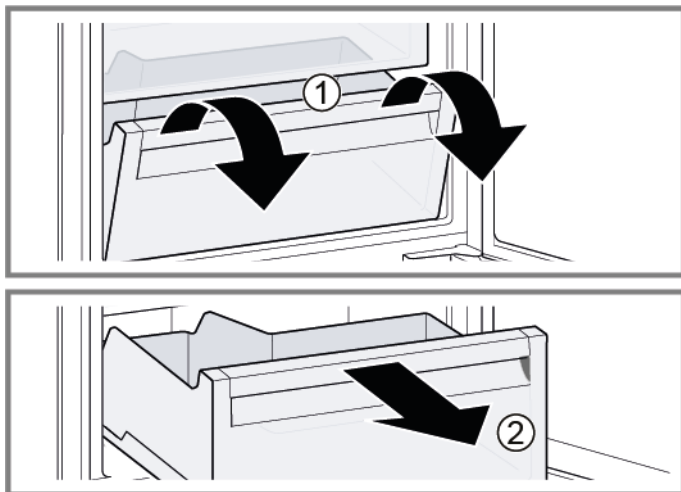

- ➡ Zásobník na čerstvé potraviny je vyjmutý.

### 4.11.2 Montáž zásobníku na čerstvé potraviny

- ▶ Montáž proveďte v opačném sledu.

## 4.12 Výměna výsuvného zásobníku

### Požadavek:

- ✔ Dvířka jsou otevřená.

### 4.12.1 Vyjmutí výsuvného zásobníku

- ▶ 1. Nakloňte výsuvný zásobník dopředu (1).
- ▶ 2. Vyjměte výsuvný zásobník (2).

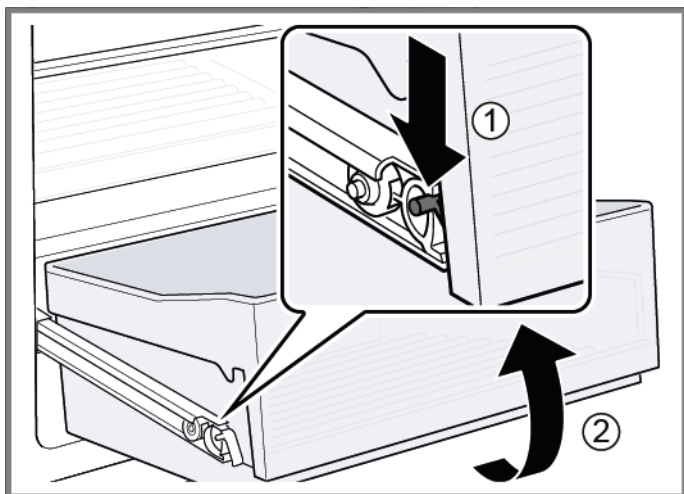



➡ Výsuvný zásobník je vyjmutý.

### 4.12.2 Montáž výsuvného zásobníku

- ▶ Montáž proveďte v opačném sledu.

## 4.13 Výměna LED bodového osvětlení

### Speciální nástroje:

-  Speciální nástroj [00342180]
-  Plochý šroubovák Čepel 2,4 mm x 0,4 mm x 60 mm, v sadě [00341820]



	Váš spotřebič je vybaven bezúdržbovým LED osvětlením. Tato osvětlení smí být opravena pouze zákaznickým servisem nebo oprávněným technikem!
---	---

	<b>⚠ NEBEZPEČÍ</b>
<b>Nebezpečí úrazu elektrickým proudem při dotyku dílů pod proudem!</b>	
V případě neodborné opravy hrozí nebezpečí smrtelného úrazu elektrickým proudem	
<ul style="list-style-type: none"> <li>▶ Opravu elektrického zařízení smí provádět jen kvalifikovaný elektrikář.</li> <li>▶ Po opravě nechte provést bezpečnostní zkoušku podle VDE 0701 nebo specifických předpisů dané země.</li> </ul>	

	<b>⚠ NEBEZPEČÍ</b>
<b>Nebezpečí úrazu elektrickým proudem při dotyku dílů pod proudem!</b>	
Usmrcení elektrickým proudem	
<ul style="list-style-type: none"> <li>▶ Odpojte spotřebič od přívodu elektrického proudu alespoň 60 sekund před zahájením opravy.</li> </ul>	

	<b>⚠ POZOR</b>
<b>Ostré hrany!</b>	
Nebezpečí řezných poranění	
<ul style="list-style-type: none"> <li>▶ Používejte ochranné rukavice.</li> </ul>	

### Požadavek:

-  Spotřebič je odpojený od přívodu elektrické energie.
-  Dvířka jsou otevřená.
-  Odkládací plochy chladičů přihrádky jsou vyjmuté.

### 4.13.1 Vyjmutí LED bodového osvětlení

1. Uvolněte kryt LED bodového osvětlení.

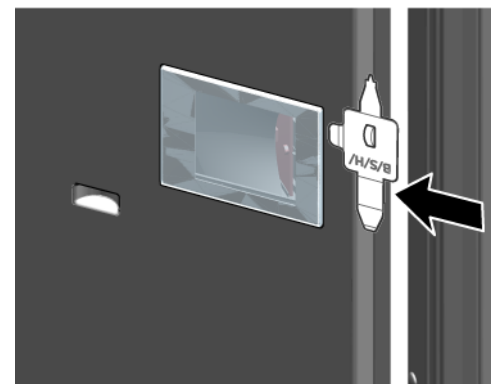

2. Zatáhněte kryt LED bodového světla dovnitř a současně jej vytlačte dopředu.

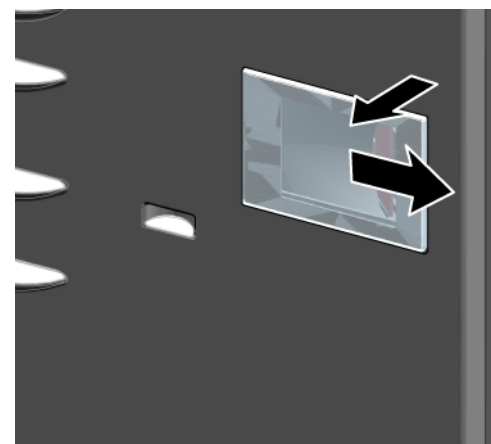



3. Odpojte modul LED bodového osvětlení.

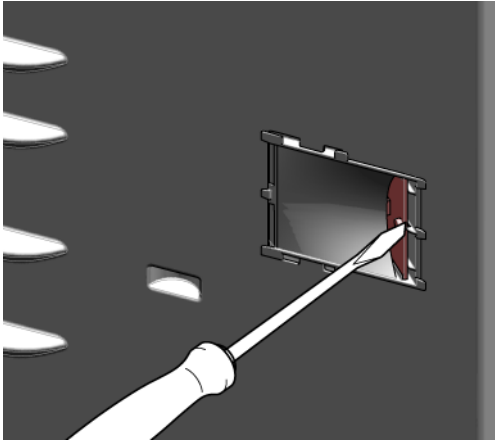

4. Odpojte elektrické připojení LED bodového osvětlení.

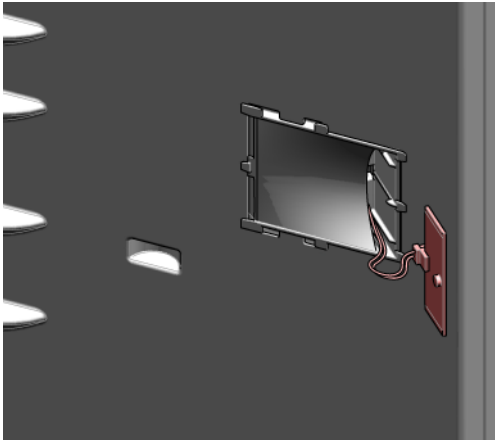





 LED bodové osvětlení je vyjmuté.

### 4.13.2 Montáž LED bodového osvětlení

- ▶ Montáž provedte v opačném sledu.

# Tip til reparation - Køle-/ frysekombination

 <b>Om dette dokument</b> .....	<b>75</b>
1.1 Vigtig information.....	75
1.1.1 Formål.....	75
1.2 Forklaring af symboler .....	75
1.2.1 Fareniveauer .....	75
1.2.2 Faresymboler.....	75
1.2.3 Advarslernes opbygning .....	76
1.2.4 Generelle symboler .....	76
 <b>Sikkerhed</b> .....	<b>77</b>
2.1 Generelle sikkerhedsanvisninger .....	77
2.1.1 Alle husholdningsapparater .....	77
 <b>Værktøjer og hjælpemidler</b> .....	<b>78</b>
 <b>Reparation</b> .....	<b>79</b>
4.1 Udskiftning af dørpakning.....	79
4.1.1 Fjernelse af dørpakning.....	79
4.1.2 Montering af dørpakning.....	79
4.2 Udskiftning af fladhængsel .....	82
4.2.1 Fjernelse af fladhængsel .....	82
4.2.2 Montering af fladhængsel .....	84
4.3 Udskiftning af glidehængsel .....	85
4.3.1 Fjernelse af glidehængsel.....	85
4.3.2 Montering af glidehængsel.....	86
4.4 Udskiftning af dørhylde .....	87
4.4.1 Fjernelse af dørhylde.....	87
4.4.2 Montering af dørhylde .....	87
4.5 Udskiftning af hylde .....	88
4.5.1 Fjernelse af hylde.....	88
4.5.2 Montering af hylde .....	88
4.6 Udskiftning af udtrækkelig hylde .....	89
4.6.1 Fjernelse af udtrækkelig hylde .....	89
4.6.2 Montering af udtrækkelig hylde .....	89
4.7 Udskiftning af hylde i fryseafdeling.....	90
4.7.1 Fjernelse af hylde i fryseafdeling .....	90
4.7.2 Montering af hylde i fryseafdeling.....	90

4.8 Udskiftning af frostvarebeholder.....	91
4.8.1 Fjernelse af frostvarebeholder .....	91
4.8.2 Montering af frostvarebeholder .....	91
4.9 Udskiftning af frugt- og grøntsagsbeholder .....	92
4.9.1 Fjernelse af frugt- og grøntsagsbeholder.....	92
4.9.2 Montering af frugt- og grøntsagsbeholder.....	92
4.10 Udskiftning af frugt- og grøntsagsbeholderens rumadskillelse og afdækning.....	93
4.10.1 Fjernelse af frugt- og grøntsagsbeholderens rumadskillelse og afdækning.....	93
4.10.2 Montering af frugt- og grøntsagsbeholderens rumadskillelse og afdækning.....	93
4.11 Udskiftning af kold-og-frisk-beholder .....	94
4.11.1 Fjernelse af kold-og-frisk-beholder .....	94
4.11.2 Montering af kold-og-frisk-beholder.....	94
4.12 Udskiftning af udtrækkelig beholder .....	95
4.12.1 Fjernelse af udtrækkelig beholder .....	95
4.12.2 Montering af udtrækkelig beholder .....	95
4.13 Udskiftning af LED-spotlampe.....	96
4.13.1 Fjernelse af LED-spotlampe .....	96
4.13.2 Montering af LED-spotlampe .....	97

# **i** Om dette dokument

## 1.1 Vigtig information

### 1.1.1 Formål

Disse reparationsanvisninger hjælper kunden til selv at kunne reparere apparater i henhold til den gældende lovgivning om miljøvenligt design (fra 03/2021).





De indeholder information om, hvordan der udskiftes bestemte reservedele, herunder advarsler og risici.

Kontakt kundeservice i tilfælde af spørgsmål. Vi påtager os kun ansvar for skader, hvis reparationsanvisningerne er fuldt korrekt.

## 1.2 Forklaring af symboler

### 1.2.1 Fareniveauer

Advarselsniveauerne består af et symbol og et signalford. Signalfordene indikerer farens alvor.





Advarselsniveau	Betydning
	Manglende overholdelse af advarselsmeddelelsen vil medføre død eller alvorlige kvæstelser.
	Manglende overholdelse af advarselsmeddelelsen kan medføre død eller alvorlige kvæstelser.
	Manglende overholdelse af advarselsmeddelelsen kan medføre mindre kvæstelser.
	Manglende overholdelse af advarselsmeddelelsen kan medføre materiel beskadigelse.

Tabel 1: Fareniveauer





### 1.2.2 Faresymboler

Faresymboler er symbolske visninger, der giver en indikation af faretypen.

Der anvendes følgende faresymboler i dette dokument:

Faresymbol	Betydning
	Generel advarselsmeddelelse
	Fare for elektrisk spænding
	Eksplussionsfare
	Fare for at skære sig

## i Om dette dokument

Faresymbol	Betydning
	Fare for klemning
	Fare pga. varme overflader
	Fare pga. kraftigt magnetfelt
	Fare pga. ikke-ioniserende stråling

Tabel 2: Faresymboler

### 1.2.3 Advarslernes opbygning

Advarsler i dette dokument har et standardiseret udseende og en standardiseret opbygning.

	<p><b>FARE</b></p> <p><b>Farens type og kilde!</b>            Mulige følger, hvis faren/advarslen ignoreres.</p> <ul style="list-style-type: none"> <li>▶ Foranstaltninger og forbud for at forhindre faren.</li> </ul>
--	---

De følgende eksempler viser en advarsel, der advarer mod elektrisk stød pga. spændingsførende dele. Foranstaltningen til at undgå faren er nævnt.

	<p><b>FARE</b></p> <p><b>Fare for elektrisk stød pga. spændingsførende dele!</b>            Død ved elektrisk stød</p> <ul style="list-style-type: none"> <li>▶ Afbryd apparater fra strømforsyningen i mindst 60 sekunder, før reparationer påbegyndes.</li> </ul>
--	---

### 1.2.4 Generelle symboler

Der anvendes følgende generelle symboler i dette dokument:

Generelt symbol	Betydning
	Angivelse af et særligt tip (tekst og/eller grafik)
	Angivelse af et simpelt tip (kun tekst)
	Angivelse af et link til en videotutorial
	Angivelse af nødvendige værktøjer
	Angivelse af krævede forudsætninger
	Angivelse af en betingelse (hvis..., så...)
	Angivelse af et resultat
	Angivelse af en tast eller knap
	Angivelse af et materialenummer
	Angivelse af en vist tekst/et vist vindue (i apparatets display)

Tabel 3: Generelle symboler

## 2.1 Generelle sikkerhedsanvisninger

### 2.1.1 Alle husholdningsapparater

#### **Fare for elektrisk stød pga. spændingsførende dele!**

- Fejl i forbindelse med reparationer, der involverer elektriske komponenter, kan medføre elektrisk stød!
- Afbryd apparatet fra strømnettet i mindst 60 sekunder, før arbejdet påbegyndes.
- Få efter reparationen udført en sikkerhedstest i henhold til VDE 0701 eller landespecifikke forskrifter.

#### **Fare for tilskadekomst pga. skarpe kanter!**

- Brug beskyttelseshandsker.

#### **Fare for klemning i forbindelse med reparation, vedligeholdelse, fejlafhjælpning og service på grund af tunge og bevægelige komponenter**

- Brug sikkerhedssko.
- Sørg for at sikre tunge komponenter mod at falde ned.
- Stik kropsdele ind i bevægelige komponenter.



#### **Fare for apparatets sikkerhed/funktion!**

- Brug kun originale reservedele.

#### **Fare for beskadigelse af elektrostatisk følsomme komponenter (elektrostatiske afladninger)!**

- Berør ikke modulerne, herunder forbindelser og ledningsbaner.

## Værktøjer og hjælpemidler

Betegnelse	Detaljer	Billeder
Beskyttelsesklud [00342013]	60 cm x 50 cm	
Torx-bit TX20 [00340865]	6,3 mm (1/4")	
Specialværktøj [00342180]		

## 4.1 Udskiftning af dørpakning

### Preindstilling:

- ✔ Døren er åben.

### 4.1.1 Fjernelse af dørpakning

1. Frigør dørpakningen fra rillen i højre og venstre hjørne.

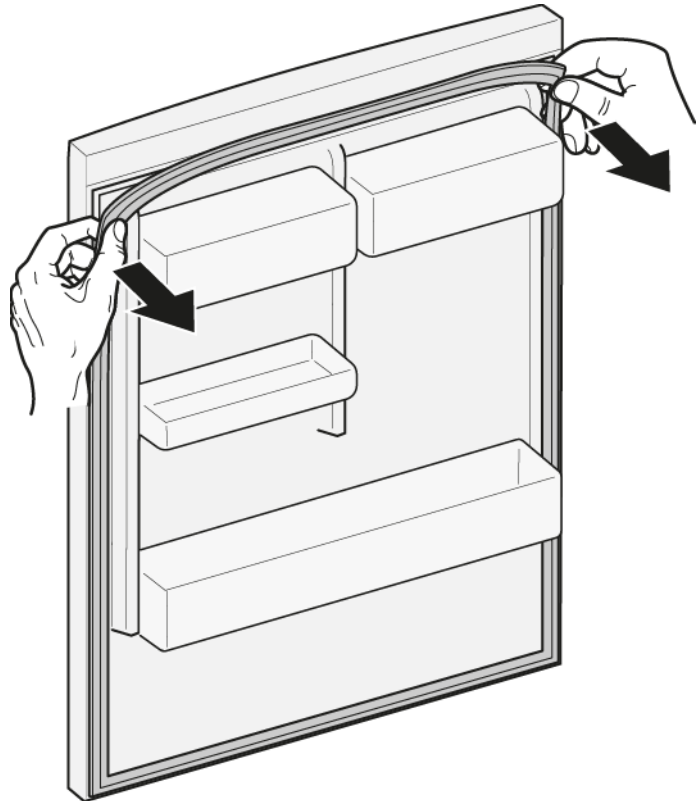

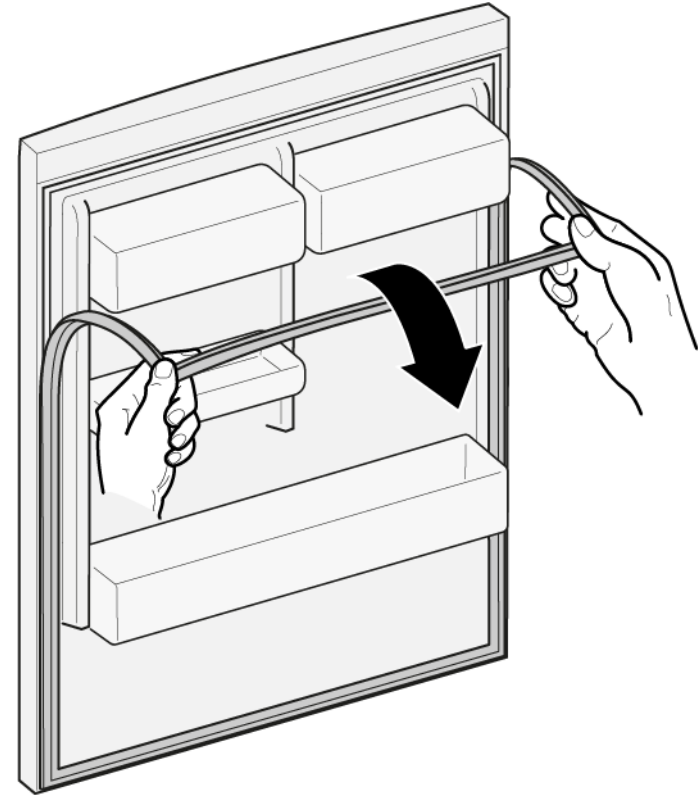

2. Træk dørpakningen ud af rillen.



- ➡ Dørpakningen er fjernet.

### 4.1.2 Montering af dørpakning

	Tykkelsen af den nye dørpakning kan afvige en smule fra tykkelsen af den gamle dørpakning. Dette vil ikke påvirke lukkemåden og den langsigtede funktion.
	Hvis apparatet har justerbare hængsler eller hængselbeslag, kan lukkemåden efterfølgende optimeres.
	Små sidehuller i dørpakningen er funktionelle (nødvendige til lufttilførelse). De er ikke produktionsfejl.

## Reparation

1. Kontrollér rillen til pakningen med hensyn til beskadigelse.

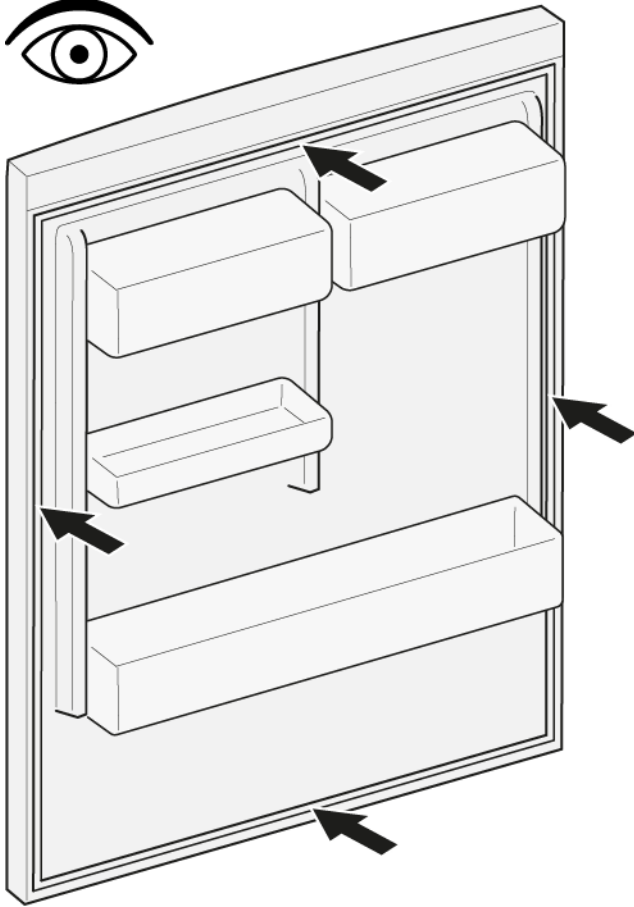

4. Tryk pakningens hjørner i rillen foroven og forneden.

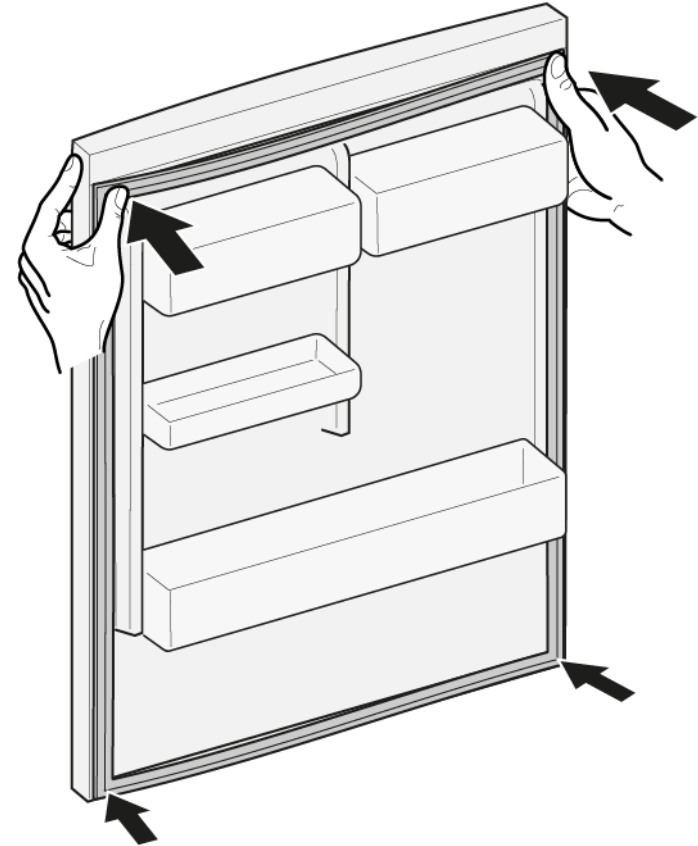

2.  Hvis rillen til pakningen er beskadiget:
  - Kontakt kundeservice.

3.  En smule deformation på dørpakningen er normalt og påvirker ikke dens funktion. Det anbefales til at glatte dørpakningen, før den sættes i apparatet.

Opvarm dørpakningen med en hårtørrer eller varmt vand, og genform den manuelt.



## Reparation

5. Tryk hele pakningen trinvist i rillen.

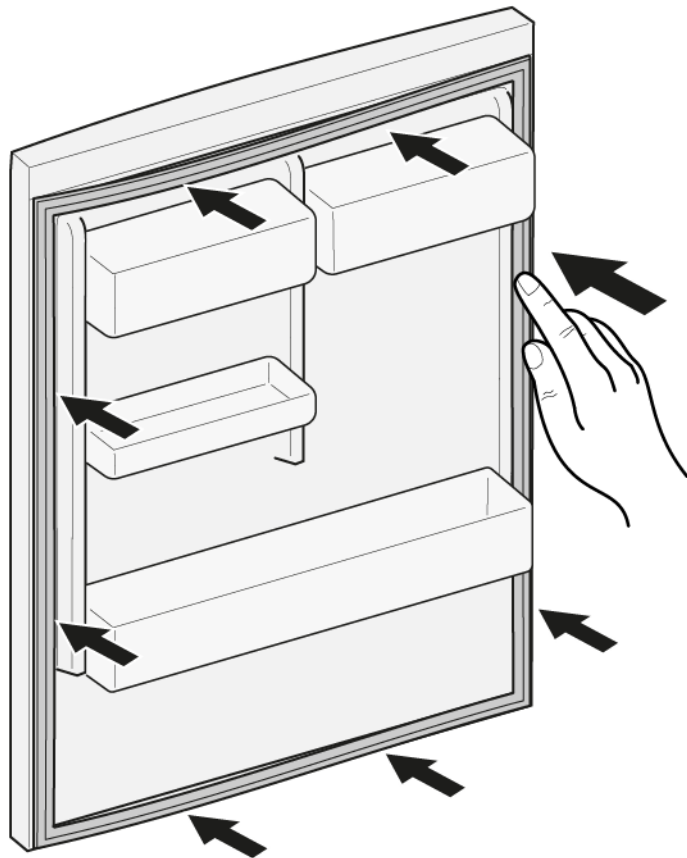

 Dørpakningen er monteret.

## 4.2 Udskiftning af fladhængsel

### Nødvendig værktøj:

🌀 Torx-bit TX20

6,3 mm (1/4")

[00340865]

	<b>⚠ ADVARSEL</b>
	<p><b>Tunge, store apparater!</b> Ryg- og muskelskader</p> <ul style="list-style-type: none"> <li>▶ Arbejde til fjernelse af apparatets dør bør kun udføres af uddannede specialister.</li> <li>▶ Der skal være to personer om at flytte apparatet.</li> <li>▶ Brug kun egnet værktøj og udstyr.</li> </ul>

	<b>⚠ PAS PÅ!</b>
	<p><b>Skarpe kanter!</b> Snitlæsioner</p> <ul style="list-style-type: none"> <li>▶ Brug beskyttelseshandsker.</li> </ul>

	<b>⚠ PAS PÅ!</b>
	<p><b>Åbent hængselområde!</b> Fingre kan blive klemt/sætte sig fast</p> <ul style="list-style-type: none"> <li>▶ Grib ikke ind i hængselområdet.</li> <li>▶ Brug beskyttelseshandsker.</li> </ul>

	<b>⚠ PAS PÅ!</b>
	<p><b>Fare for nedfaldende dele pga. løsnede skruer!</b> Personskade pga. nedfaldende dele.</p> <ul style="list-style-type: none"> <li>▶ Sørg for at sikre komponenten mod at falde ned.</li> </ul>

	<b>BEMÆRK!</b>
	<p><b>Fare for nedfaldende dele pga. løsnede skruer!</b> Beskadigelse af andre apparatdele eller kundens hjem, f.eks. gulvet.</p> <ul style="list-style-type: none"> <li>▶ Sørg for at sikre komponenten mod at falde ned.</li> </ul>

### Preindstilling:

- ✅ Apparatet er afbrudt fra strømforsyningen.
- ✅ Møbeldøren er fjernet. Se monteringsanvisningen.
- ✅ Døren er åben.

## 4.2.1 Fjernelse af fladhængsel

Sørg for, at hængslerne ikke lukker, når de fjernes/monteres.

1. Fjern de fire hængsels afdækninger.

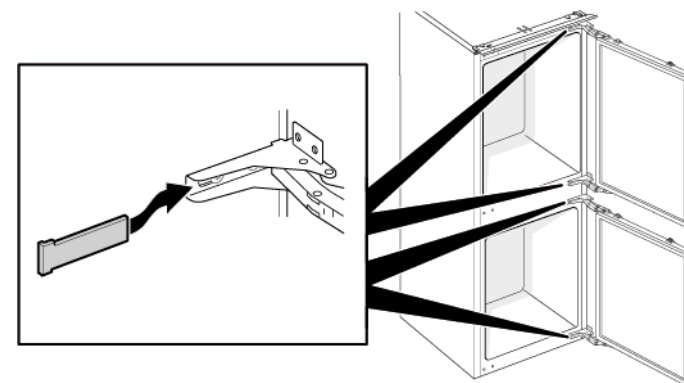

## Reparation

2. 1. Løsn de fire skruer (1).  
2. Glid den øverste dør ud, og fjern den (2).

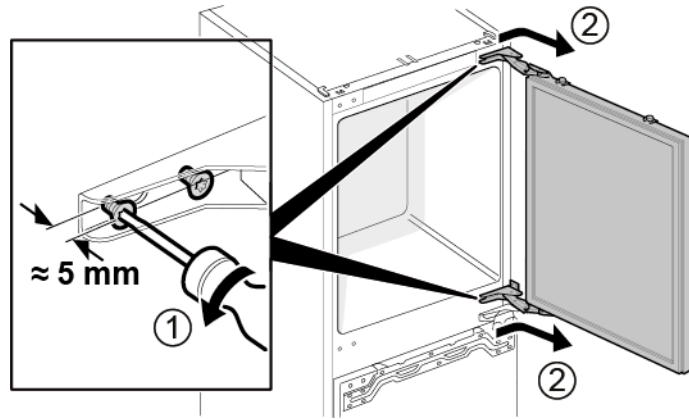

3. 1. Fjern de fire skruer (1).  
2. Fjern hængslerne (2).

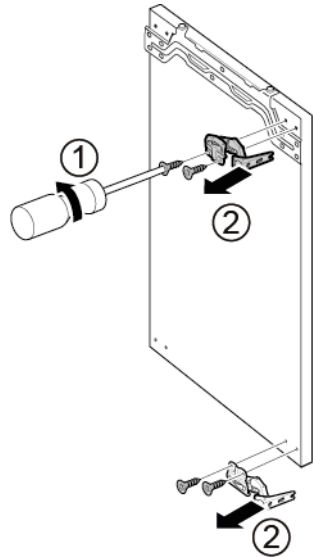

 De øverste dørhængsler er fjernet.

4. 1. Løsn de fire skruer (1).  
2. Glid den nederste dør ud, og fjern den (2).

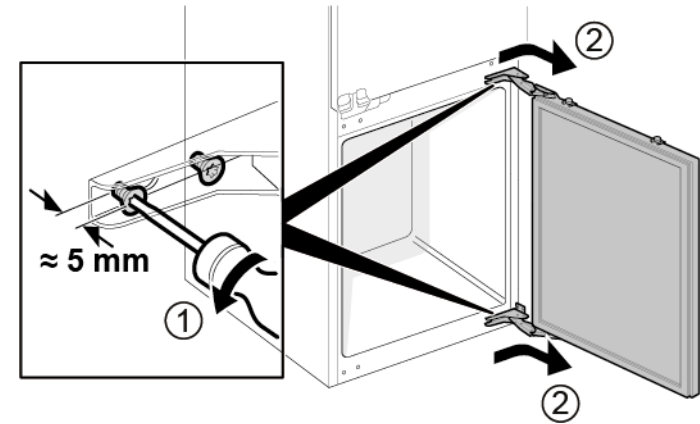

5. 1. Fjern de fire skruer (1).  
2. Fjern hængslerne (2).

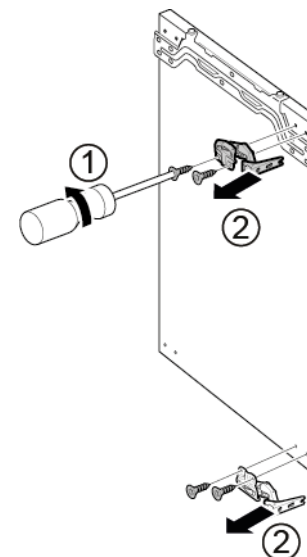

 De nederste dørhængsler er fjernet.

## **4.2.2 Montering af fladhængsel**

- ▶ Montér i omvendt rækkefølge.

## 4.3 Udskiftning af glidehængsel

### Nødvendig værktøj:

🌀 Torx-bit TX20

6,3 mm (1/4")

[00340865]



#### ⚠️ ADVARSEL

##### Tunge, store apparater!

Ryg- og muskelskader

- ▶ Arbejde til fjernelse af apparatets dør bør kun udføres af uddannede specialister.
- ▶ Der skal være to personer om at flytte apparatet.
- ▶ Brug kun egnet værktøj og udstyr.



#### ⚠️ PAS PÅ!

##### Skarpe kanter!

Snitlæsioner

- ▶ Brug beskyttelseshandsker.



#### ⚠️ PAS PÅ!

##### Fare for nedfaldende dele pga. løsnede skruer!

Personskade pga. nedfaldende dele.

- ▶ Sørg for at sikre komponenten mod at falde ned.



#### BEMÆRK!

##### Fare for nedfaldende dele pga. løsnede skruer!

Beskadigelse af andre apparatdele eller kundens hjem, f.eks. gulvet.

- ▶ Sørg for at sikre komponenten mod at falde ned.

### Preindstilling:

- ✔️ Apparatet er afbrudt fra strømforsyningen.
- ✔️ Møbeldøren og apparatets dør er adskilt. Se monteringsanvisningen.

## 4.3.1 Fjernelse af glidehængsel

1. Skru de to skruer ud (1).
2. Fjern den øverste dørs øverste hængsel (2).
3. Fjern den øverste dør (3).
4. Skru de to skruer ud (4).
5. Fjern den nederste dørs øverste hængsel (5).
6. Fjern den nederste dør (6).

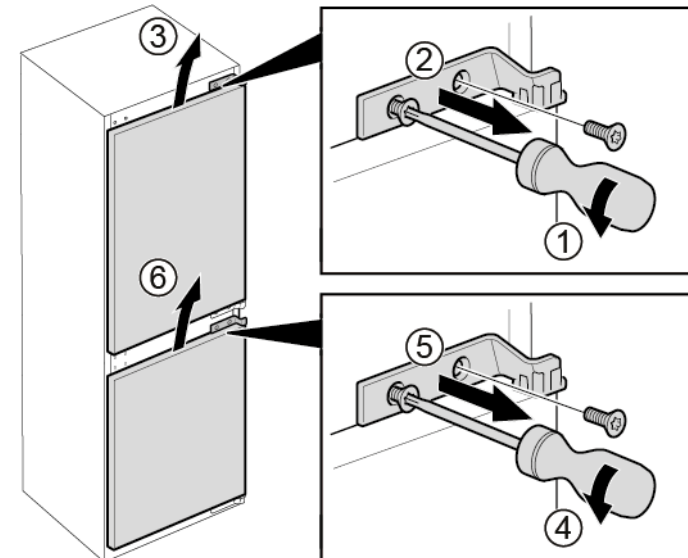

## Reparation

2. 1. Fjern de fire skruer (1).
2. Fjern de nederste hængsler (2).

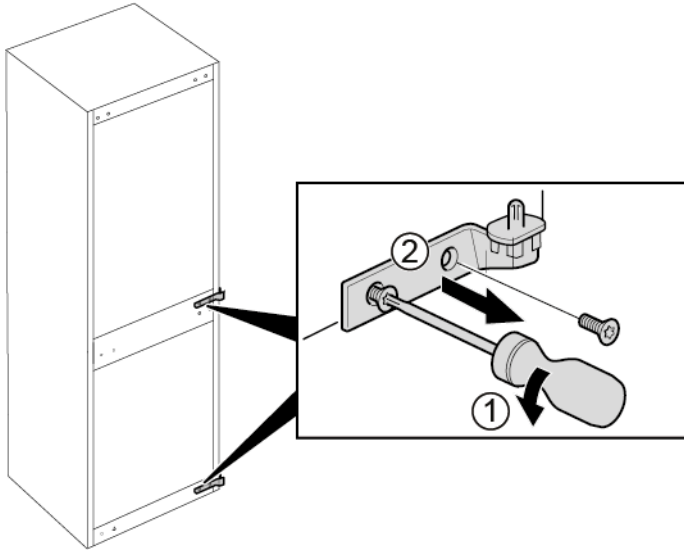

 Hængslerne er fjernet.

### 4.3.2 Montering af glidehængsel

- ▶ Montér i omvendt rækkefølge.

## 4.4 Udskiftning af dørhylde

### Preindstilling:

- ✔ Døren er åben.

### 4.4.1 Fjernelse af dørhylde

- ▶ Løft dørhylden opad.

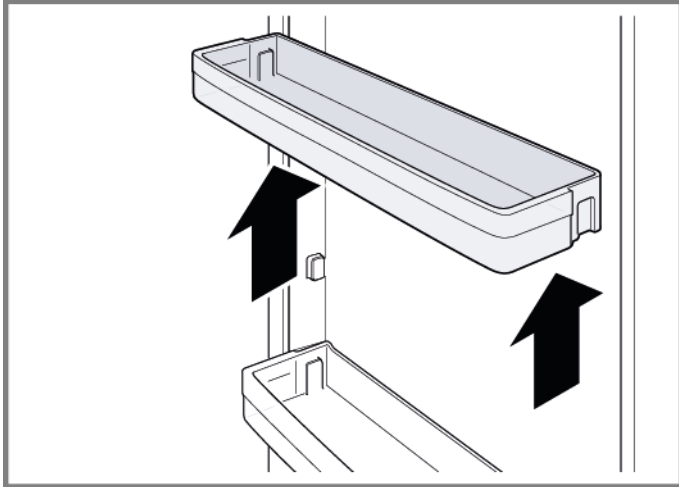

- ➡ Dørhylden er fjernet.

### 4.4.2 Montering af dørhylde

- ▶ Montér i omvendt rækkefølge.

## 4.5 Udskiftning af hylde

### Preindstilling:

- ✔ Døren er åben.

### 4.5.1 Fjernelse af hylde

- ▶ Træk hyliden ud.

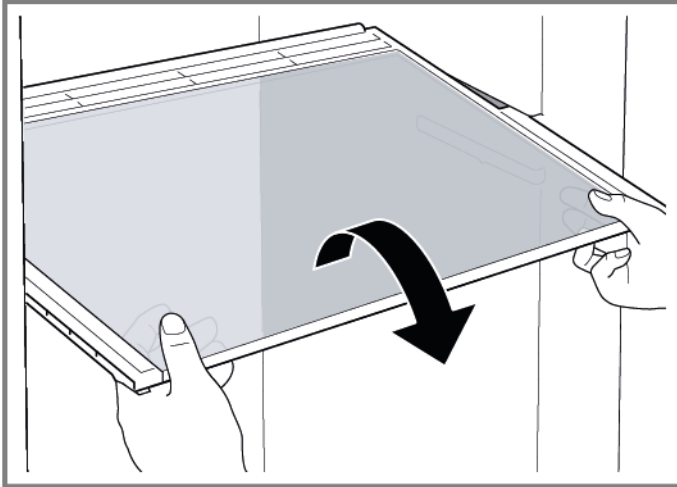

- ➡ Hyliden er fjernet.

### 4.5.2 Montering af hylde

- ▶ Montér i omvendt rækkefølge.



## 4.6 Udskiftning af udtrækkelig hylde

Preindstilling:

- ✔ Døren er åben.

### 4.6.1 Fjernelse af udtrækkelig hylde

1. Træk den udtrækkelige hylde ud, indtil låsehagen udløses.

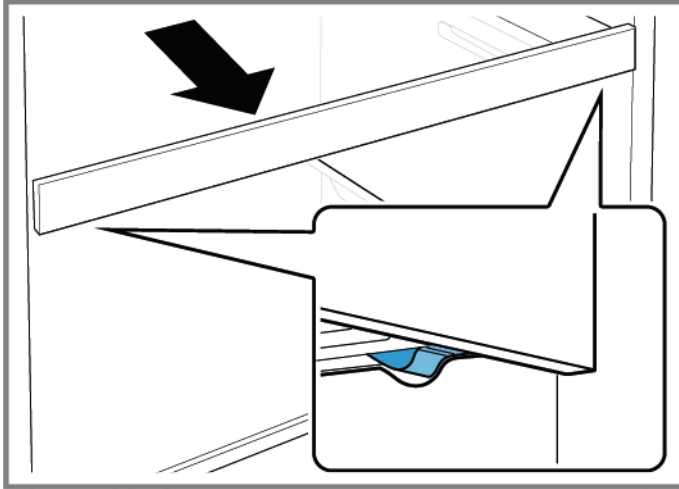

2. Sænk den udtrækkelige hylde, og drej den ud til siden.
3.  Den udtrækkelige hylde er fjernet.

### 4.6.2 Montering af udtrækkelig hylde

- ▶ Montér i omvendt rækkefølge.

## 4.7 Udskiftning af hylde i fryseafdeling

### Preindstilling:

- ✔ Døren er åben.

### 4.7.1 Fjernelse af hylde i fryseafdeling

- ▶ Træk hylden i fryseafdelingen ud.

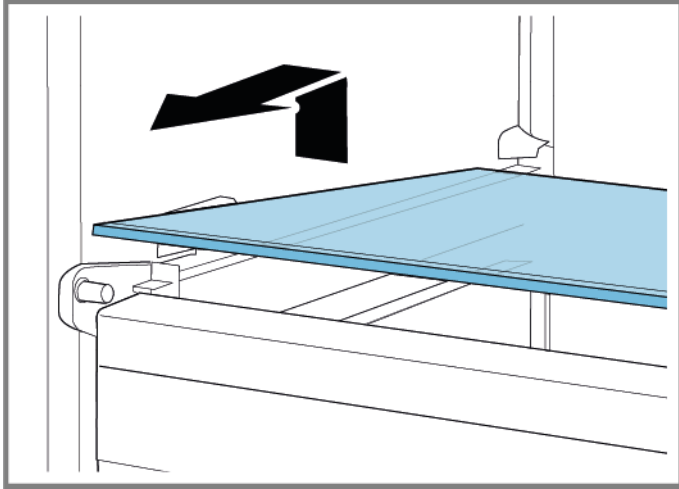

- ➡ Hylden i fryseafdelingen er fjernet.

### 4.7.2 Montering af hylde i fryseafdeling

- ▶ Montér i omvendt rækkefølge.

## 4.8 Udskiftning af frostvarebeholder

### Preindstilling:

- ✔ Døren er åben.

### 4.8.1 Fjernelse af frostvarebeholder

- ▶ 1. Træk frostvarebeholderen hele vejen ud (1).
- ▶ 2. Fjern frostvarebeholderen (2).

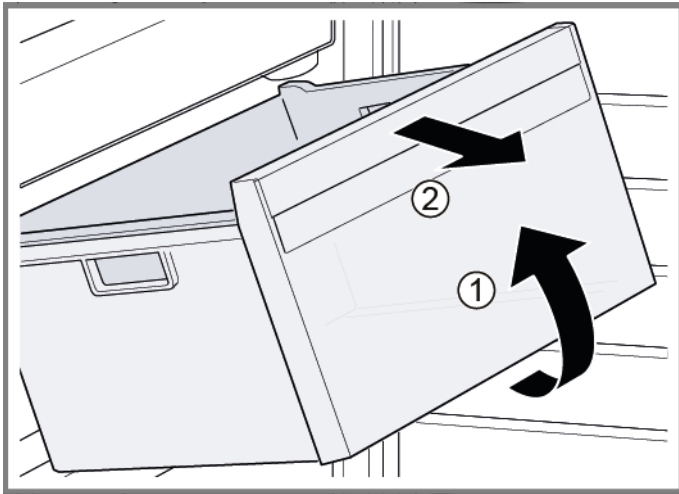

- ➡ Frostvarebeholderen er fjernet.

### 4.8.2 Montering af frostvarebeholder

- ▶ Montér i omvendt rækkefølge.

## 4.9 Udskiftning af frugt- og grøntsagsbeholder

### Preindstilling:

- ✔ Døren er åben.

### 4.9.1 Fjernelse af frugt- og grøntsagsbeholder

- ▶ 1. Træk beholderen hele vejen ud (1).
- ▶ 2. Fjern beholderen (2).

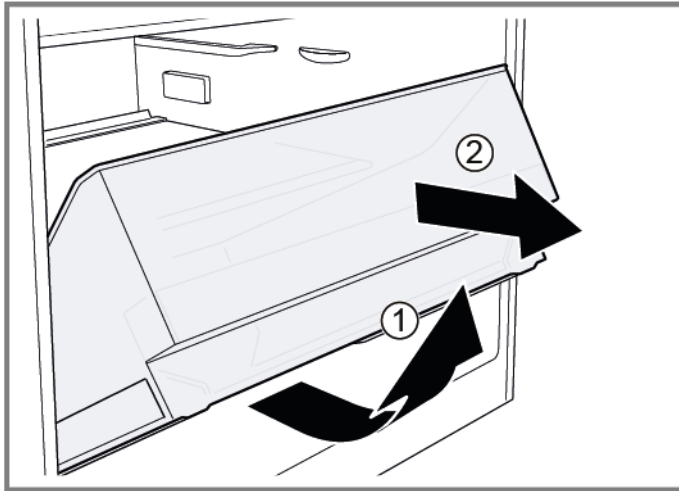

- ➡ Beholderen er fjernet.

### 4.9.2 Montering af frugt- og grøntsagsbeholder

- ▶ Montér i omvendt rækkefølge.

## 4.10 Udskiftning af frugt- og grøntsagsbeholderens rumadskillelse og afdækning

### Preindstilling:

- ✔ Døren er åben.

### 4.10.1 Fjernelse af frugt- og grøntsagsbeholderens rumadskillelse og afdækning

1. Fjern glaspladen fra rumadskillelsen.

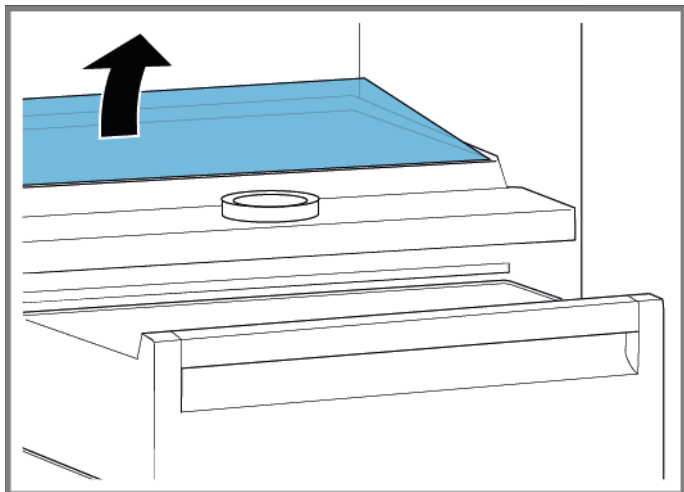

2. [Fjern frugt- og grøntsagsbeholderen. → 92](#)

3. 1. Tryk på grebet på undersiden i begge sider af rumadskillelsen (1).  
2. Træk rumadskillelsen fremad (2).

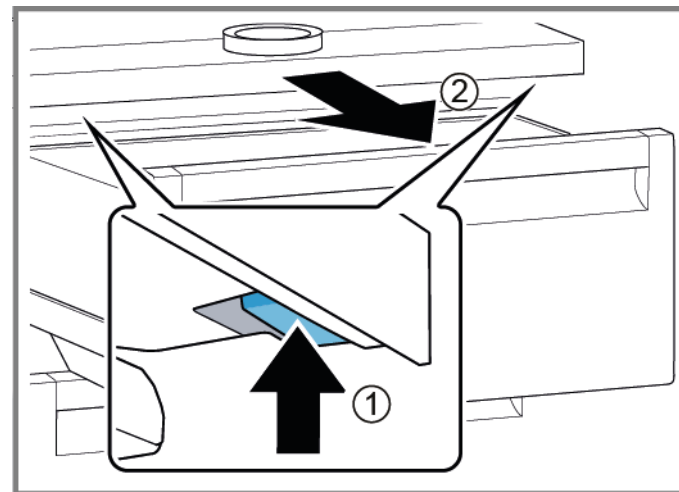

4. Løft rumadskillelsen, og drej den ud til siden.  
➡ Rumadskillelsen er fjernet.
5. 1. Løft frugt- og grøntsagsbeholderens afdækning.  
2. Træk frugt- og grøntsagsbeholderens afdækning fremad, og drej den ud til siden.  
➡ Frugt- og grøntsagsbeholderens afdækning er fjernet.

### 4.10.2 Montering af frugt- og grøntsagsbeholderens rumadskillelse og afdækning

- ▶ Montér i omvendt rækkefølge.

## 4.11 Udskiftning af kold-og-frisk-beholder

### Preindstilling:

- ✔ Døren er åben.

### 4.11.1 Fjernelse af kold-og-frisk-beholder

- ▶ 1. Vip kold-og-frisk-beholderen fremad (1).
- ▶ 2. Fjern kold-og-frisk-beholderen (2).

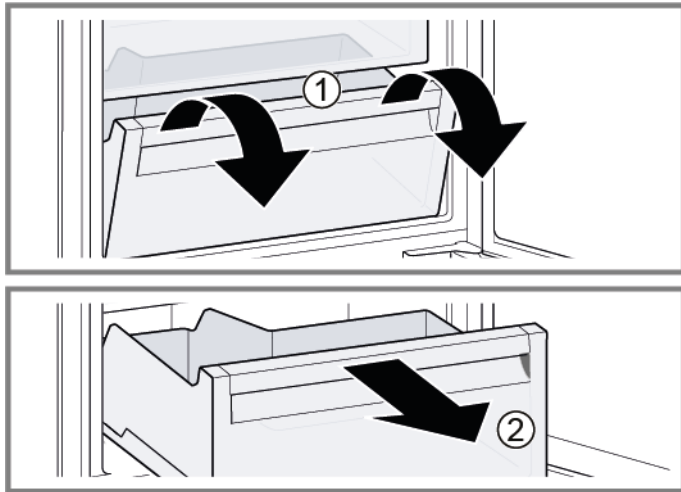

- ➡ Kold-og-frisk-beholderen er fjernet.

### 4.11.2 Montering af kold-og-frisk-beholder

- ▶ Montér i omvendt rækkefølge.

## 4.12 Udskiftning af udtrækkelig beholder

### Preindstilling:

- ✔ Døren er åben.

### 4.12.1 Fjernelse af udtrækkelig beholder

- ▶ 1. Vip den udtrækkelige beholder fremad (1).
- ▶ 2. Fjern den udtrækkelige beholder (2).

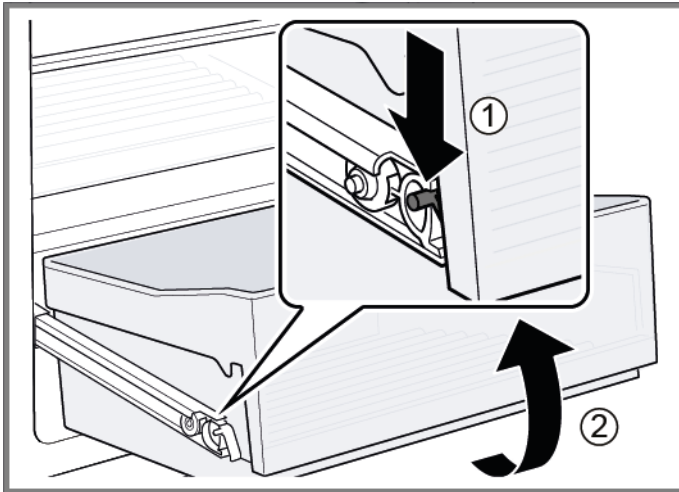

- ➡ Den udtrækkelige beholder er fjernet.

### 4.12.2 Montering af udtrækkelig beholder

- ▶ Montér i omvendt rækkefølge.

## 4.13 Udskiftning af LED-spotlampe

### Nødvendig værktøj:

- 🔧 Specialværktøj [00342180]
- 🔧 Kærviskruetrækker Blad 2,4 mm x 0,4 mm x 60 mm i sættet [00341820]

 Dit apparat er udstyret med en vedligeholdelsesfri LED-lampe. Denne lampe må kun repareres af kundeservice eller autoriserede teknikere!

 **FARE**  
**Fare for elektrisk stød pga. spændingsførende dele!**  
Livsfare pga. elektrisk stød i tilfælde af ukorrekt reparation

- ▶ Elektriske dele skal repareres af kvalificerede elektrikere.
- ▶ Få efter reparationen udført en sikkerhedstest i henhold til VDE 0701 eller landespecifikke forskrifter.

 **FARE**  
**Fare for elektrisk stød pga. spændingsførende dele!**  
Død ved elektrisk stød

- ▶ Afbryd apparater fra strømforsyningen i mindst 60 sekunder, før reparationer påbegyndes.

 **PAS PÅ!**  
**Skarpe kanter!**  
Snitlæsioner

- ▶ Brug beskyttelseshandsker.

### Preindstilling:

- ✅ Apparatet er afbrudt fra strømforsyningen.
- ✅ Døren er åben.
- ✅ Hyldeerne i køleafdelingen er fjernet.

### 4.13.1 Fjernelse af LED-spotlampe

1. Frigør LED-spotlampens afdækning.

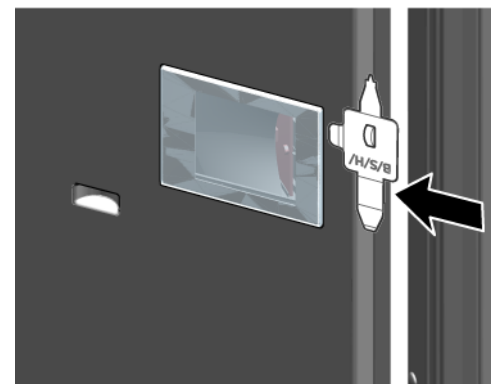

2. Træk LED-spotlampens afdækning indad, og skub den samtidigt fremad.

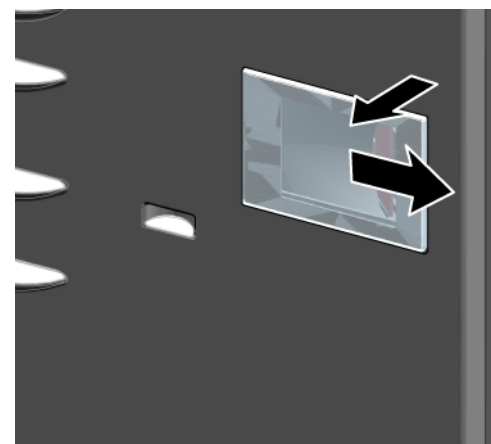



3. Frigør LED-spotlampemodulet.

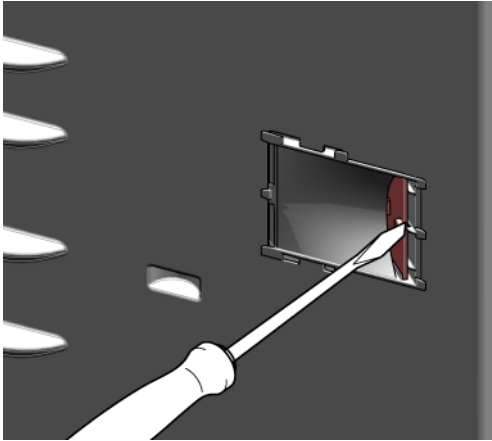

4. Afbryd LED-spotlampens elektriske tilslutning.

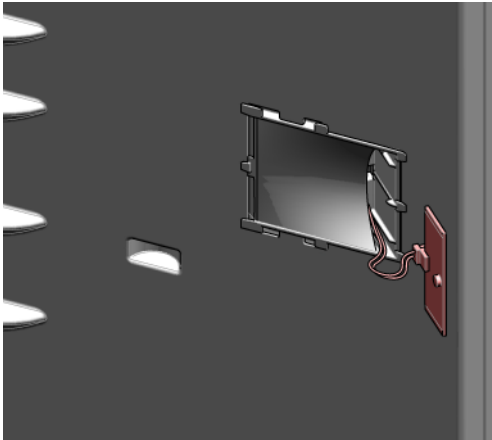





 LED-spotlampen er fjernet.

### 4.13.2 Montering af LED-spotlampe

- ▶ Montér i omvendt rækkefølge.

# Reparatie informatie - Koelvriescombinatie

 <b>Over dit document</b> .....	<b>99</b>
1.1 Belangrijke informatie .....	99
1.1.1 Doel .....	99
1.2 Verklaring van symbolen.....	99
1.2.1 Gevarenniveaus.....	99
1.2.2 Gevarensymbolen.....	99
1.2.3 Structuur van de waarschuwingen.....	100
1.2.4 Algemene symbolen.....	100
 <b>Veiligheid</b> .....	<b>101</b>
2.1 Algemene veiligheidsinstructies.....	101
2.1.1 Alle huishoudelijke apparaten .....	101
 <b>Gereedschappen en hulpmiddelen</b> .....	<b>102</b>
 <b>Reparatie</b> .....	<b>103</b>
4.1 Deurafdichting vervangen .....	103
4.1.1 Deurafdichting verwijderen .....	103
4.1.2 Deurafdichting monteren .....	103
4.2 Plat scharnier vervangen .....	106
4.2.1 Plat deurscharnier verwijderen.....	106
4.2.2 Plat scharnier monteren .....	108
4.3 Sleepscharnier vervangen.....	109
4.3.1 Sleepscharnier verwijderen.....	109
4.3.2 Sleepscharnier monteren.....	110
4.4 Deurrek vervangen .....	111
4.4.1 Deurrek verwijderen .....	111
4.4.2 Deurrek monteren .....	111
4.5 Plateau vervangen.....	112
4.5.1 Plateau verwijderen.....	112
4.5.2 Plateau monteren.....	112
4.6 Uittrekbaar plateau vervangen.....	113
4.6.1 Uittrekbaar plateau verwijderen.....	113
4.6.2 Het uittrekbare plateau installeren.....	113
4.7 Plateau van het vriesvak vervangen .....	114
4.7.1 Plateau van het vriesvak verwijderen .....	114
4.7.2 Plateau van het vriesvak installeren .....	114
4.8 Vrieslade vervangen .....	115
4.8.1 Vrieslade verwijderen .....	115
4.8.2 Vrieslade installeren .....	115
4.9 Groente- en fruitlade vervangen.....	116
4.9.1 Groente- en fruitlade verwijderen.....	116
4.9.2 Groente- en fruitlade installeren.....	116
4.10 Tussenschot en afdekplaat van de groente- en fruitlade vervangen .....	117
4.10.1 Tussenschot en afdekplaat van de groente- en fruitlade verwijderen... 117	
4.10.2 Tussenschot en afdekplaat van de groente- en fruitlade installeren .... 117	
4.11 Verskoellade vervangen .....	118
4.11.1 Verskoellade verwijderen .....	118
4.11.2 Verskoellade installeren .....	118
4.12 Uittrekbare lade vervangen.....	119
4.12.1 Uittrekbare lade verwijderen.....	119
4.12.2 Uittrekbare lade monteren.....	119
4.13 LED-verlichting vervangen.....	120
4.13.1 LED-verlichting verwijderen.....	120
4.13.2 LED-verlichting installeren.....	121

# **i** Over dit document

## 1.1 Belangrijke informatie

### 1.1.1 Doel

Met deze reparatieaanwijzingen wordt de klant geholpen zelf apparaten te repareren conform de toepasselijke verordening inzake ecologisch ontwerp (met ingang van 03/2021).





Ze bevatten informatie over hoe gedefinieerde reserveonderdelen kunnen worden vervangen met inbegrip van waarschuwingen en gevaren.

Neem bij vragen contact op met onze klantenservice. We stellen ons alleen aansprakelijk voor schade als de reparatieaanwijzingen correct zijn opgevolgd.

## 1.2 Verklaring van symbolen

### 1.2.1 Gevarenniveaus

De waarschuwningsniveaus worden aangegeven met een symbool en een signaalwoord. Het signaalwoord geeft de ernst van het gevaar aan.





Waarschuwningsniveau	Betekenis
	Als de waarschuwing niet in acht wordt genomen, leidt dat tot ernstig of dodelijk letsel.
	Als de waarschuwing niet in acht wordt genomen, kan dat tot ernstig of dodelijk letsel leiden.
	Als de waarschuwing niet in acht wordt genomen, kan dat tot licht letsel leiden.
	Als de waarschuwing niet in acht wordt genomen, kan dat tot materiële schade leiden.

Tabel 1: Gevarenniveaus

### 1.2.2 Gevarensymbolen

Gevarensymbolen zijn symbolische afbeeldingen die een indicatie geven van het soort gevaar.

De volgende gevarensymbolen worden in dit document gebruikt:

Gevarensymbool	Betekenis
	Algemene waarschuwing
	Gevaar voor elektrische spanning
	Ontploffingsgevaar
	Snijgevaar

## **i** Over dit document

Gevarensymbool	Betekenis
	Beknellingsgevaar
	Gevaar voor hete oppervlakken
	Gevaar voor sterke magnetische velden
	Gevaar voor niet-ioniserende straling

Tabel 2: Gevarensymbolen

### 1.2.3 Structuur van de waarschuwingen

Waarschuwingen in dit document hebben een gestandaardiseerd uiterlijk en een gestandaardiseerde structuur.







	<div style="background-color: red; color: white; padding: 2px; text-align: center;"><b>⚠ GEVAAR</b></div> <p><b>Soort gevaar en bron van het gevaar!</b> Mogelijke gevolgen van het negeren van het gevaar / de waarschuwing.</p> <ul style="list-style-type: none"> <li>▶ Maatregelen en verboden om het gevaar te voorkomen.</li> </ul>
--	---

In het volgende voorbeeld is een waarschuwing te zien waarmee voor een elektrische schok aan stroomvoerende onderdelen wordt gewaarschuwd. De maatregel om het gevaar te vermijden wordt vermeld.

	<div style="background-color: red; color: white; padding: 2px; text-align: center;"><b>⚠ GEVAAR</b></div> <p><b>Gevaar voor een elektrische schok aan stroomvoerende onderdelen!</b> Dood door elektrocutie</p> <ul style="list-style-type: none"> <li>▶ Haal apparaten minstens 60 seconden voor u met reparaties begint van de stroomvoorziening af.</li> </ul>
--	---

### 1.2.4 Algemene symbolen

De volgende algemene symbolen worden in dit document gebruikt:

Alg. symbool	Betekenis
	Identificatie van een speciale tip (tekst en/of afbeelding)
	Identificatie van een eenvoudige tip (tekst)
	Identificatie van een link naar een video-instructie
	Identificatie van vereiste gereedschappen
	Identificatie van vereiste voorwaarden
	Identificatie van een voorwaarde (als ..., dan ...)
	Identificatie van een resultaat
[Start]	Identificatie van een toets of knop
[00123456]	Identificatie van een materiaalnummer
Status	Identificatie van weergegeven tekst / venster (in het display van het apparaat)

Tabel 3: Algemene symbolen

## 2.1 Algemene veiligheidsinstructies

### 2.1.1 Alle huishoudelijke apparaten

#### **Gevaar voor een elektrische schok aan stroomvoerende onderdelen!**

- Fouten bij reparaties aan elektrische componenten kunnen tot een elektrische schok leiden!
- Koppel het apparaat minstens 60 seconden los van het stroomnet voordat u met de werkzaamheden begint.
- Laat na de reparatie een veiligheidstest conform VDE 0701 of de landspecifieke regelgeving uitvoeren.

#### **Gevaar voor letsel aan scherpe randen!**

- Draag veiligheidshandschoenen.

#### **Beknellingsgevaar tijdens reparatie, onderhoud, probleemoplossing en service vanwege zware en bewegende componenten**

- Draag veiligheidsschoenen.
- Beveilig zware componenten tegen vallen.
- Steek geen lichaamsdelen in bewegende componenten.



#### **Gevaar voor de veiligheid / werking van het apparaat!**

- Gebruik uitsluitend originele reserveonderdelen.

#### **Gevaar voor schade aan elektrostatisch gevoelige componenten (ESD's)!**

- Raak de modules met inbegrip van de aansluitingen en geleiderbanen niet aan.

## Gereedschappen en hulpmiddelen

Benaming	Details	Afbeeldingen
Beschermdoek [00342013]	60 cm x 50 cm	
Torxbit TX20 [00340865]	6,3 mm (1/4")	
Speciaal gereed- schap [00342180]		

## 4.1 Deurafdichting vervangen

Voorwaarde:

- ✔ Deur is open.

### 4.1.1 Deurafdichting verwijderen

1. Haal deurafdichting los uit de sleuf in de rechter- en linkerhoek.

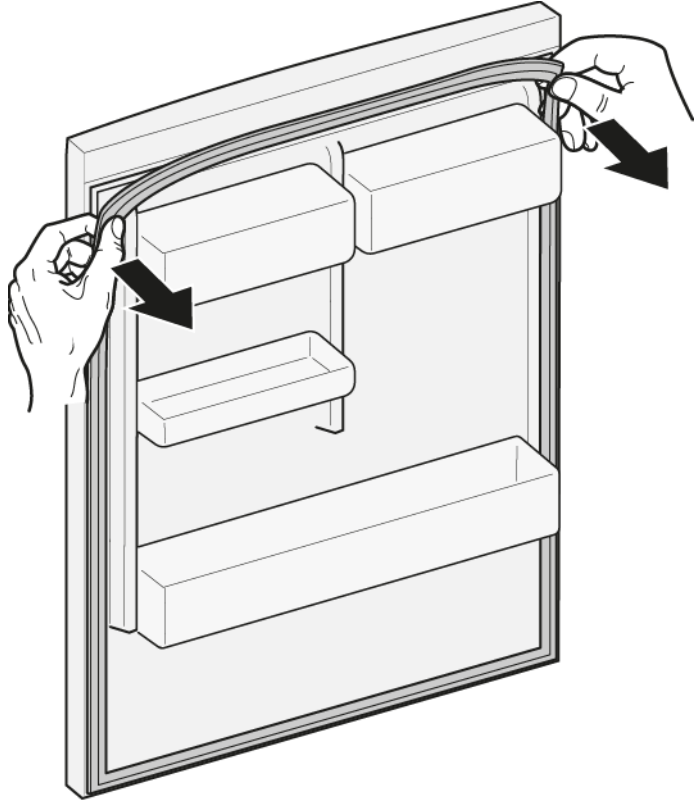

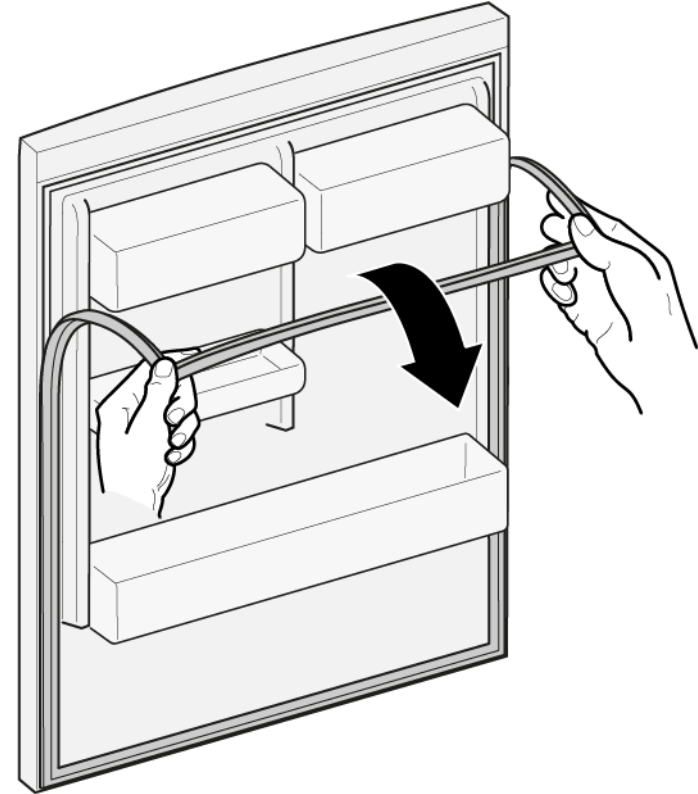

2. Trek deurafdichting uit gleuf.



- ➡ Deurafdichting wordt verwijderd.

### 4.1.2 Deurafdichting monteren

	De dikte van de nieuwe deurafdichting kan licht afwijken van de dikte van de oude deurafdichting. Dit doet geen afbreuk aan de sluiteigenschappen en de werking op de lange termijn.
	Als uw apparaat verstelbare scharnieren of scharnierbevestigingen heeft, kunt u de sluiteigenschappen later optimaliseren.
	De zijgaatjes in de deurafdichting zijn functioneel (vereist voor ventilatie). Dit zijn geen productiefouten.

## Reparatie

1. Controleer de sleuf voor de afdichting op schade.

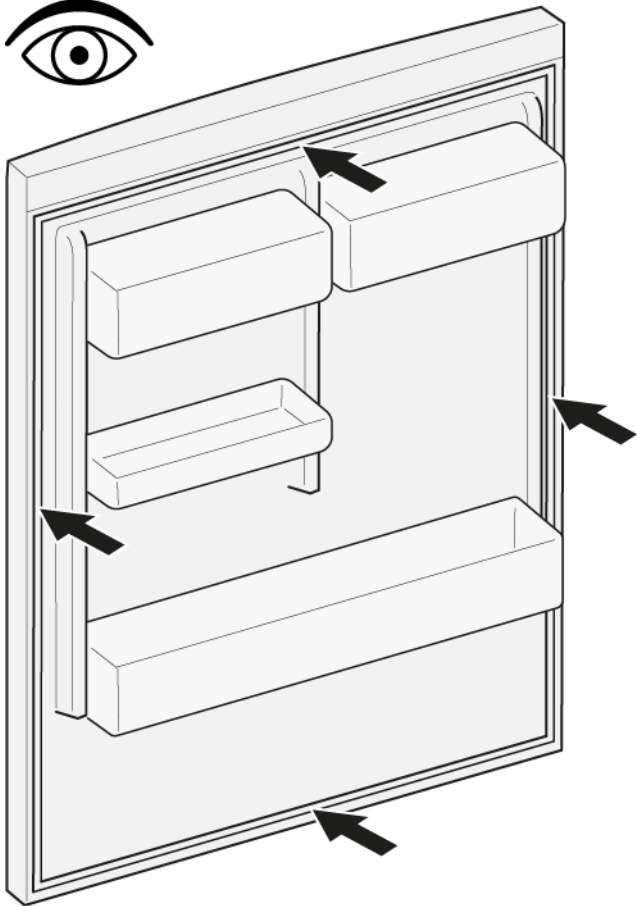

4. Duw de hoeken van de afdichting bovenaan en onderaan in de sleuf.

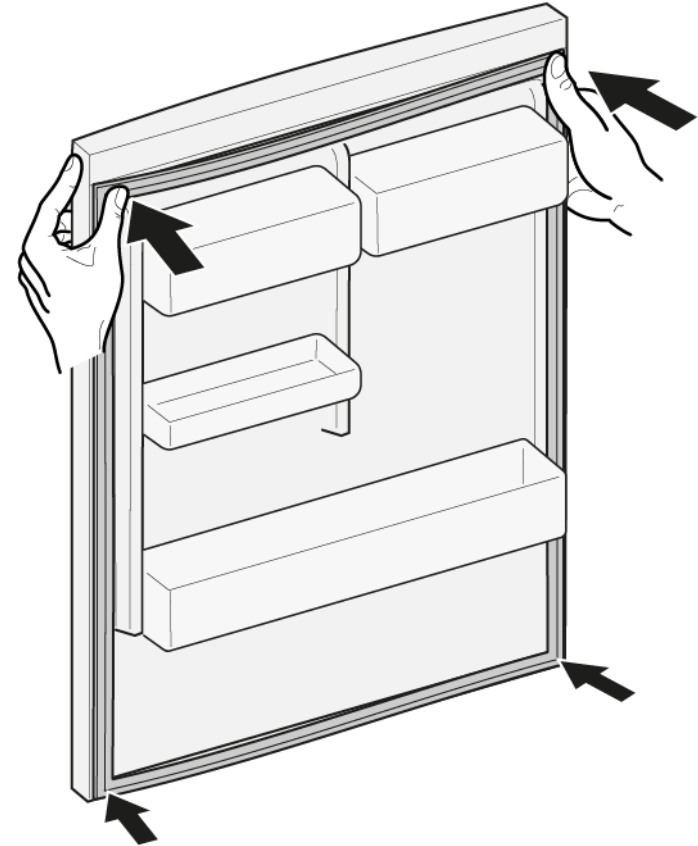

2.  Als de sleuf voor de afdichting is beschadigd:
  - Neem contact op met de klantenservice.

3.  Een lichte vervorming van de deurafdichting is normaal en doet geen afbreuk aan de werking. Geadviseerd wordt de deurafdichting recht te trekken voordat u deze in het apparaat steekt.

Verwarm de deurafdichting met een haardroger of met warm water en breng het handmatig terug in zijn vorm.



## Reparatie

5. Druk de hele afdichting stap voor stap in de sleuf.

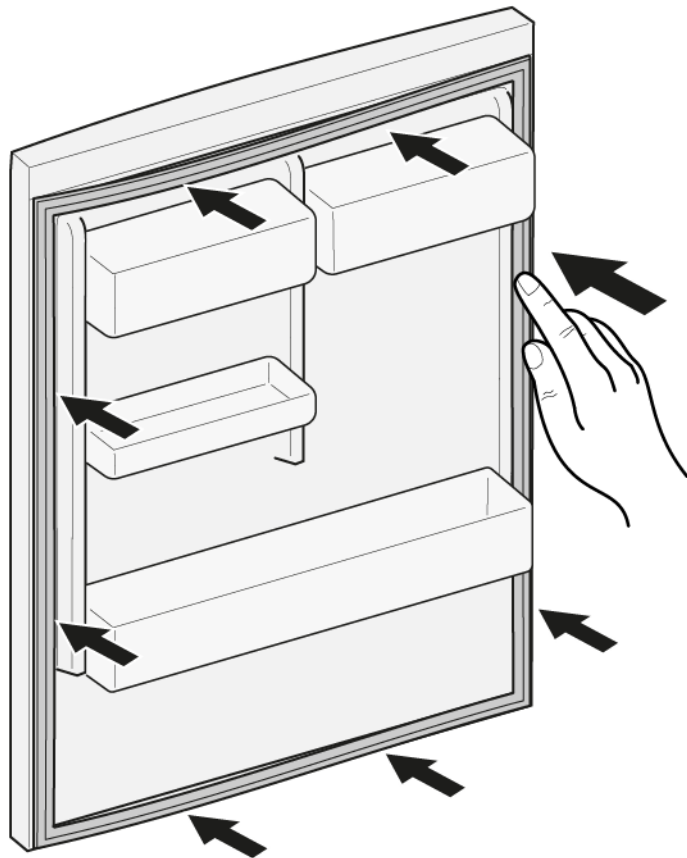

 De deurafdichting wordt gemonteerd.

## 4.2 Plat scharnier vervangen

### Speciale hulpmiddelen:

Torxbit TX20

6,3 mm (1/4")

[00340865]

	<p><b>WAARSCHUWING</b></p> <p><b>Zware, omvangrijke apparaten!</b> Rug- en spierletsel</p> <ul style="list-style-type: none"> <li>▶ De werkzaamheid van het verwijderen van de apparaatdeur mag alleen worden uitgevoerd door speciaal opgeleid personeel.</li> <li>▶ Om het apparaat te verplaatsen zijn twee mensen nodig.</li> <li>▶ Gebruik alleen geschikte gereedschappen en apparatuur.</li> </ul>
	<p><b>VOORZICHTIG</b></p> <p><b>Scherpe randen!</b> Snijletsel</p> <ul style="list-style-type: none"> <li>▶ Draag veiligheidshandschoenen.</li> </ul>
	<p><b>VOORZICHTIG</b></p> <p><b>Maak het scharniergedeelte open!</b> Beknelling/afklemming van vingers</p> <ul style="list-style-type: none"> <li>▶ Steek uw vingers niet in het scharniergedeelte.</li> <li>▶ Draag veiligheidshandschoenen.</li> </ul>
	<p><b>VOORZICHTIG</b></p> <p><b>Gevaar voor vallende onderdelen als gevolg van losgeraakte schroeven!</b> Letsel als gevolg van vallende onderdelen.</p> <ul style="list-style-type: none"> <li>▶ Beveilig component tegen vallen.</li> </ul>
	<p><b>LET OP!</b></p> <p><b>Gevaar voor vallende onderdelen als gevolg van losgeraakte schroeven!</b> Schade aan andere onderdelen van het apparaat of bij de klant thuis bijvoorbeeld aan de vloer.</p> <ul style="list-style-type: none"> <li>▶ Beveilig component tegen vallen.</li> </ul>

### Voorwaarde:

- ✓ Apparaat is losgekoppeld is van de stroomvoorziening.

- ✓ Meubeldeur wordt verwijderd. Zie montage-instructie.
- ✓ Deur is open.

### 4.2.1 Plat deurscharnier verwijderen

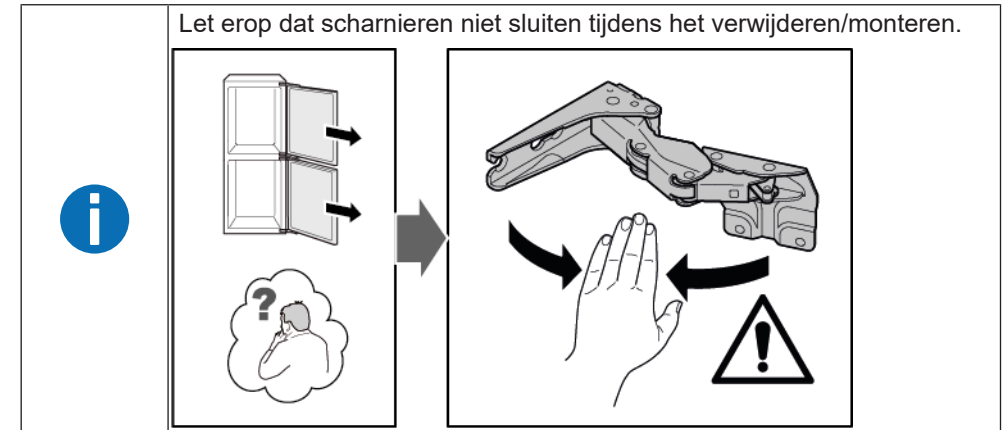

1. Verwijder vier scharnierafdekkingen.

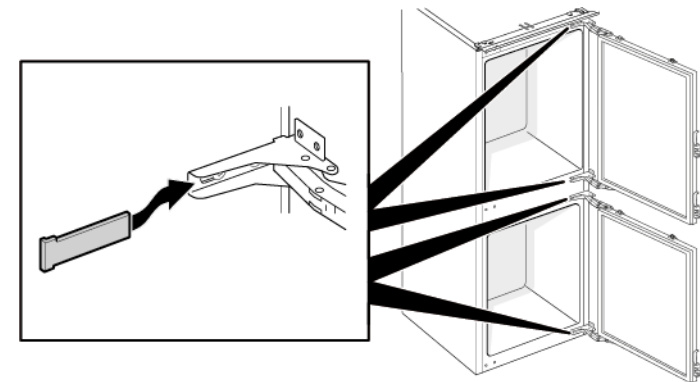

## Reparatie

2. 1. Draai vier schroeven los (1).  
2. Schuif de bovendeur eruit en verwijder hem (2).

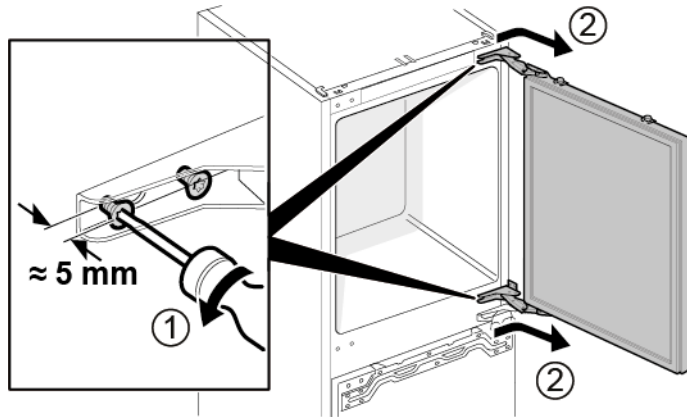

3. 1. Verwijder vier schroeven (1).  
2. Verwijder scharnieren (2).

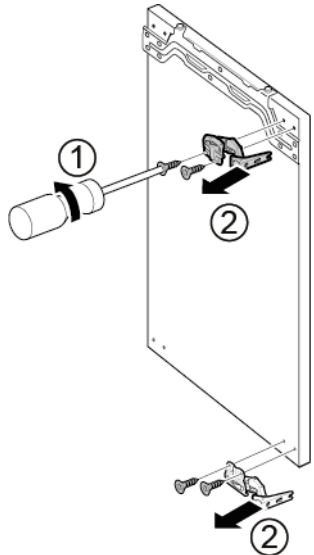

 Scharnieren van bovendeur worden verwijderd.

4. 1. Draai vier schroeven los (1).  
2. Schuif de onderdeur eruit en verwijder hem (2).

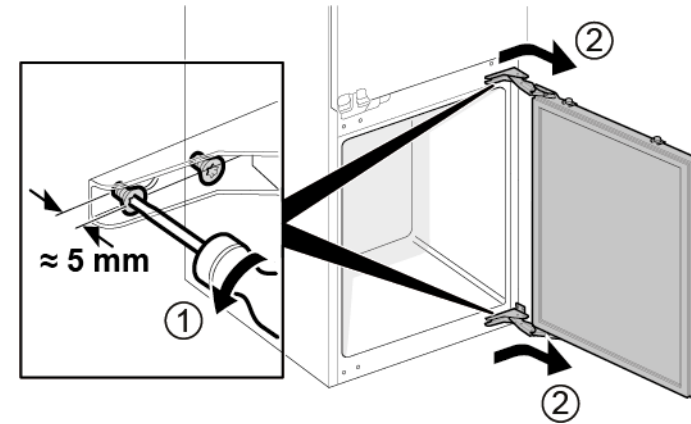

5. 1. Verwijder vier schroeven (1).  
2. Verwijder scharnieren (2).

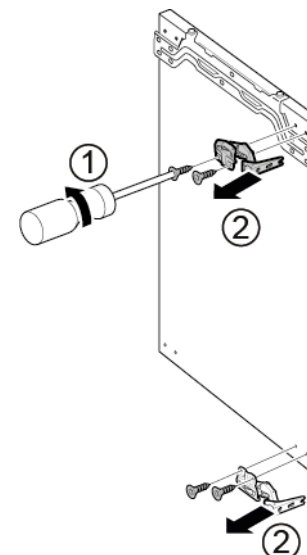

 Scharnieren van onderdeur worden verwijderd.

## **4.2.2 Plat scharnier monteren**

- ▶ Monteer in omgekeerde volgorde.

## 4.3 Sleepscharnier vervangen

### Speciale hulpmiddelen:

Torxbit TX20 6,3 mm (1/4") [00340865]



#### WAARSCHUWING

#### Zware, omvangrijke apparaten!

Rug- en spierletsel

- ▶ De werkzaamheid van het verwijderen van de apparaatdeur mag alleen worden uitgevoerd door speciaal opgeleid personeel.
- ▶ Om het apparaat te verplaatsen zijn twee mensen nodig.
- ▶ Gebruik alleen geschikte gereedschappen en apparatuur.



#### VOORZICHTIG

#### Scherpe randen!

Snijletsel

- ▶ Draag veiligheidshandschoenen.



#### VOORZICHTIG

#### Gevaar voor vallende onderdelen als gevolg van losgeraakte schroeven!

Letsel als gevolg van vallende onderdelen.

- ▶ Beveilig component tegen vallen.



#### LET OP!

#### Gevaar voor vallende onderdelen als gevolg van losgeraakte schroeven!

Schade aan andere onderdelen van het apparaat of bij de klant thuis bijvoorbeeld aan de vloer.

- ▶ Beveilig component tegen vallen.

### Voorwaarde:

- ✔ Apparaat is losgekoppeld van de stroomvoorziening.
- ✔ Meubeldeur en apparaatdeur zijn gescheiden. Zie montage-instructie.

## 4.3.1 Sleepscharnier verwijderen

1. Draai de twee schroeven los (1).
2. Verwijder het bovenste scharnier van de bovendeur (2).
3. Verwijder de bovendeur (3).
4. Draai de twee schroeven los (4).
5. Verwijder het bovenste scharnier van de onderdeur (5).
6. Verwijder de onderdeur (6).

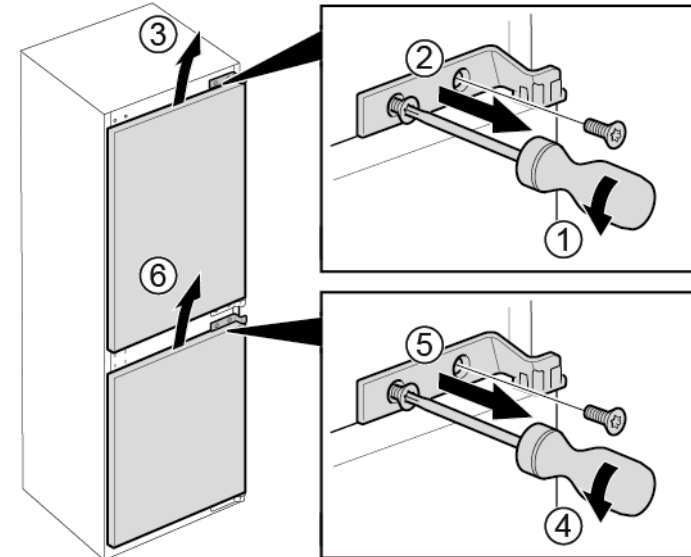

## Reparatie

2. 1. Verwijder vier schroeven (1).
2. Verwijder de onderste scharnieren (2).

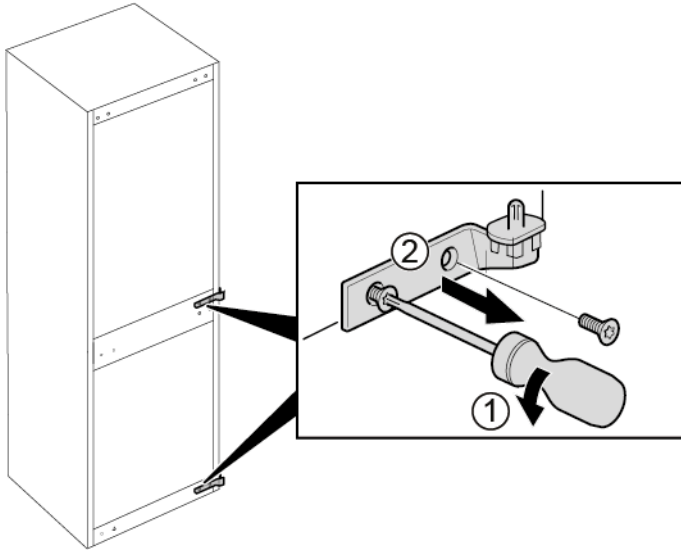

 Scharnieren worden verwijderd.

### 4.3.2 Sleepscharnier monteren

- ▶ Monteer in omgekeerde volgorde.

### 4.4 Deurrek vervangen

Voorwaarde:

- ✔ Deur is open.

#### 4.4.1 Deurrek verwijderen

- ▶ Licht het deurrek omhoog.

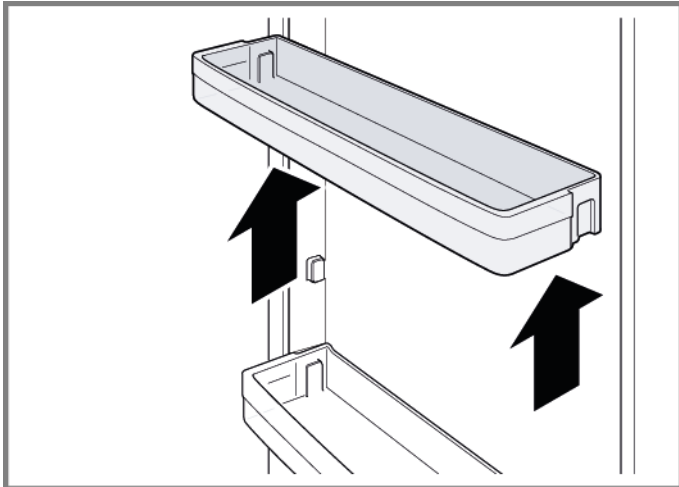

➡ Deurrek wordt verwijderd.

#### 4.4.2 Deurrek monteren

- ▶ Monteer in omgekeerde volgorde.

## 4.5 Plateau vervangen

Voorwaarde:

- ✔ Deur is open.

### 4.5.1 Plateau verwijderen

- ▶ Trek het plateau eruit.

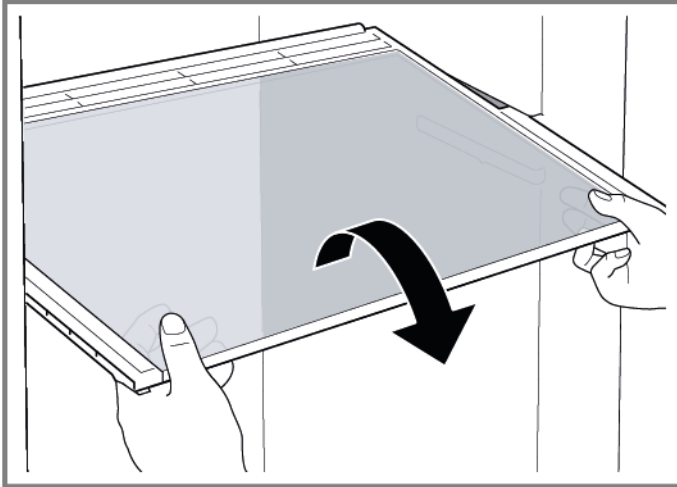

➡ Plateau wordt verwijderd.

### 4.5.2 Plateau monteren

- ▶ Monteer in omgekeerde volgorde.



## 4.6 Uittrekbaar plateau vervangen

Voorwaarde:

- ✔ Deur is open.

### 4.6.1 Uittrekbaar plateau verwijderen

1. Trek het uittrekbare plateau naar buiten tot de vergrendeling loskomt.

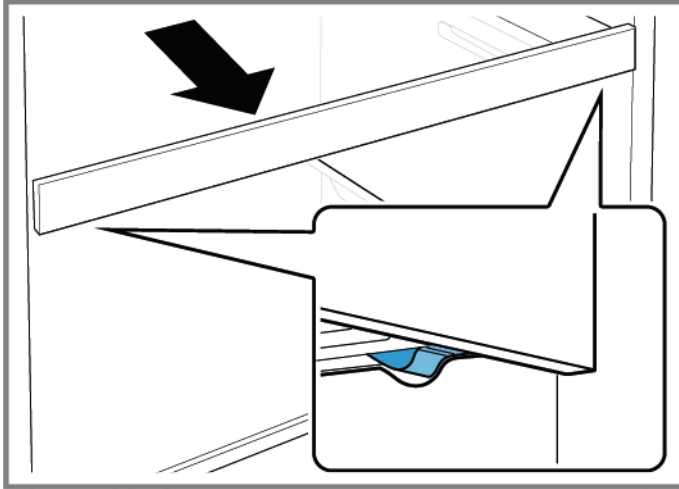

2. Laat het uittrekbare plateau zakken en draai het naar de zijkant eruit.
3. ➡ Het uittrekbare plateau wordt verwijderd.

### 4.6.2 Het uittrekbare plateau installeren

- ▶ Monteer in omgekeerde volgorde.

## 4.7 Plateau van het vriesvak vervangen

Voorwaarde:

- ✔ Deur is open.

### 4.7.1 Plateau van het vriesvak verwijderen

- ▶ Trek het plateau van het vriesvak eruit.

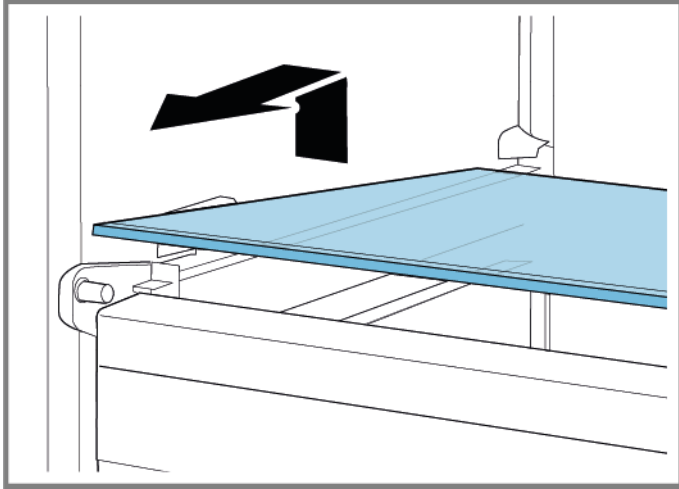

- ➡ Plateau van het vriesvak wordt verwijderd.

### 4.7.2 Plateau van het vriesvak installeren

- ▶ Monteer in omgekeerde volgorde.

## 4.8 Vrieslade vervangen

### Voorwaarde:

- ✔ Deur is open.

### 4.8.1 Vrieslade verwijderen

- ▶ 1. Trek de vrieslade er helemaal uit (1).
- ▶ 2. Verwijder de vrieslade (2).

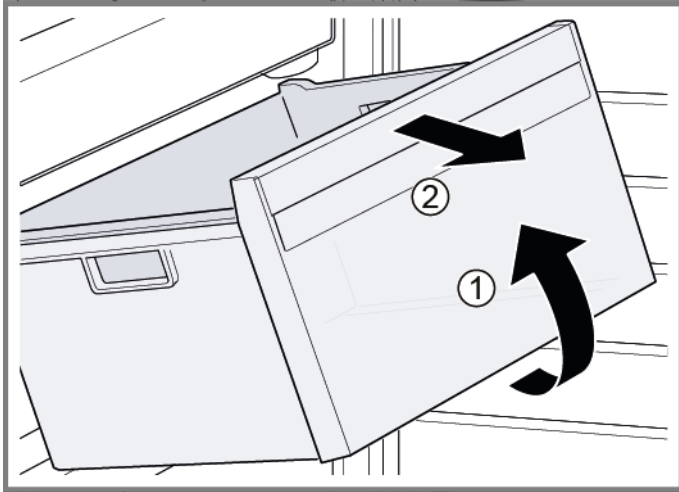

- ➡ Vrieslade wordt verwijderd.

### 4.8.2 Vrieslade installeren

- ▶ Monteer in omgekeerde volgorde.

## 4.9 Groente- en fruitlade vervangen

Voorwaarde:

- ✔ Deur is open.

### 4.9.1 Groente- en fruitlade verwijderen

- ▶ 1. Trek de lade er helemaal uit (1).
- ▶ 2. Verwijder de lade (2).

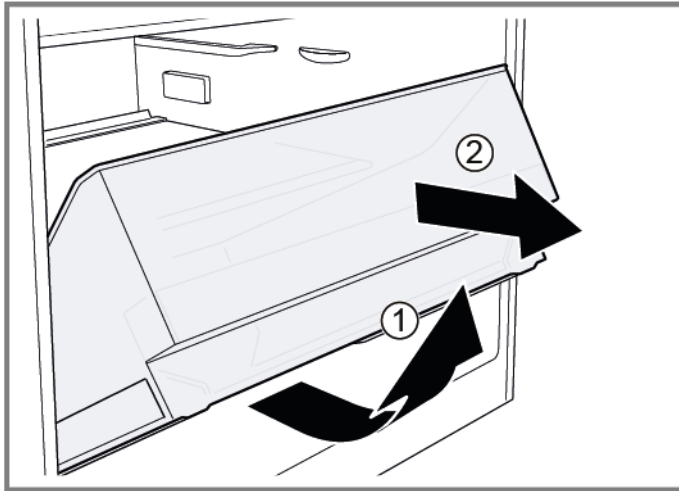

- ➡ Lade wordt verwijderd.

### 4.9.2 Groente- en fruitlade installeren

- ▶ Monteer in omgekeerde volgorde.

## 4.10 Tussenschot en afdekplaat van de groente- en fruitlade vervangen

### Voorwaarde:

- ✓ Deur is open.

### 4.10.1 Tussenschot en afdekplaat van de groente- en fruitlade verwijderen

1. Haal de glasplaat van het tussenschot af.

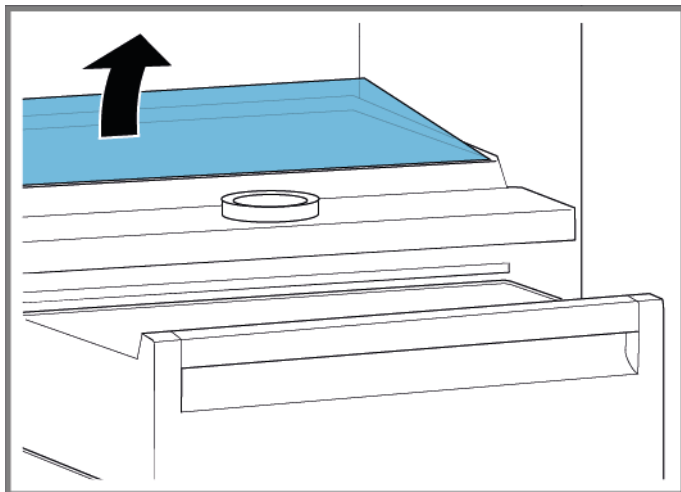

2. [Verwijder de groente- en fruitlade. → 116](#)

3. 1. Druk op de hendel aan de onderkant aan beide kanten van het tussenschot (1).  
2. Trek het tussenschot naar voren (2).

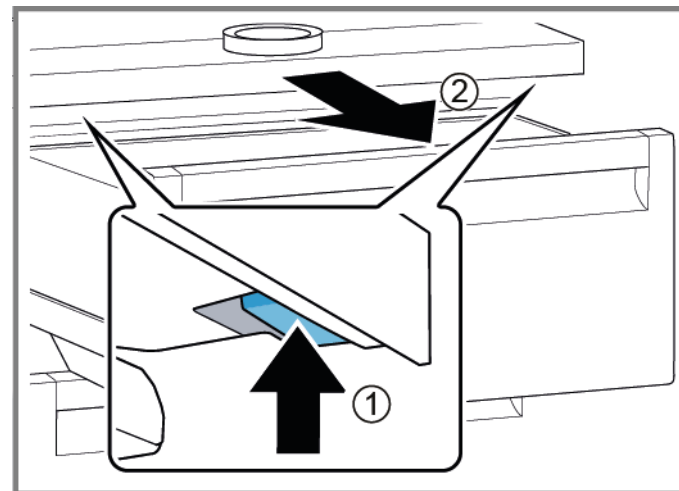

4. Til het tussenschot op en zwenk het er naar de zijkant uit.  
➡ Tussenschot wordt verwijderd.
5. 1. Til de afdekplaat van de groente- en fruitlade verwijderen op.  
2. Trek de afdekplaat van de groente- en fruitlade naar voren en zwenk hem er naar de zijkant uit.  
➡ Afdekplaat van de groente- en fruitlade wordt verwijderd.

### 4.10.2 Tussenschot en afdekplaat van de groente- en fruitlade installeren

- ▶ Monteer in omgekeerde volgorde.

## 4.11 Verskoellade vervangen

### Voorwaarde:

- ✔ Deur is open.

### 4.11.1 Verskoellade verwijderen

- ▶ 1. Kantel de verskoellade naar voren (1).
- ▶ 2. Verwijder de verskoellade (2).

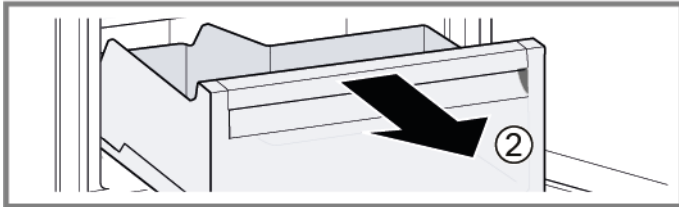
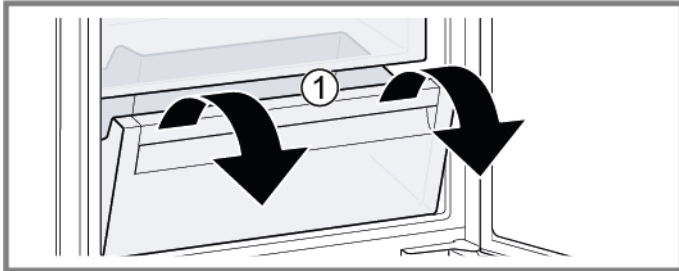

➡ Verskoellade wordt verwijderd.

### 4.11.2 Verskoellade installeren

- ▶ Monteer in omgekeerde volgorde.

## 4.12 Uittrekbare lade vervangen

Voorwaarde:

- ✔ Deur is open.

### 4.12.1 Uittrekbare lade verwijderen

- ▶ 1. Kantel de uittrekbare lade naar voren (1).
- ▶ 2. Verwijder de uittrekbare lade (2).

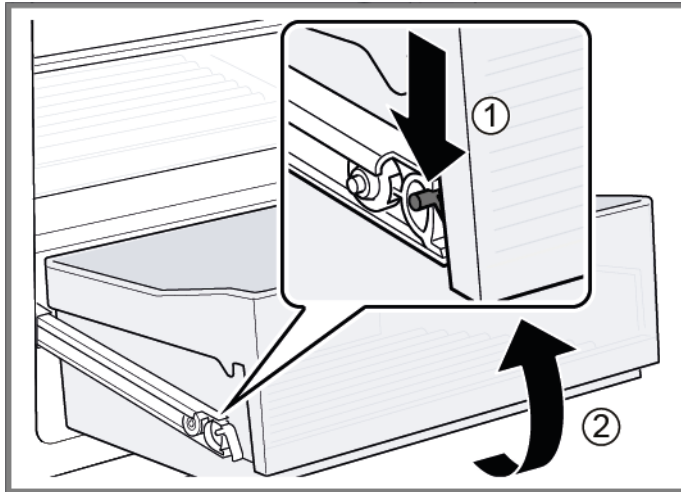



➡ Uittrekbare lade wordt verwijderd.

### 4.12.2 Uittrekbare lade monteren

- ▶ Monteer in omgekeerde volgorde.

## 4.13 LED-verlichting vervangen

### Speciale hulpmiddelen:

-  Speciaal gereedschap [00342180]
-  Sleufschroevendraaier Kop 2,4 mm x 0,4 mm x 60 mm, in de set [00341820]

 Uw apparaat heeft een onderhoudsvrije LED-verlichting. Deze verlichting mag alleen maar door de klantenservice of geautoriseerde monteurs worden vervangen!

 **GEVAAR**  
**Gevaar voor een elektrische schok aan stroomvoerende onderdelen!**  
Levensgevaar door elektrische schokken in geval van een ondeskundige reparatie

- ▶ Elektrische onderdelen moeten door gekwalificeerde elektriciens worden gerepareerd.
- ▶ Laat na de reparatie een veiligheidstest conform VDE 0701 of de landspecifieke regelgeving uitvoeren.



 **GEVAAR**  
**Gevaar voor een elektrische schok aan stroomvoerende onderdelen!**  
Dood door elektrocutie

- ▶ Haal apparaten minstens 60 seconden voor u met reparaties begint van de stroomvoorziening af.

 **VOORZICHTIG**  
**Scherpe randen!**  
Snijletsel

- ▶ Draag veiligheidshandschoenen.

### Voorwaarde:

-  Apparaat is losgekoppeld is van de stroomvoorziening.
-  Deur is open.
-  Koelvakplateaus worden verwijderd.

## 4.13.1 LED-verlichting verwijderen

1. Haal de afdekking van de LED-verlichting los.

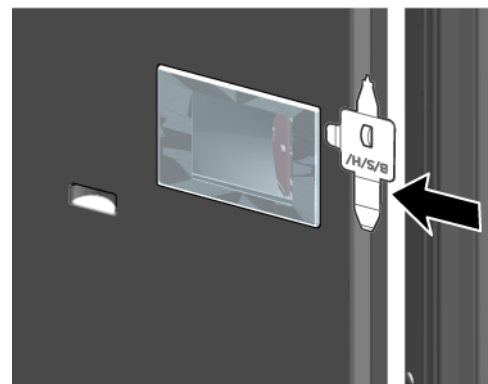

2. Trek de afdekking van de LED-verlichting naar binnen en duw deze tegelijk naar voren.

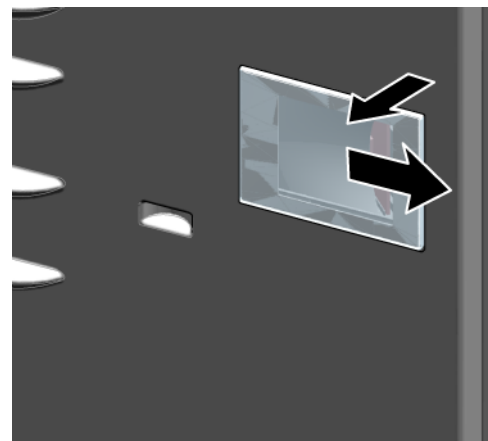



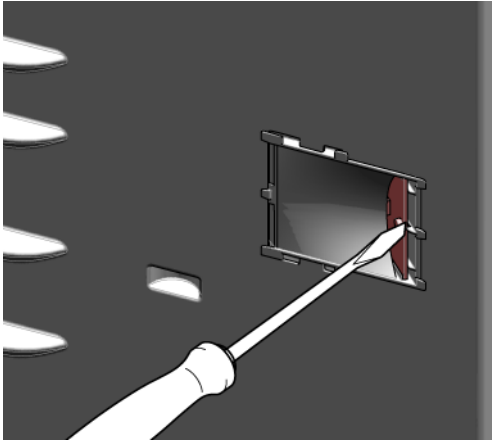

## Reparatie

3. Haal de LED-verlichting los.

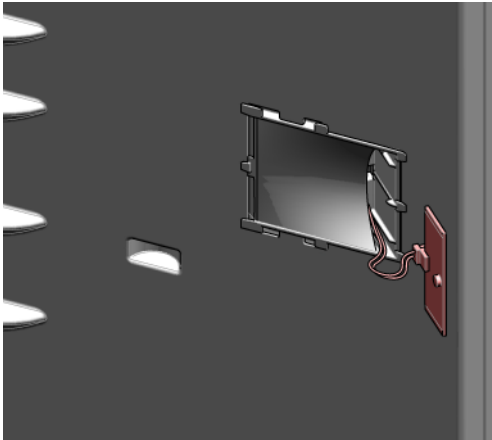

4. Haal de elektrische aansluiting van de LED-verlichting los.





 LED-verlichting wordt verwijderd.

### 4.13.2 LED-verlichting installeren

▶ Monteer in omgekeerde volgorde.

# Repair hints - Fridge-freezer

 <b>Concerning this document</b> .....	<b>123</b>
1.1 Important information .....	123
1.1.1 Purpose.....	123
1.2 Explanation of symbols .....	123
1.2.1 Danger levels.....	123
1.2.2 Hazard symbols .....	123
1.2.3 Structure of the warnings.....	124
1.2.4 General symbols.....	124
 <b>Safety</b> .....	<b>125</b>
2.1 General Safety instructions .....	125
2.1.1 All domestic appliances .....	125
 <b>Tools and aids</b> .....	<b>126</b>
 <b>Repair</b> .....	<b>127</b>
4.1 Replacing door gasket .....	127
4.1.1 Removing door gasket.....	127
4.1.2 Installing door gasket .....	127
4.2 Replacing flat hinge .....	130
4.2.1 Removing flat hinge .....	130
4.2.2 Installing flat hinge .....	132
4.3 Replacing sliding hinge .....	133
4.3.1 Removing sliding hinge .....	133
4.3.2 Installing sliding hinge .....	134
4.4 Replacing door rack.....	135
4.4.1 Removing door rack .....	135
4.4.2 Installing door rack.....	135
4.5 Replacing shelf.....	136
4.5.1 Removing shelf.....	136
4.5.2 Installing shelf.....	136
4.6 Replacing extendable shelf .....	137
4.6.1 Removing extendable shelf.....	137
4.6.2 Installing extendable shelf .....	137
4.7 Replacing freezer compartment shelf.....	138
4.7.1 Removing freezer compartment shelf .....	138
4.7.2 Installing freezer compartment shelf .....	138
4.8 Replacing frozen food container.....	139
4.8.1 Removing frozen food container .....	139
4.8.2 Installing frozen food container .....	139
4.9 Replacing fruit and vegetable container .....	140
4.9.1 Removing fruit and vegetable container .....	140
4.9.2 Installing fruit and vegetable container .....	140
4.10 Replacing partition and cover of fruit and vegetable container.....	141
4.10.1 Removing partition and cover of fruit and vegetable container .....	141
4.10.2 Installing partition and cover of fruit and vegetable container .....	141
4.11 Replacing cool-fresh container .....	142
4.11.1 Removing cool-fresh container .....	142
4.11.2 Installing cool-fresh container .....	142
4.12 Replacing extendable container .....	143
4.12.1 Removing extendable container .....	143
4.12.2 Installing extendable container .....	143
4.13 Replacing LED spot light .....	144
4.13.1 Removing LED spot light.....	144
4.13.2 Installing LED spot light .....	145

# **i** Concerning this document

## 1.1 Important information

### 1.1.1 Purpose

These repair hints support consumer to repair appliances by himself according to the applicable eco-design regulation (as of 03/2021).

They contain information how to exchange defined spare parts including warnings and risks.

In case of questions, please contact our customer service. We will only be liable for damages if the repair hints have been followed properly.

## 1.2 Explanation of symbols

### 1.2.1 Danger levels

The warning levels consist of a symbol and a signal word. The signal word indicates the severity of the danger.









Warning level	Meaning
	Non-observance of the warning message will result in death or serious injuries.
	Non-observance of the warning message could result in death or serious injuries.
	Non-observance of the warning message could result in minor injuries.
	Non-observance of the warning message could result in damage to property.

Table 1: Danger levels

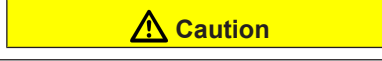
### 1.2.2 Hazard symbols

Hazard symbols are symbolic representations which give an indication of the kind of danger.

The following hazard symbols are used in this document:

Hazard symbol	Meaning
	General warning message
	Danger from electrical voltage
	Risk of explosion
	Danger of cuts
	Danger of crushing

## Concerning this document



Hazard symbol	Meaning
	Danger from hot surfaces
	Danger from strong magnetic field
	Danger from non-ionizing radiation

Table 2: Hazard symbols

### 1.2.3 Structure of the warnings

Warnings in this document have a standardised appearance and a standardised structure.



	<div style="background-color: red; color: white; padding: 2px; text-align: center;"> <b>Danger</b></div> <p><b>Type and source of danger!</b> Possible consequences of ignoring the danger / warning.</p> <ul style="list-style-type: none"> <li>▶ Measures and prohibitions for preventing the danger.</li> </ul>
--	---

The following example shows a warning that warns against electric shock due to live parts. The measure for avoiding the danger is mentioned.

	<div style="background-color: red; color: white; padding: 2px; text-align: center;"> <b>Danger</b></div> <p><b>Risk of electric shock due to live parts!</b> Death by electrocution</p> <ul style="list-style-type: none"> <li>▶ Disconnect appliances from electrical supply at least 60 seconds before starting repairs.</li> </ul>
--	---

### 1.2.4 General symbols

The following general symbols are used in this document:

Gen. symbol	Meaning
	Identification of a special tip (text and/or graphic)
	Identification of a simple tip (only text)
	Identification of a link to a video tutorial





Gen. symbol	Meaning
	Identification of required tools
	Identification of required preconditions
	Identification of a condition (if ..., then ...)
	Identification of a result
[Start]	Identification of a key or button
[00123456]	Identification of a material number
Status	Identification of displayed text / window (in the appliance's display)

Table 3: General symbols

## 2.1 General Safety instructions

### 2.1.1 All domestic appliances

#### **Risk of electric shock due to live parts!**

- Errors by repairs involving electrical components can lead to electrical shock!
- Disconnect the appliance from the mains for at least 60 seconds before starting work.
- After the repair have a safety test according VDE 0701 or country-specific regulations performed.

#### **Risk of injury from sharp edges!**

- Wear protective gloves.

#### **Risk of crushing during repair, maintenance, troubleshooting and service due to heavy and moving components**

- Wear protective shoes.
- Secure heavy components from falling down.
- Do not stick body parts into moving components.



#### **Risk to the appliance's safety / function!**

- Only use original spare parts.

#### **Risk of damage to electrostatically sensitive components (ESDs)!**

- Do not touch the modules, including connections and conductor paths.

## Tools and aids

Designation	Details	Images
Protection cloth [00342013]	60 cm x 50 cm	
Torx Bit TX20 [00340865]	6,3 mm (1/4")	
Special tool [00342180]		

## 4.1 Replacing door gasket

### Prerequisite:

-  Door is open.

### 4.1.1 Removing door gasket

1. Release door gasket from the groove on right and left corner.

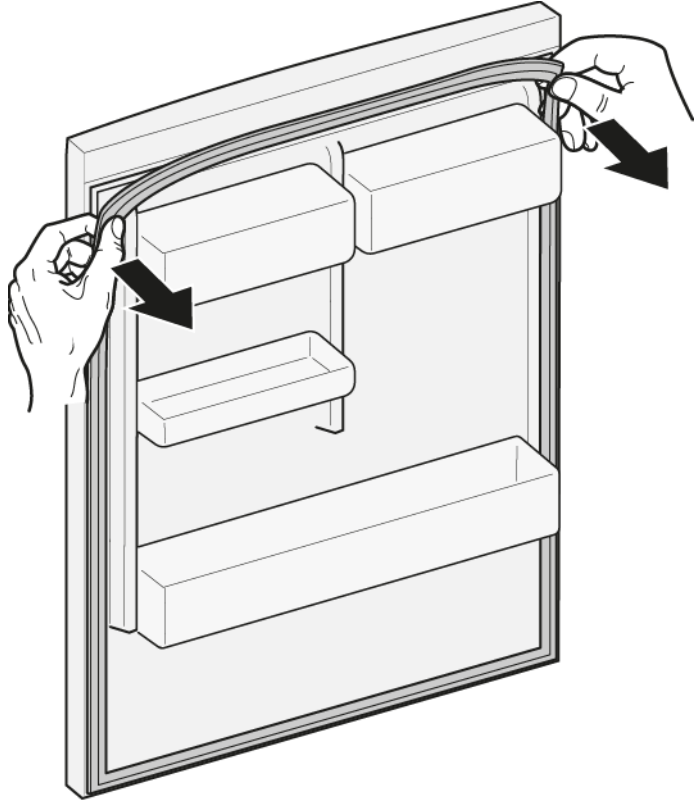

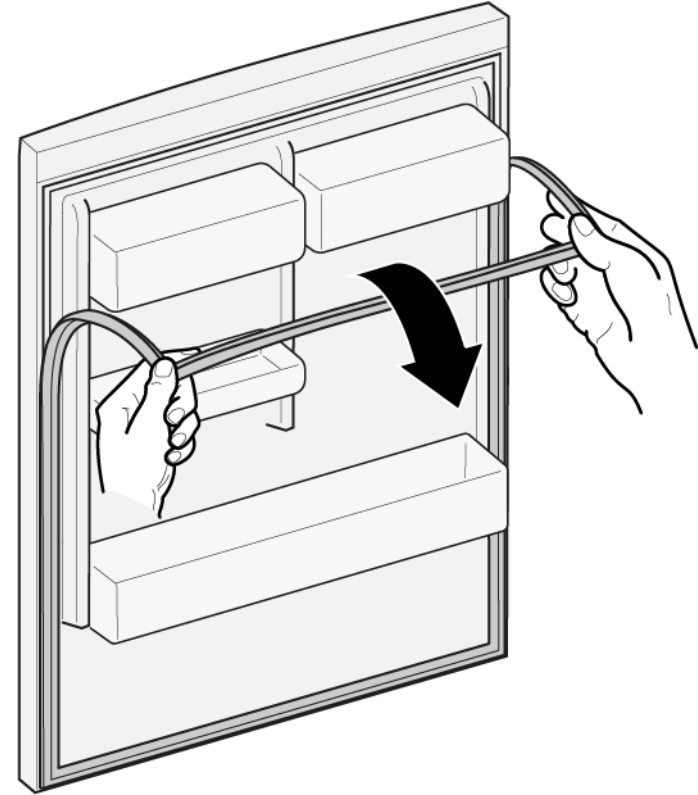

2. Pull out door gasket from groove.



-  Door gasket is removed.

### 4.1.2 Installing door gasket

	Thickness of new door gasket may deviate slightly from thickness of old door gasket. This will not affect closing behavior and long-term function.
	If your appliance has adjustable hinges or hinge attachments, you can optimize the closing behavior subsequently.
	Small side holes in door gasket are functional (required for ventilation). These are not production faults.

## Repair

1. Check groove for gasket for damage.

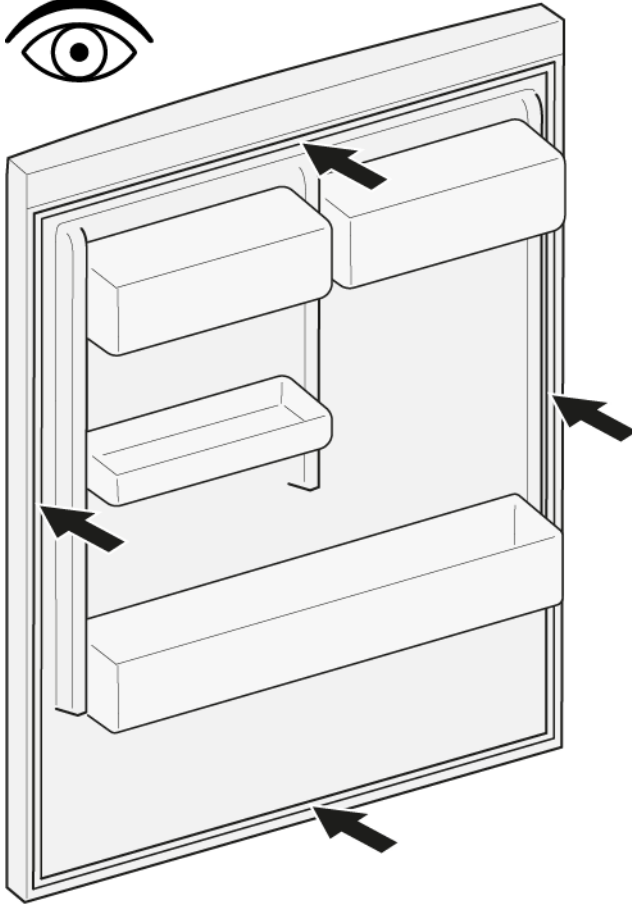

4. Push corners of gasket at the top and bottom to the groove.

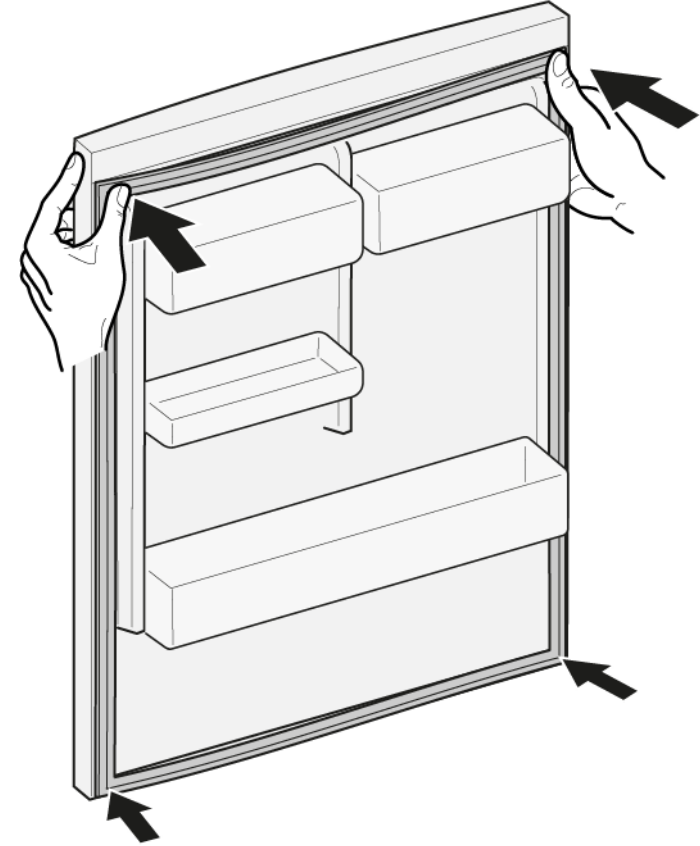

2.  If groove for gasket is it is damaged.  
- Contact customer service.

3.  Slight deformation of door gasket is normal and does not affect its function. It is recommended to straighten door gasket before inserting it into appliance.

Heat door gasket with a hair dryer or hot water and manually reshape it.



5. Press whole gasket step by step into the groove.

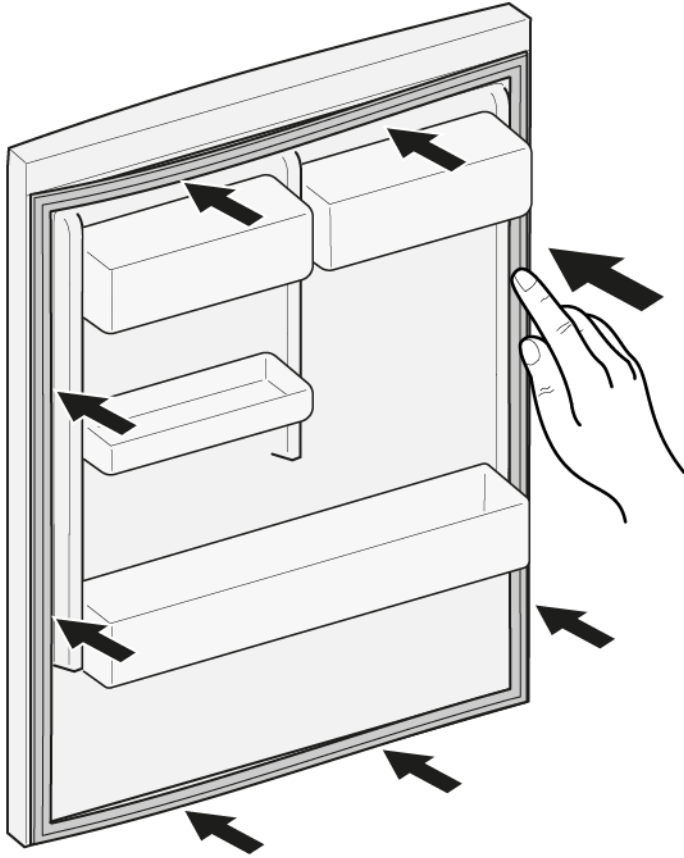



-  Door gasket is installed.

## 4.2 Replacing flat hinge

### Required tools:

 Torx Bit TX20                      6,3 mm (1/4")                      [00340865]

	<b>Warning</b>
	<p><b>Heavy, bulky appliances!</b> Back and muscle injuries</p> <ul style="list-style-type: none"> <li>▶ Appliance door removal operation should only be carried out by trained specialists.</li> <li>▶ To move the appliance, two people are required.</li> <li>▶ Use only suitable tools and equipment.</li> </ul>



	<b>Caution</b>
	<p><b>Sharp edges!</b> Cut injuries</p> <ul style="list-style-type: none"> <li>▶ Wear protective gloves.</li> </ul>

	<b>Caution</b>
	<p><b>Open hinge area!</b> Finger crushing / entrapment</p> <ul style="list-style-type: none"> <li>▶ Do not reach into the hinge area.</li> <li>▶ Wear protective gloves.</li> </ul>

	<b>Caution</b>
	<p><b>Risk of falling parts due to released screws!</b> Injury because of falling parts.</p> <ul style="list-style-type: none"> <li>▶ Secure component from falling down.</li> </ul>

	<b>Notice</b>
	<p><b>Risk of falling parts due to released screws!</b> Damage to other parts of the appliance or at customers home e.g. bottom.</p> <ul style="list-style-type: none"> <li>▶ Secure component from falling down.</li> </ul>

### Prerequisite:

-  Appliance is disconnected from power supply.
-  Furniture door are removed. See Installation Instruction.
-  Door is open.

### 4.2.1 Removing flat hinge

Take care that hinges do not close during removal / installation.



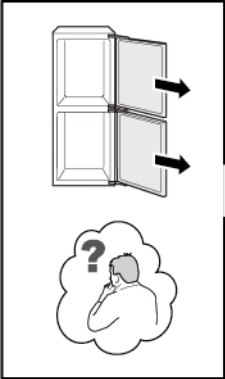
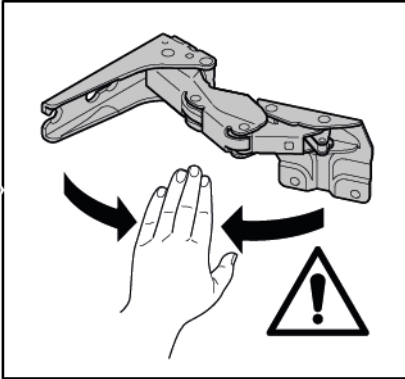

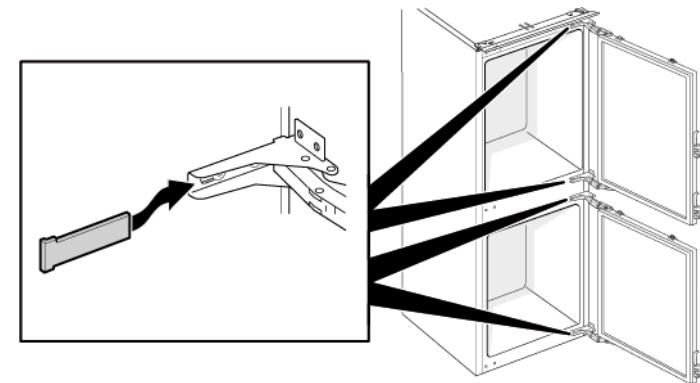

1. Remove four hinge covers.



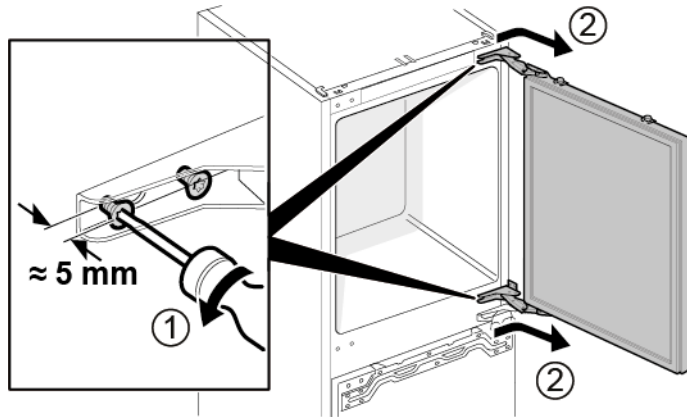

## Repair

2. 1. Loosen four screws (1).  
2. Slide out and remove upper door (2).

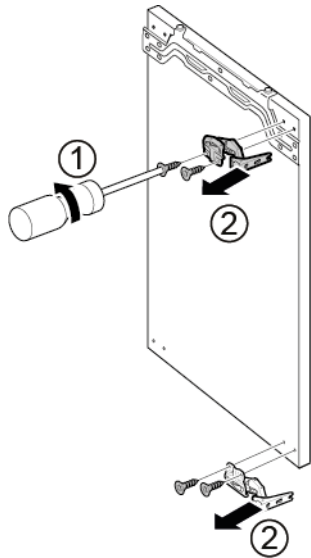

3. 1. Remove four screws (1).  
2. Remove hinges (2).



 Upper door hinges are removed.

4. 1. Loosen four screws (1).  
2. Slide out and remove lower door (2).

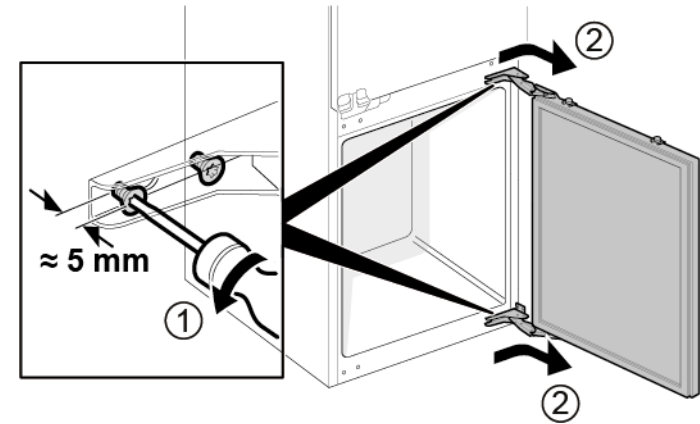

5. 1. Remove four screws (1).  
2. Remove hinges (2).

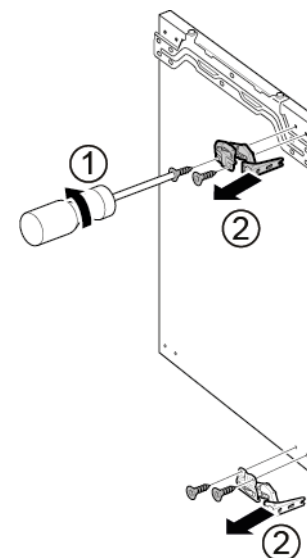

 Lower door hinges are removed.

#### **4.2.2 Installing flat hinge**

- ▶ Install in reverse order.

## 4.3 Replacing sliding hinge

### Required tools:

 Torx Bit TX20                      6,3 mm (1/4")                      [00340865]



### Warning

#### Heavy, bulky appliances!

Back and muscle injuries

- ▶ Appliance door removal operation should only be carried out by trained specialists.
- ▶ To move the appliance, two people are required.
- ▶ Use only suitable tools and equipment.



### Caution

#### Sharp edges!

Cut injuries

- ▶ Wear protective gloves.



### Caution

#### Risk of falling parts due to released screws!

Injury because of falling parts.

- ▶ Secure component from falling down.





### Notice

#### Risk of falling parts due to released screws!

Damage to other parts of the appliance or at customers home e.g. bottom.

- ▶ Secure component from falling down.

### Prerequisite:

-  Appliance is disconnected from power supply.
-  Furniture door and appliance door are separated. See Installation Instruction.

### 4.3.1 Removing sliding hinge

1. 1. Unscrew two screws (1).
2. 2. Remove upper door upper hinge (2).
3. 3. Remove upper door (3).
4. 4. Unscrew two screws (4).
5. 5. Remove lower door upper hinge (5).
6. 6. Remove lower door (6).

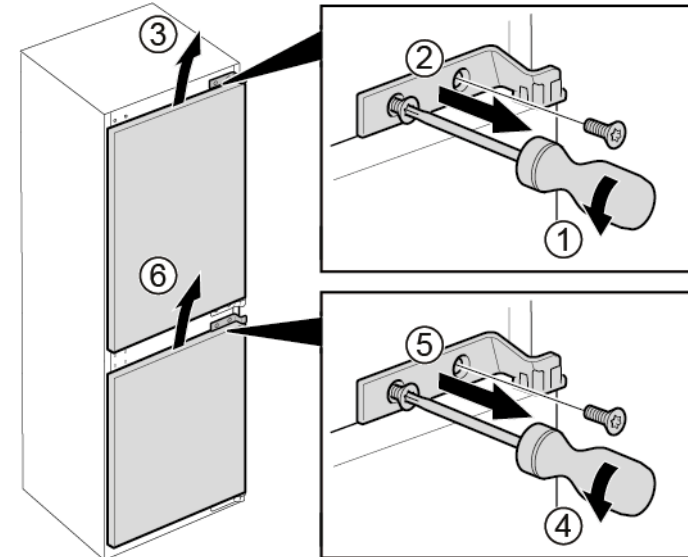

2. 1. Remove four screws (1).
2. Remove lower hinges (2).

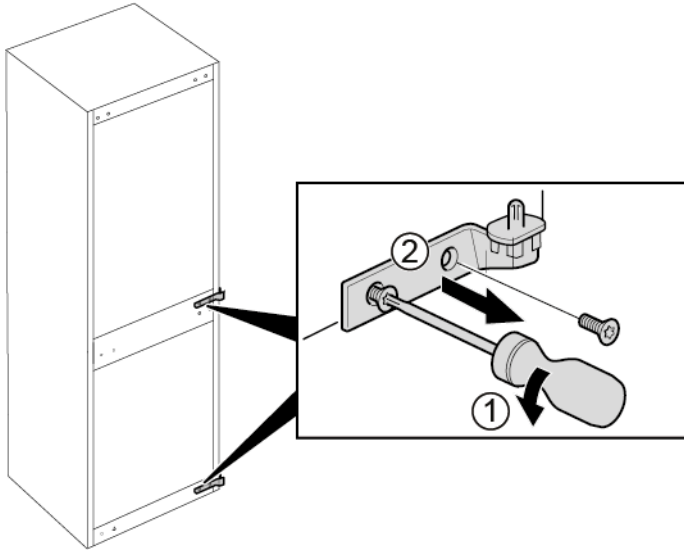

 Hinges are removed.

### 4.3.2 Installing sliding hinge

- ▶ Install in reverse order.

## 4.4 Replacing door rack

### Prerequisite:

- ✔ Door is open.

### 4.4.1 Removing door rack

- ▶ Lift door rack upwards.

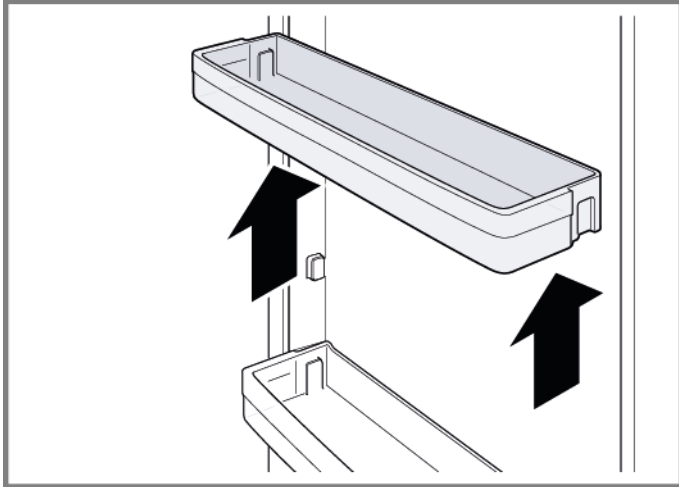

- ➡ Door rack is removed.

### 4.4.2 Installing door rack

- ▶ Install in reverse order.

## 4.5 Replacing shelf

### Prerequisite:

- ✔ Door is open.

### 4.5.1 Removing shelf

- ▶ Pull out shelf.

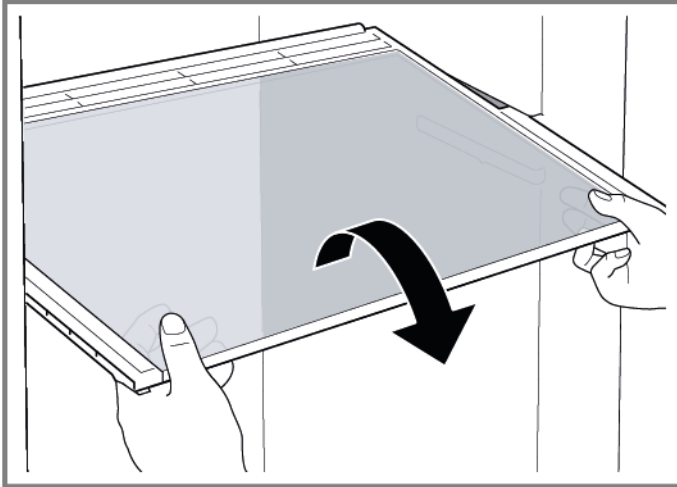

- ➡ Shelf is removed.

### 4.5.2 Installing shelf

- ▶ Install in reverse order.



## 4.6 Replacing extendable shelf

### Prerequisite:

- ✔ Door is open.

### 4.6.1 Removing extendable shelf

1. Pull out extendable shelf until the locking catch is released.

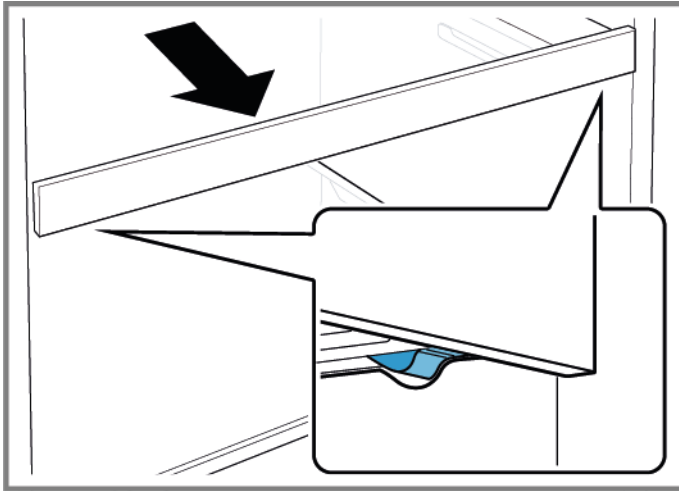

2. Lower extendable shelf and swing it out to the side.
3. ➡ Extendable shelf is removed.

### 4.6.2 Installing extendable shelf

- ▶ Install in reverse order.

## 4.7 Replacing freezer compartment shelf

### Prerequisite:

- ✔ Door is open.

### 4.7.1 Removing freezer compartment shelf

- ▶ Pull out freezer compartment shelf.

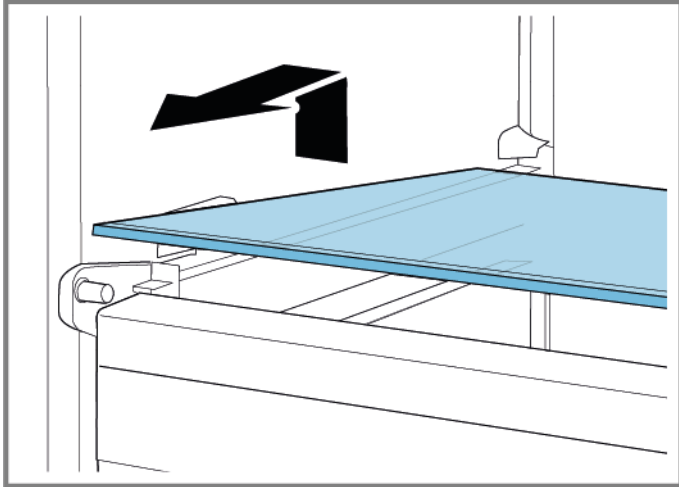

- ➡ Freezer compartment shelf is removed.

### 4.7.2 Installing freezer compartment shelf

- ▶ Install in reverse order.

## 4.8 Replacing frozen food container

### Prerequisite:

- ✔ Door is open.

### 4.8.1 Removing frozen food container

- ▶ 1. Pull out frozen food container all the way (1).
- ▶ 2. Remove frozen food container (2).

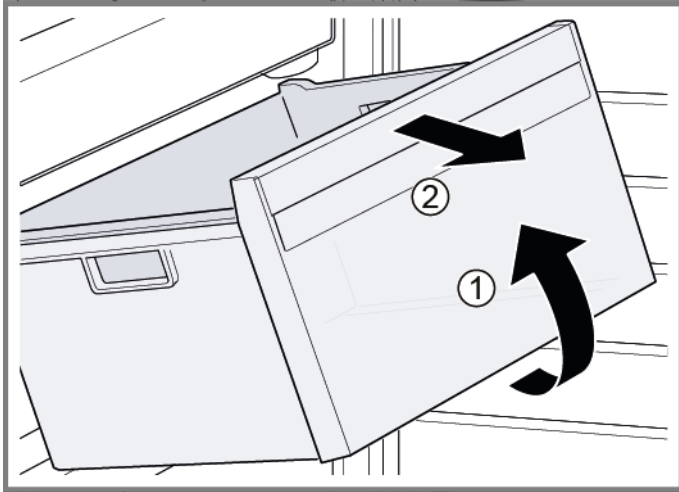

- ➡ Frozen food container is removed.

### 4.8.2 Installing frozen food container

- ▶ Install in reverse order.

## 4.9 Replacing fruit and vegetable container

### Prerequisite:

- ✔ Door is open.

### 4.9.1 Removing fruit and vegetable container

- ▶ 1. Pull container out all the way (1).
- ▶ 2. Remove container (2).

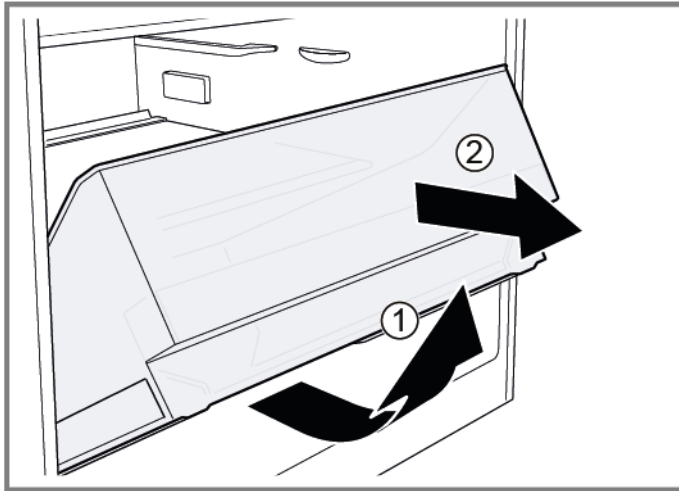

- ➡ Container is removed.

### 4.9.2 Installing fruit and vegetable container

- ▶ Install in reverse order.

## 4.10 Replacing partition and cover of fruit and vegetable container

### Prerequisite:

- ✔ Door is open.

### 4.10.1 Removing partition and cover of fruit and vegetable container

1. Remove glass plate from partition.

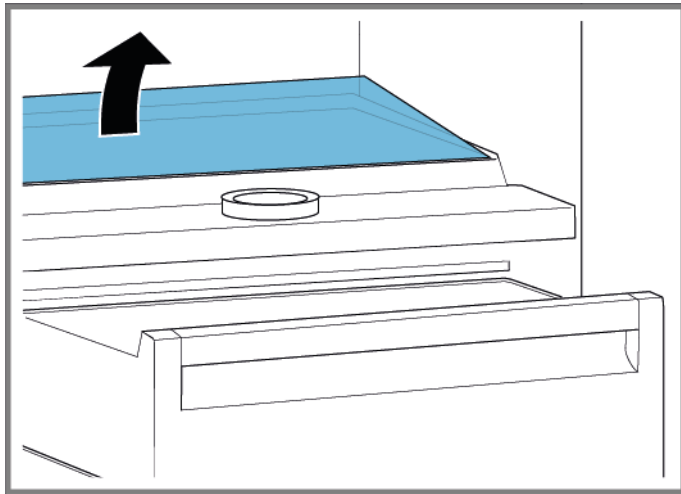

2. [Remove fruit and vegetable container.](#) → [Page 140](#)

3. 1. Press lever on the underside on both partition sides (1).
2. Pull the partition forwards (2).

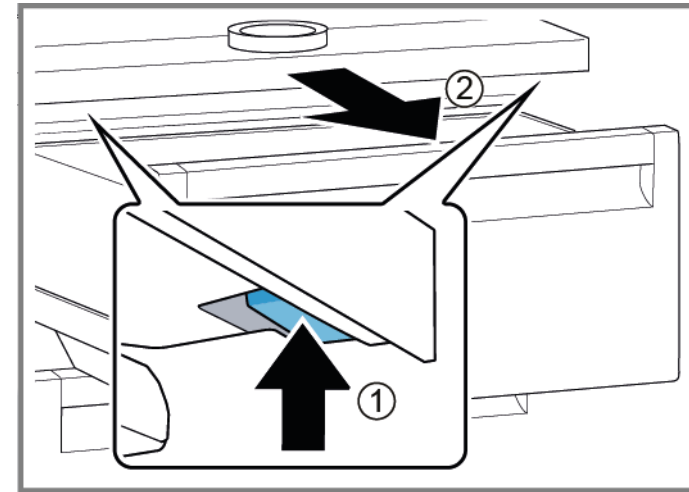

4. Lift the partition and swivel it out to the side.  
➡ Partition is removed.
5. 1. Lift the cover of fruit and vegetable container.  
2. Pull cover of fruit and vegetable container forwards and swivel it out to the side.  
➡ Cover of fruit and vegetable container is removed.

### 4.10.2 Installing partition and cover of fruit and vegetable container

- ▶ Install in reverse order.

## 4.11 Replacing cool-fresh container

### Prerequisite:

- ✔ Door is open.

### 4.11.1 Removing cool-fresh container

- ▶ 1. Tilt cool-fresh container forwards (1).
- ▶ 2. Remove cool-fresh container (2).

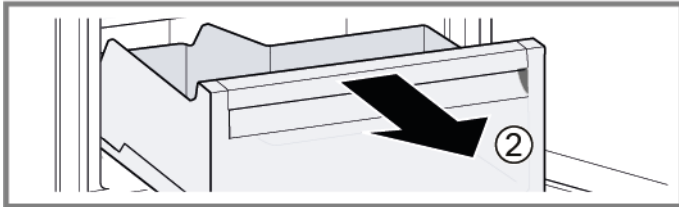
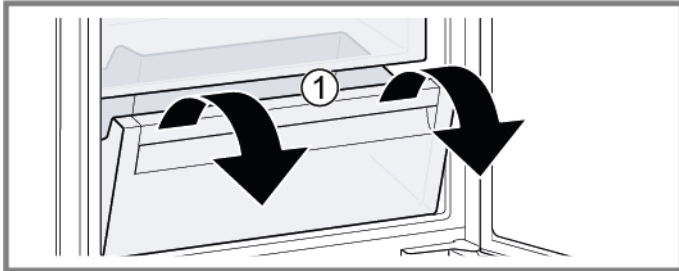

➡ Cool-fresh container is removed.

### 4.11.2 Installing cool-fresh container

- ▶ Install in reverse order.

## 4.12 Replacing extendable container

### Prerequisite:

- ✔ Door is open.

### 4.12.1 Removing extendable container

- ▶ 1. Tilt extendable container forwards (1).
- ▶ 2. Remove extendable container (2).

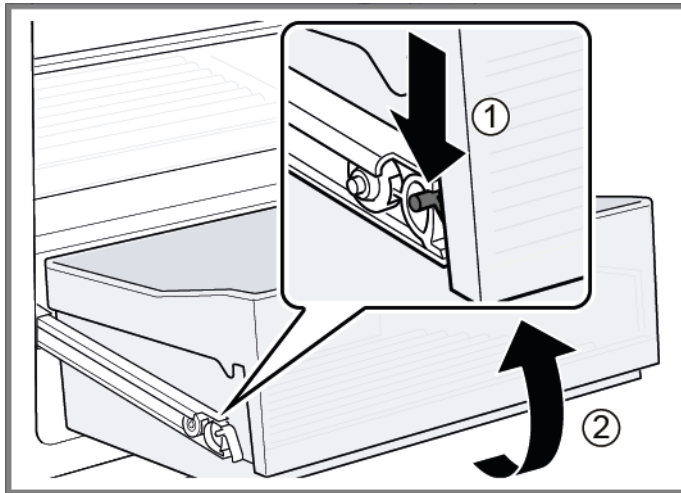

➡ Extendable container is removed.

### 4.12.2 Installing extendable container

- ▶ Install in reverse order.

## 4.13 Replacing LED spot light

### Required tools:

- 🔧 Special tool [00342180]
- 🔧 Slotted screwdriver Blade 2.4 mm x 0.4 mm x 60 mm, in the kit [00341820]

**i** Your appliance features a maintenance-free LED light. These lights may be repaired by customer service or authorised technicians only!

**⚠️ Danger**  
**Risk of electric shock due to live parts!**  
 Danger to life through electric shock in case of improper repair

- ▶ Electric parts should be repaired by a qualified electrician.
- ▶ After the repair have a safety test according VDE 0701 or country-specific regulations performed.

**⚠️ Danger**  
**Risk of electric shock due to live parts!**  
 Death by electrocution

- ▶ Disconnect appliances from electrical supply at least 60 seconds before starting repairs.

**⚠️ Caution**  
**Sharp edges!**  
 Cut injuries

- ▶ Wear protective gloves.

### Prerequisite:

- ✅ Appliance is disconnected from power supply.
- ✅ Door is open.
- ✅ Fridge compartment shelves are removed.

### 4.13.1 Removing LED spot light

1. Release LED spot light cover.

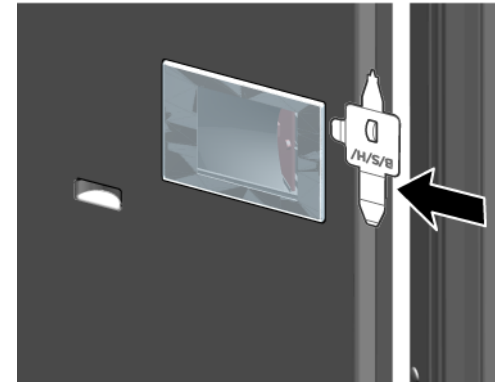

2. Pull LED spot light cover inwards and simultaneously push forwards.

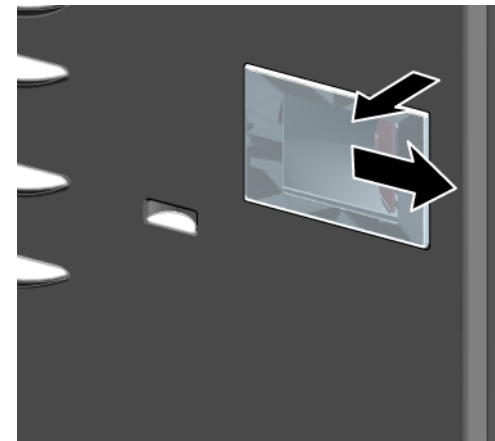



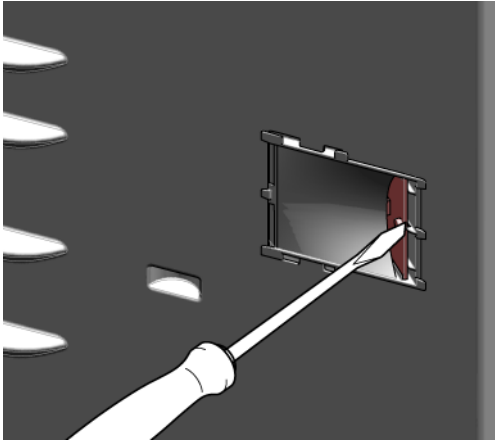

3. Detach LED spot light module.

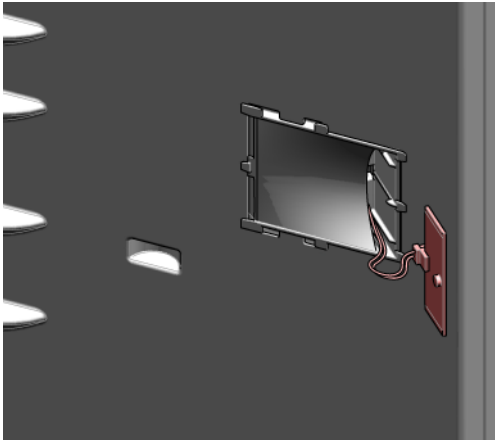

4. Disconnect LED spot light electrical connection.



 LED spot light is removed.

### 4.13.2 Installing LED spot light

▶ Install in reverse order.

# Remonditeave - Kombikülmik

 <b>Selle dokumendiga seoses .....</b>	<b>147</b>
1.1 Tähtis teave .....	147
1.1.1 Eesmärk .....	147
1.2 Sümbolite selgitus .....	147
1.2.1 Ohutasemed .....	147
1.2.2 Ohusümbolid .....	147
1.2.3 Hoiatuste struktuur .....	148
1.2.4 Üldised sümbolid .....	148
 <b>Ohutus.....</b>	<b>149</b>
2.1 Üldised ohutusjuhised .....	149
2.1.1 Kõik kodumasinad .....	149
 <b>Tööriistad ja abinõud.....</b>	<b>150</b>
 <b>Remont.....</b>	<b>151</b>
4.1 Uksetihendi vahetamine .....	151
4.1.1 Uksetihendi eemaldamine .....	151
4.1.2 Uksetihendi paigaldamine .....	151
4.2 Tasapinnalise hinge vahetamine .....	154
4.2.1 Tasapinnalise hinge eemaldamine .....	154
4.2.2 Tasapinnalise hinge paigaldamine .....	156
4.3 Lükandhinge vahetamine .....	157
4.3.1 Lükandhinge eemaldamine .....	157
4.3.2 Lükandhinge paigaldamine .....	158
4.4 Ukseraami vahetamine .....	159
4.4.1 Ukseraami eemaldamine .....	159
4.4.2 Ukseraami paigaldamine .....	159
4.5 Riiuli vahetamine .....	160
4.5.1 Riiuli eemaldamine .....	160
4.5.2 Riiuli paigaldamine .....	160
4.6 Laiendatava riiuli vahetamine .....	161
4.6.1 Laiendatava riiuli eemaldamine .....	161
4.6.2 Laiendatava riiuli paigaldamine .....	161
4.7 Sügavkülmikuosa riiuli vahetamine .....	162
4.7.1 Sügavkülmikuosa riiuli eemaldamine .....	162
4.7.2 Sügavkülmikuosa riiuli paigaldamine .....	162

4.8 Külmutatud toidu mahuti vahetamine .....	163
4.8.1 Külmutatud toidu mahuti eemaldamine .....	163
4.8.2 Külmutatud toidu mahuti paigaldamine .....	163
4.9 Puu- ja köögiviljamahuti vahetamine .....	164
4.9.1 Puu- ja köögiviljamahuti eemaldamine .....	164
4.9.2 Puu- ja köögiviljamahuti paigaldamine .....	164
4.10 Puu- ja köögiviljamahuti vaheseina ja katte vahetamine .....	165
4.10.1 Puu- ja köögiviljamahuti vaheseina ja katte eemaldamine .....	165
4.10.2 Puu- ja köögiviljamahuti vaheseina ja katte paigaldamine .....	165
4.11 Jahutusmahuti vahetamine .....	166
4.11.1 Jahutusmahuti eemaldamine .....	166
4.11.2 Jahutusmahuti paigaldamine .....	166
4.12 Laiendatava mahuti vahetamine .....	167
4.12.1 Laiendatava mahuti eemaldamine .....	167
4.12.2 Laiendatava mahuti paigaldamine .....	167
4.13 LED-kohtvalgusti vahetamine .....	168
4.13.1 LED-kohtvalgusti eemaldamine .....	168
4.13.2 LED-kohtvalgusti paigaldamine .....	169

# **i** Selle dokumendiga seoses

## 1.1 Tähtis teave

### 1.1.1 Eesmärk

Need remondinõuanded toetavad tarbijat seadmete iseseisval remontimisel vastavalt kehtivale ökodisaini määrusele (03/2021).





Need sisaldavad teavet selle kohta, kuidas vahetada teatud varuosi, samuti hoiatusi ning ohtusid.

Küsimuste korral võtke ühendust meie klienditeenindusega. Meie vastutame kahjustuste eest ainult siis, kui remondinõuandeid on õigesti järgitud.

## 1.2 Sümbolite selgitus

### 1.2.1 Ohutasemed

Ohutasemed koosnevad sümbolist ja märksõnast. Märksõna viitab ohu raskusastmele.

Hoiatustase	Tähendus
 <b>OHT</b>	Hoiatusteadete eiramine põhjustab surma või raskeid kehavigastusi.
 <b>HOIATUS</b>	Hoiatusteadete eiramine võib põhjustada surma või raskeid kehavigastusi.
 <b>ETTEVAATUST!</b>	Hoiatusteadete eiramine võib põhjustada kergeid kehavigastusi.
 <b>TÄHELEPANU!</b>	Hoiatusteadete eiramine võib põhjustada varakahju.

Tabel 1: Ohutasemed



### 1.2.2 Ohusümbolid

Ohusümbolid on sümboolsed kujutised, mis viitavad ohu laadile.

Selles dokumendis kasutatakse alljärgnevaid ohusümboleid.

Ohusümbol	Tähendus
	Üldine ohuteade
	Elektripingest tingitud oht
	Plahvatusoht
	Lõikeoht
	Muljumisoht

## **i** Selle dokumendiga seoses

Ohusümbol	Tähendus
	Kuumadest pindadest tingitud oht
	Tugevast magnetväljast tingitud oht
	Mitteioniseerivast kiirgusest tingitud oht

Tabel 2: Ohusümbolid

### 1.2.3 Hoiatuste struktuur

Selles dokumendis olevatel hoiatustel on standardiseeritud väljanägemine ja standardiseeritud struktuur.



	<div style="background-color: red; color: white; padding: 2px; display: inline-block;"><b>⚠ OHT</b></div> <b>Ohu tüüp ja allikas!</b> Ohu/hoiatuse eiramise võimalikud tagajärjed. ▶ Meetmed ja ettevaatusabinõud ohu vältimiseks.
--	---





Alljärgnevas näiteks on näidatud hoiatust, millega hoiatatakse liikuvatest osadest tingitud elektrilöögiuhtude eest. Nimetatud on meetet ohu vältimiseks.

	<div style="background-color: red; color: white; padding: 2px; display: inline-block;"><b>⚠ OHT</b></div> <b>Liikuvatest osadest tingitud elektrilöögi oht!</b> Elektrilöögist tingitud surm ▶ Enne remonditöödega alustamist ühendage seadmed elektrivõrgust lahti vähemalt 60 sekundit varem.
---	--

### 1.2.4 Üldised sümbolid

Selles dokumendis kasutatakse alljärgnevaid üldisi sümboleid.

Üld. sümbol	Tähendus
	Erinõuande tunnus (tekst ja/või graafik)
	Lihtsa nõuande tunnus (ainult tekst)
	Videojuhendi lingi tunnus

Üld. sümbol	Tähendus
	Vajalike tööriistade tunnus
	Vajalike eeltingimuste tunnus
	Seisukorra tunnus (kui..., siis...)
	Tulemuse tunnus
[Start]	Klahvi või nupu tunnus
[00123456]	Materjalinumbriga tunnus
Olek	Kuvatava teksti/akna tunnus (seadme ekraanil)

Tabel 3: Üldised sümbolid

## 2.1 Üldised ohutusjuhised

### 2.1.1 Kõik kodumasinad

#### **Liikuvatest osadest tingitud elektrilöögi oht!**

- Elektriliste osade remondil tehtud vead võivad põhjustada elektrilööki!
- Lahutage seade vooluvõrgust vähemalt 60 sekundit enne tööle hakkamist.
- Pärast remonti peab olema tehtud ohutuskatse vastavalt standardile VDE 0701 või riiklikele määrustele.

#### **Teravatest servadest tingitud vigastusoht!**

- Kandke kaitsekindaid.

#### **Rasketest ja liikuvatest osadest tingitud muljumisoht remondi-, puhastustööde, tõrkeotsingu ja hoolduse käigus**

- Kandke turvakingi.
- Kinnitage rasked osad allakukkumise vastu.
- Ärge toppige kehaosi liikuvate osade vahele.



#### **Oht seadme ohutusele/talitlusele!**

- Kasutage ainult originaalvaruosasid.

#### **Elektrostaatiliselt tundlike osade (ESD) kahjustamise oht!**

- Ärge puudutage moduleid, kaasa arvatud ühendusi ega transportöörlinte.

## Tööriistad ja abinõud

Määramine	Üksikasjad	Kujutised
Kaitseriie [00342013]	60 cm × 50 cm	
Tähtotsik TX20 [00340865]	6,3 mm (1/4 tolli)	
Eritööriist [00342180]		

## 4.1 Uksetihendi vahetamine

Nõue:

- ✓ Uks on lahti.

### 4.1.1 Uksetihendi eemaldamine

1. Vabastage uksetihend soonest paremast ja vasakust nurgast.

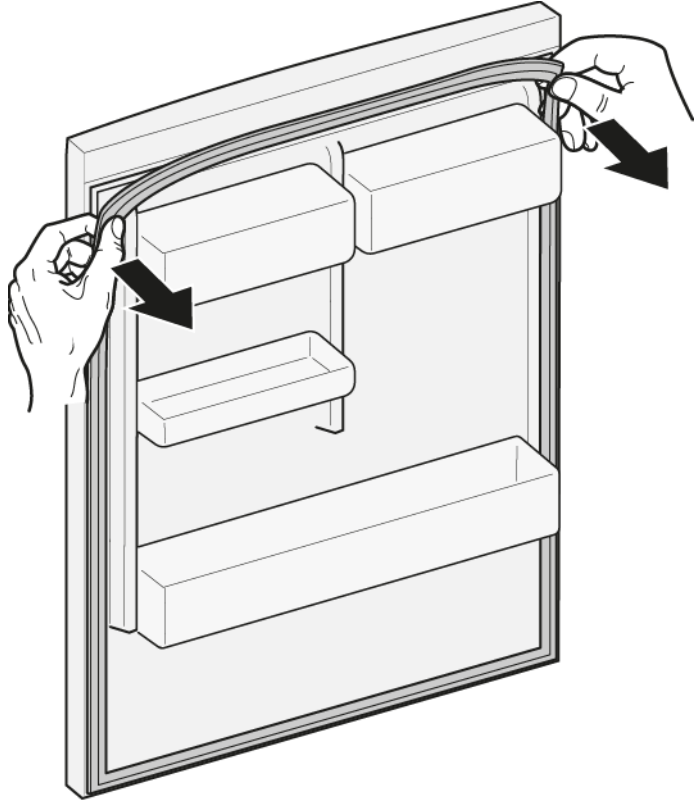

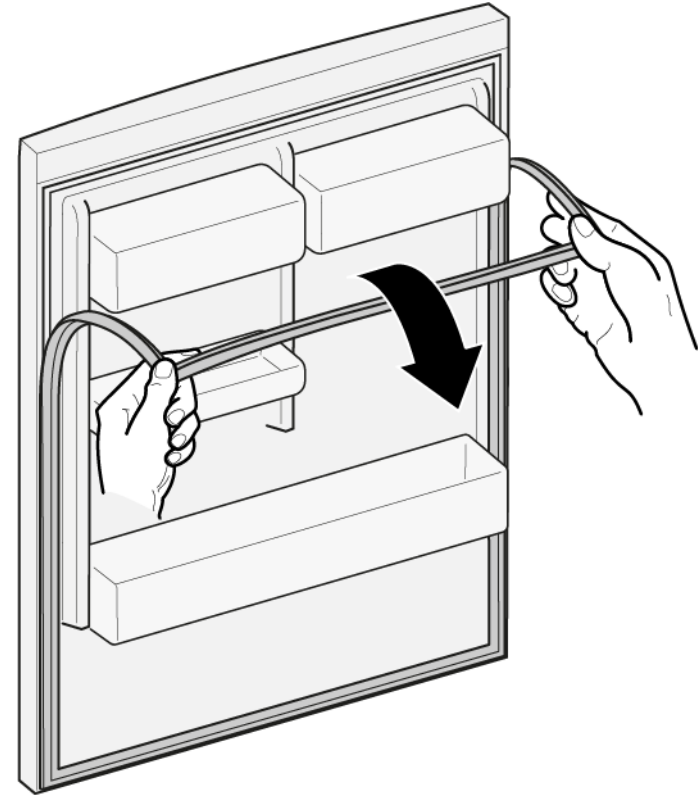

2. Tõmmake uksetihend soonest välja.



- ➡ Uksetihend on eemaldatud.

### 4.1.2 Uksetihendi paigaldamine

	Uue uksetihendi paksus võib veidi erineda vana tihendi paksusest. See ei mõjuta ukse sulgemist ja pikaajalist tööd.
	Kui teie seadmel on reguleeritavad hinged või hingekinnitused, saate sulgemismehhanismi hiljem sobivaks sättida.
	Väikesed augud uksetihendis on vajalikud õhutuseks. Need ei ole tootmisvead.

1. Kontrollige, kas tihendi soon on terve.

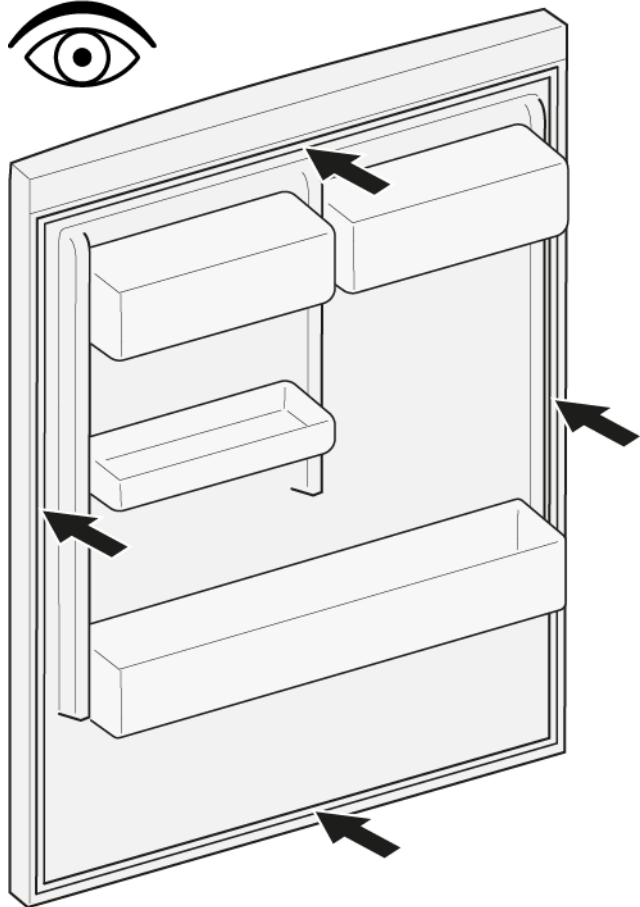

4. Lükake tihendi otsad soone üla- ja alanurka.

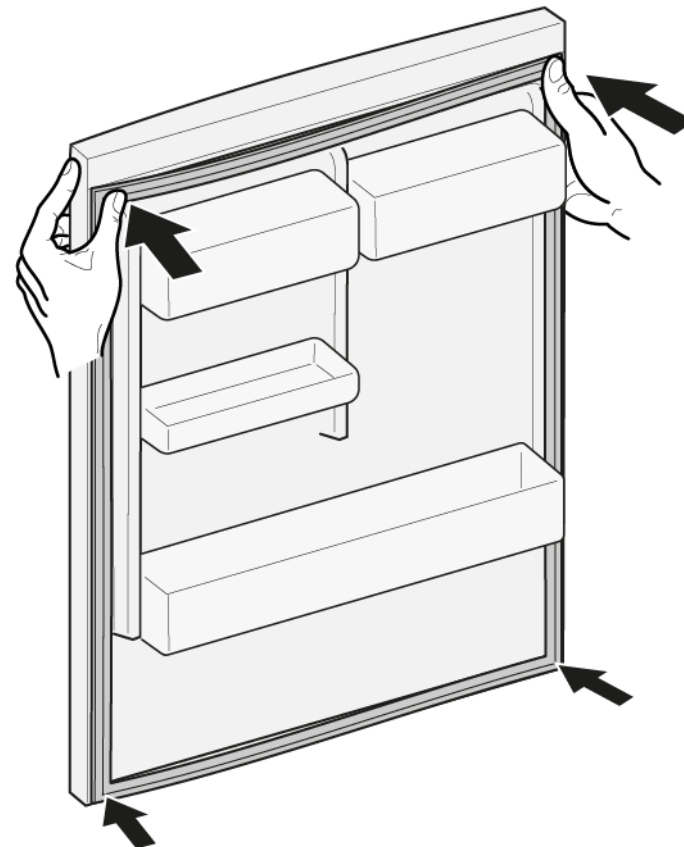

2. ⓘ Kui tihendi soon on kahjustatud,  
- pöörduge klienditeeninduse poole.

3. ⓘ Uksetihendi kerge kõverdumine on normaalne ega mõjuta selle toimivust. Soovitav on uksetihend enne seadmesse paigaldamist sirgu tõmmata.

Soojendage uksetihendit fööni või sooja veega ja vormige seda käsitsi.



5. Vajutage terve tihend jupphaaval soonde.

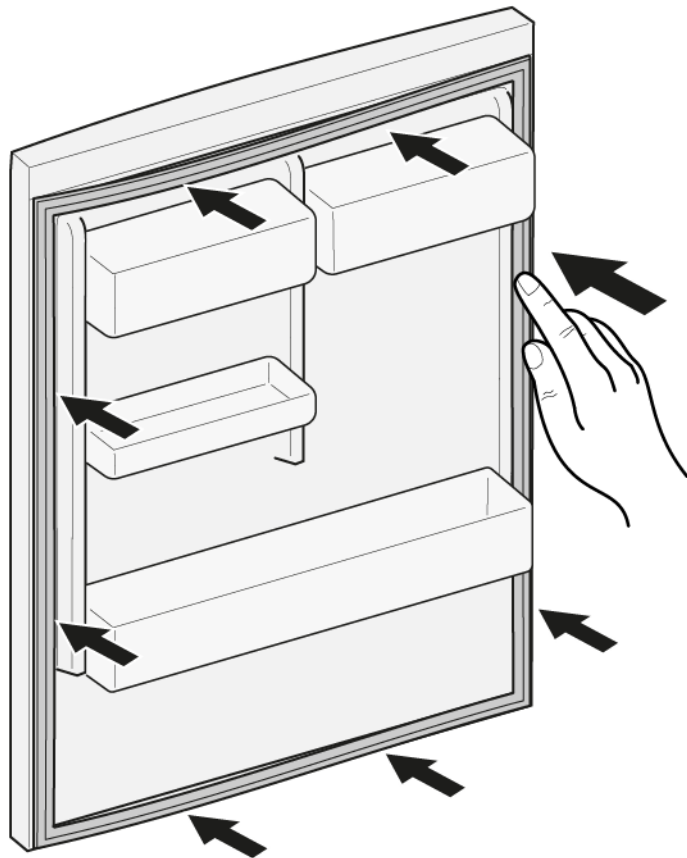

➡ Uksetihend on paigaldatud.

## 4.2 Tasapinnalise hinge vahetamine

### Eritööriistad:

Tähtotsik TX20

6,3 mm (1/4 tolli)

[00340865]



#### HOIATUS

##### Masked, kogukad seadmed!

Selja- ja lihasevigastused

- ▶ Seadme ust tohivad eemaldada vaid vastava väljaõppe saanud spetsialistid.
- ▶ Seadme liigutamiseks on vaja kaht inimest.
- ▶ Kasutage vaid sobivaid tööriistu ja varustust.



#### ETTEVAATUST!

##### Teravad servad!

Lõikehaavad

- ▶ Kandke kaitsekindaid.



#### ETTEVAATUST!

##### Avatud liigendi piirkond!

Sõrmede muljumine/kinnijäämine

- ▶ Ärge pistke käsi liigendi piirkonda.
- ▶ Kandke kaitsekindaid.



#### ETTEVAATUST!

##### Lahtikeeratud poltidest tingitud osade kukumisoht!

Kukkuvatest osadest tingitud vigastused.

- ▶ Kinnitage osa allakukkumise vastu.



#### TÄHELEPANU!

##### Lahtikeeratud poltidest tingitud osade kukumisoht!

Seadme teiste osade kahjustused või klientide vara kahjustused.

- ▶ Kinnitage osa allakukkumise vastu.

### Nõue:

- ✔ Seade on toitest lahutatud.
- ✔ Mööbliuks on eemaldatud. Vt paigaldusjuhiseid.
- ✔ Uks on lahti.

## 4.2.1 Tasapinnalise hinge eemaldamine

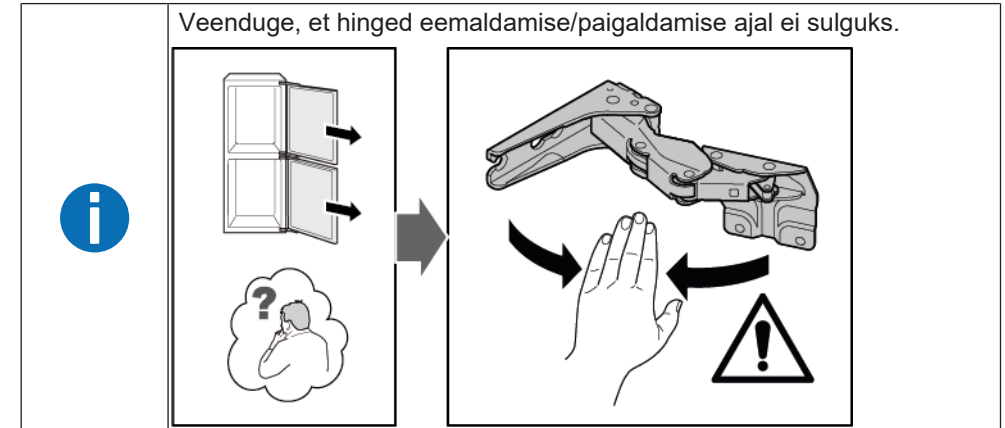

1. Eemaldage neli hinge katet.

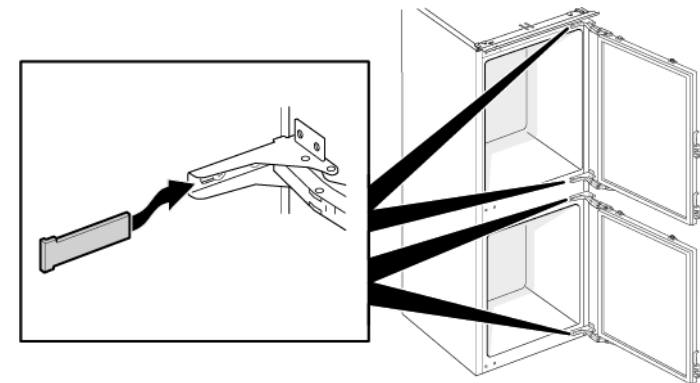

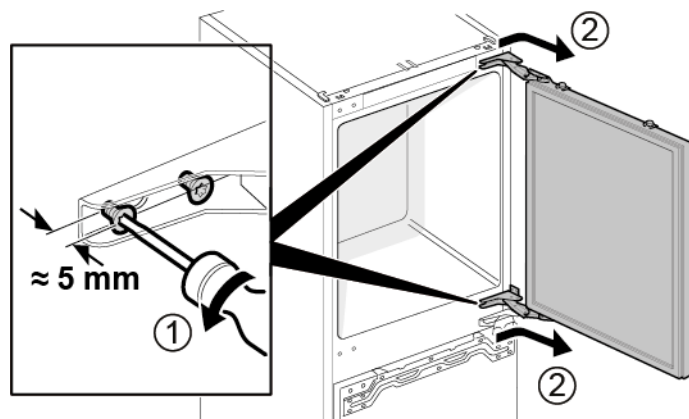

## Remont

2. 1. Keerake lahti neli kruvi (1).  
2. Libistage ülemine uks välja ja eemaldage see (2).

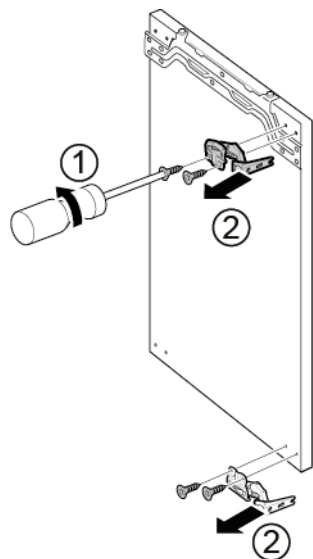

3. 1. Eemaldage neli kruvi (1).  
2. Eemaldage hinged (2).



 Ülemise ukse hinged on eemaldatud.

4. 1. Keerake lahti neli kruvi (1).  
2. Libistage alumine uks välja ja eemaldage see (2).

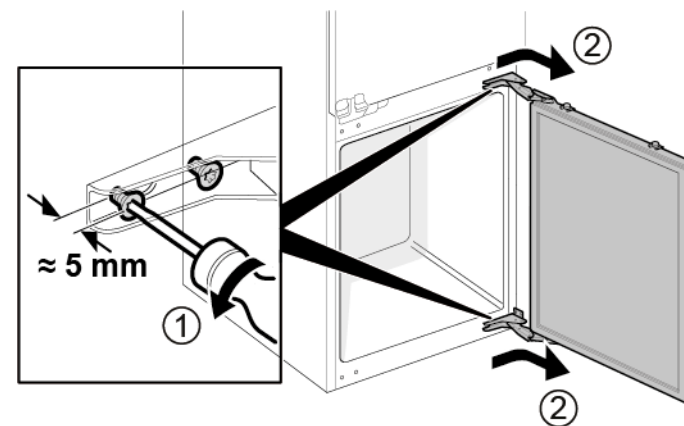

5. 1. Eemaldage neli kruvi (1).  
2. Eemaldage hinged (2).

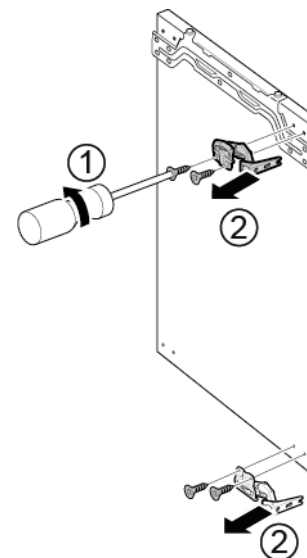

 Alumise ukse hinged on eemaldatud.

#### **4.2.2 Tasapinnalise hinge paigaldamine**

- ▶ Paigaldage vastupidises järjekorras.

## 4.3 Lükandhinge vahetamine

### Eritööriistad:

Tähtotsik TX20

6,3 mm (1/4 tolli)

[00340865]

	<p style="text-align: center;"><b>⚠ HOIATUS</b></p> <p><b>Masked, kogukad seadmed!</b> Selja- ja lihasevigastused</p> <ul style="list-style-type: none"> <li>▶ Seadme ust tohivad eemaldada vaid vastava väljaõppe saanud spetsialistid.</li> <li>▶ Seadme liigutamiseks on vaja kaht inimest.</li> <li>▶ Kasutage vaid sobivaid tööriistu ja varustust.</li> </ul>
	<p style="text-align: center;"><b>⚠ ETTEVAATUST!</b></p> <p><b>Teravad servad!</b> Lõikehaavad</p> <ul style="list-style-type: none"> <li>▶ Kandke kaitsekindaid.</li> </ul>
	<p style="text-align: center;"><b>⚠ ETTEVAATUST!</b></p> <p><b>Lahtikeeratud poltidest tingitud osade kukkumisoht!</b> Kukkuvatest osadest tingitud vigastused.</p> <ul style="list-style-type: none"> <li>▶ Kinnitage osa allakukkumise vastu.</li> </ul>
	<p style="text-align: center;"><b>TÄHELEPANU!</b></p> <p><b>Lahtikeeratud poltidest tingitud osade kukkumisoht!</b> Seadme teiste osade kahjustused või klientide vara kahjustused.</p> <ul style="list-style-type: none"> <li>▶ Kinnitage osa allakukkumise vastu.</li> </ul>

### Nõue:

- ✔ Seade on toitest lahutatud.
- ✔ Mööbliuks ja seadme uks on eraldatud. Vt paigaldusjuhiseid.

## 4.3.1 Lükandhinge eemaldamine

1. Keerake lahti kaks kruvi (1).
2. Eemaldage ülemise ukse ülemine hing (2).
3. Eemaldage ülemine uks (3).
4. Keerake lahti kaks kruvi (4).
5. Eemaldage alumise ukse ülemine hing (5).
6. Eemaldage alumine uks (6).

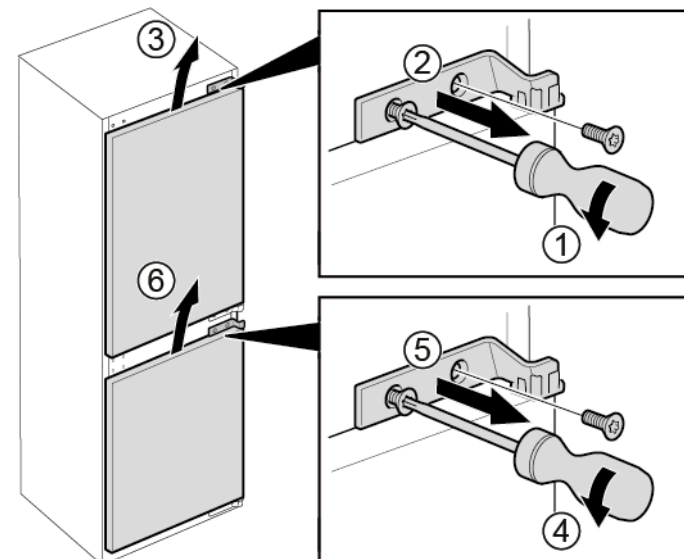

2. 1. Eemaldage neli kruvi (1).
2. Eemaldage alumised hinged (2).

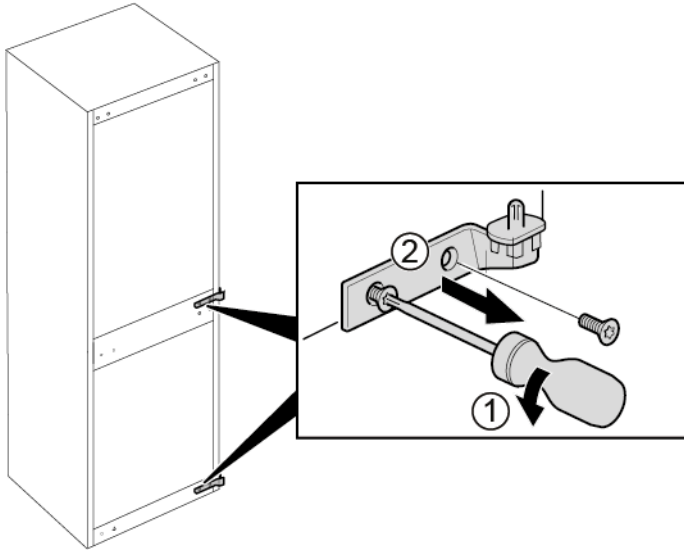

➡ Hinged on eemaldatud.

#### 4.3.2 Lükandhinge paigaldamine

- ▶ Paigaldage vastupidises järjekorras.

## 4.4 Ukseraami vahetamine

Nõue:

- ✓ Uks on lahti.

### 4.4.1 Ukseraami eemaldamine

- ▶ Tõstke ukseraam üles.

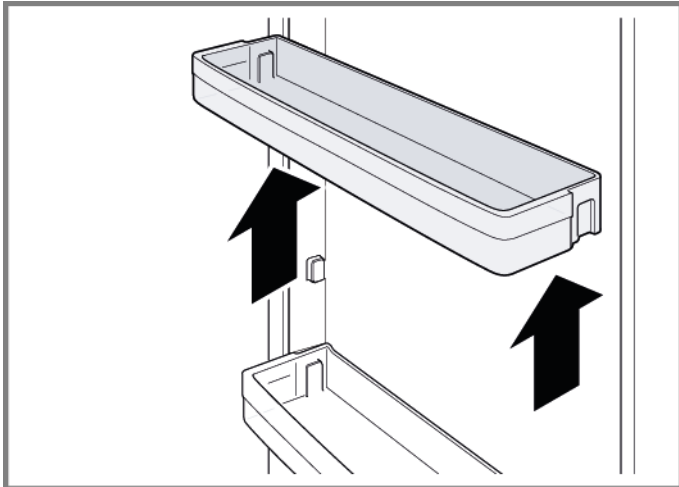

➡ Ukseraam on eemaldatud.

### 4.4.2 Ukseraami paigaldamine

- ▶ Paigaldage vastupidises järjekorras.

## 4.5 Riiuli vahetamine

Nõue:

- ✔ Uks on lahti.

### 4.5.1 Riiuli eemaldamine

- ▶ Tõmmake riiul välja.

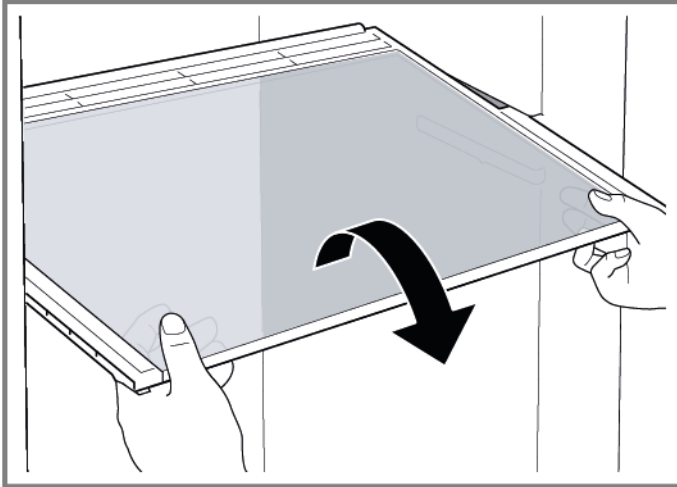

➡ Riiul on eemaldatud.

### 4.5.2 Riiuli paigaldamine

- ▶ Paigaldage vastupidises järjekorras.



## 4.6 Laiendatava riuli vahetamine

Nõue:

- ✔ Uks on lahti.

### 4.6.1 Laiendatava riuli eemaldamine

1. Tõmmake laiendatavat riulit välja, kuni lukustuskonks tuleb lahti.

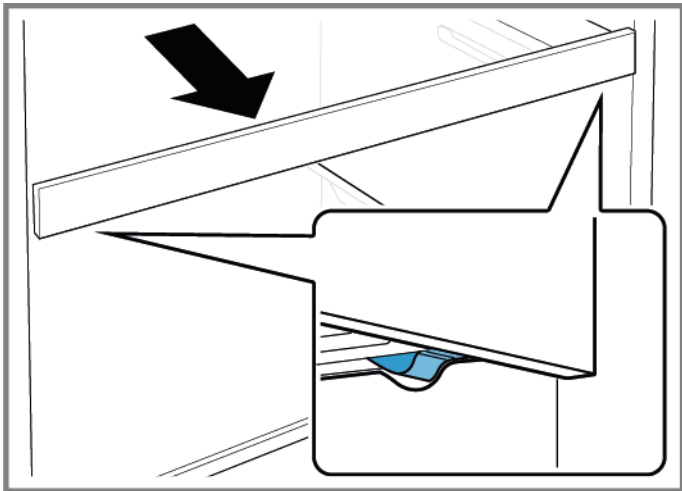

2. Laske laiendatavat riulit madalamale ja keerake see küljele.
3. ⬅ Laiendatav riul on eemaldatud.

### 4.6.2 Laiendatava riuli paigaldamine

- ▶ Paigaldage vastupidises järjekorras.

## 4.7 Sügavkülmikuosa riuli vahetamine

Nõue:

- ✓ Uks on lahti.

### 4.7.1 Sügavkülmikuosa riuli eemaldamine

- ▶ Tõmmake sügavkülmikuosa riul välja.

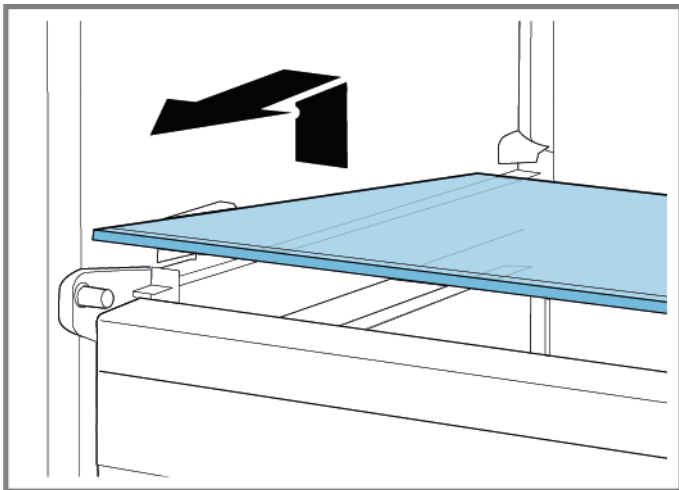

- ➡ Sügavkülmikuosa riul on eemaldatud.

### 4.7.2 Sügavkülmikuosa riuli paigaldamine

- ▶ Paigaldage vastupidises järjekorras.

## 4.8 Külmutatud toidu mahuti vahetamine

Nõue:

- ✓ Uks on lahti.

### 4.8.1 Külmutatud toidu mahuti eemaldamine

- ▶ 1. Tõmmake külmutatud toidu mahuti täielikult välja (1).
- ▶ 2. Eemaldage külmutatud toidu mahuti (2).

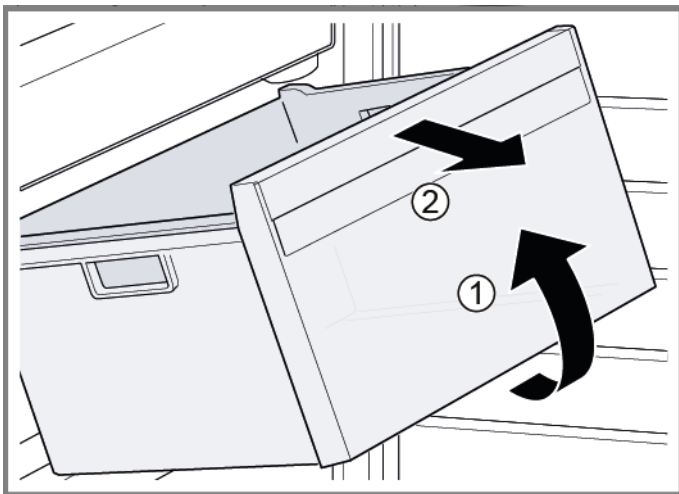

- ➡ Külmutatud toidu mahuti on eemaldatud.

### 4.8.2 Külmutatud toidu mahuti paigaldamine

- ▶ Paigaldage vastupidises järjekorras.

## 4.9 Puu- ja köögiviljamahuti vahetamine

Nõue:

- ✓ Uks on lahti.

### 4.9.1 Puu- ja köögiviljamahuti eemaldamine

- ▶ 1. Tõmmake mahuti täielikult välja (1).
- ▶ 2. Eemaldage mahuti (2).

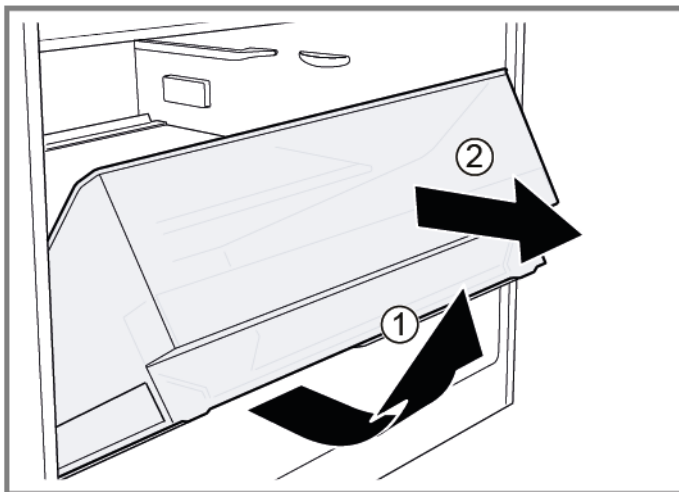

- ➡ Mahuti on eemaldatud.

### 4.9.2 Puu- ja köögiviljamahuti paigaldamine

- ▶ Paigaldage vastupidises järjekorras.

## 4.10 Puu- ja köögiviljamahuti vaheseina ja katte vahetamine

Nõue:

- ✓ Uks on lahti.

### 4.10.1 Puu- ja köögiviljamahuti vaheseina ja katte eemaldamine

1. Eemaldage vaheseinalt klaasplaat.

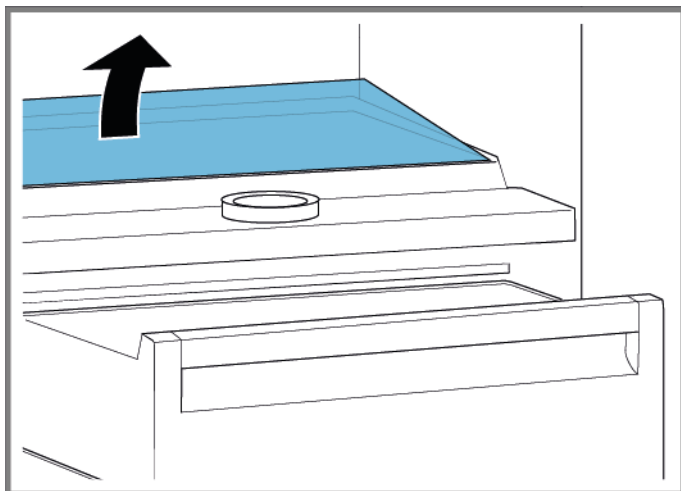

2. [Eemaldage puu- ja köögiviljamahuti.](#) → 164

3. 1. Vajutage kangi kummalgi pool vaheseina alaosa (1).
2. Tõmmake vaheseina ettepoole (2).

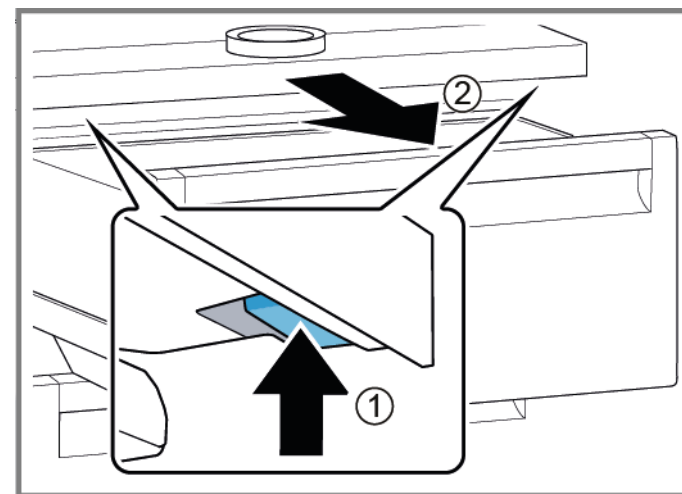

4. Tõstke vaheseina ja pöörake see külgepidi välja.  
➡ Vahesein on eemaldatud.
5. 1. Tõstke puu- ja köögiviljamahuti kate üles.  
2. Tõmmake puu- ja köögiviljamahuti katet ettepoole ja pöörake see külgepidi välja.  
➡ Puu- ja köögiviljamahuti kate on eemaldatud.

### 4.10.2 Puu- ja köögiviljamahuti vaheseina ja katte paigaldamine

- ▶ Paigaldage vastupidises järjekorras.

## 4.11 Jahutusmahuti vahetamine

Nõue:

- ✓ Uks on lahti.

### 4.11.1 Jahutusmahuti eemaldamine

- ▶ 1. Kallutage jahutusmahutit ettepoole (1).
- ▶ 2. Eemaldage jahutusmahuti (2).

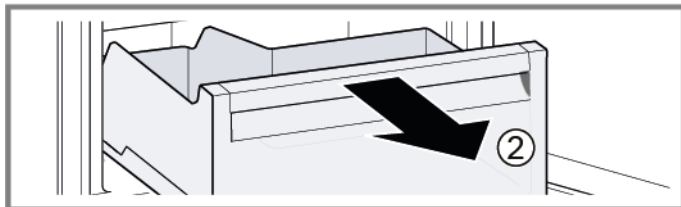
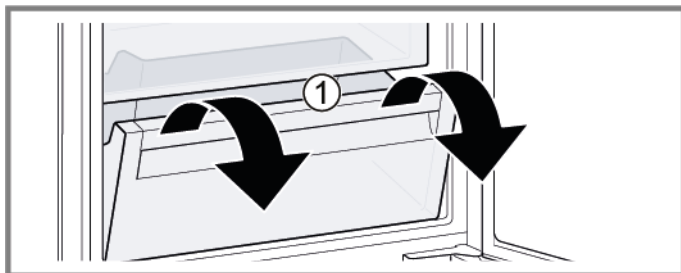

➡ Jahutusmahuti on eemaldatud.

### 4.11.2 Jahutusmahuti paigaldamine

- ▶ Paigaldage vastupidises järjekorras.

## 4.12 Laiendatava mahuti vahetamine

Nõue:

- ✓ Uks on lahti.

### 4.12.1 Laiendatava mahuti eemaldamine

- ▶ 1. Kallutage laiendatavat mahutit ettepoole (1).
- ▶ 2. Eemaldage laiendatav mahuti (2).

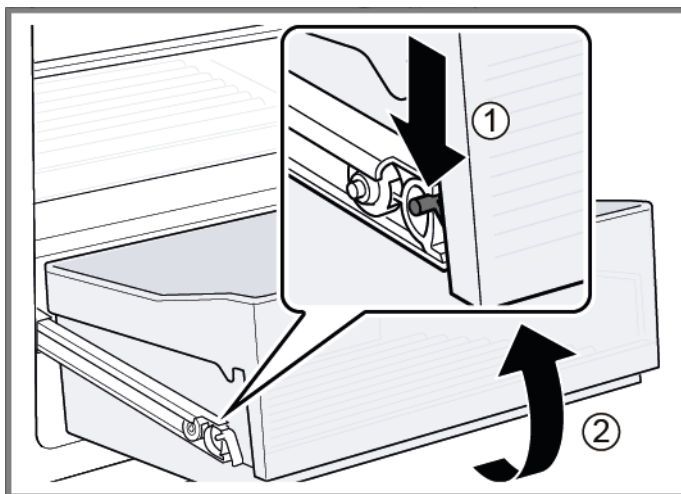



➡ Laiendatav mahuti on eemaldatud.

### 4.12.2 Laiendatava mahuti paigaldamine

- ▶ Paigaldage vastupidises järjekorras.

## 4.13 LED-kohtvalgusti vahetamine

### Eritööriistad:

-  Eritööriist [00342180]
-  Lapik kruvikeeraja Tera 2,4 mm × 0,4 mm × 60 mm, komplektis [00341820]



 Teie seadmel on LED-tuli, mis ei vaja hooldust. Seda tuld tohib parandada ainult klienditeenindus või volitatud tehnik!

 **OHT**  
**Liikuvatest osadest tingitud elektrilöögi oht!**  
 Kui remonditööd on valesti tehtud, esineb elektrilöögist tingitud eluoht.  
 ▶ Elektrilisi osasid peavad parandama kvalifitseeritud elektrikud.  
 ▶ Pärast remonti peab olema tehtud ohutuskatse vastavalt standardile VDE 0701 või riiklikele määrustele.

 **OHT**  
**Liikuvatest osadest tingitud elektrilöögi oht!**  
 Elektrilöögist tingitud surm  
 ▶ Enne remonditöödega alustamist ühendage seadmed elektrivõrgust lahti vähemalt 60 sekundit varem.

 **ETTEVAATUST!**  
**Teravad servad!**  
 Lõikehaavad  
 ▶ Kandke kaitsekindaid.

### Nõue:

-  Seade on toitest lahutatud.
-  Uks on lahti.
-  Külmiakuosa riulid on eemaldatud.

## 4.13.1 LED-kohtvalgusti eemaldamine

1. Vabastage LED-kohtvalgusti kate.

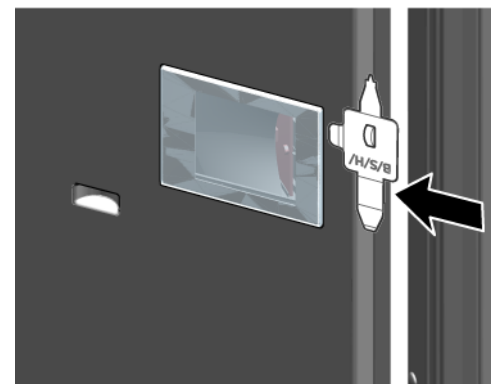

2. Tõmmake LED-kohtvalgusti katet sissepoole ja lükake seda samal ajal edasi.

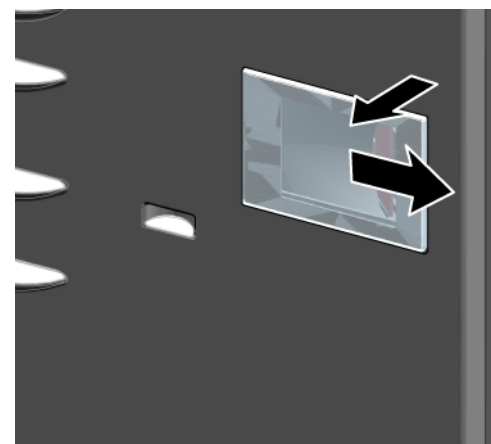



3. Eemaldage LED-kohtvalgusti moodul.

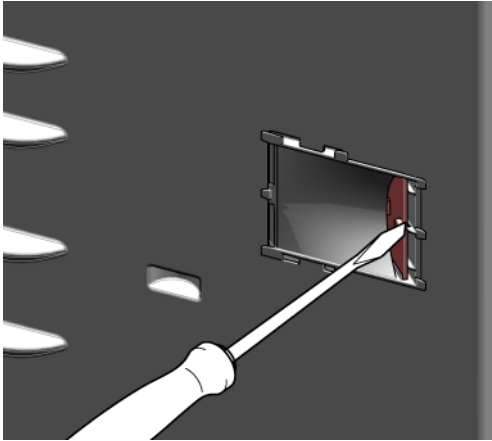

4. Lahutage LED-kohtvalgusti elektrühendus.

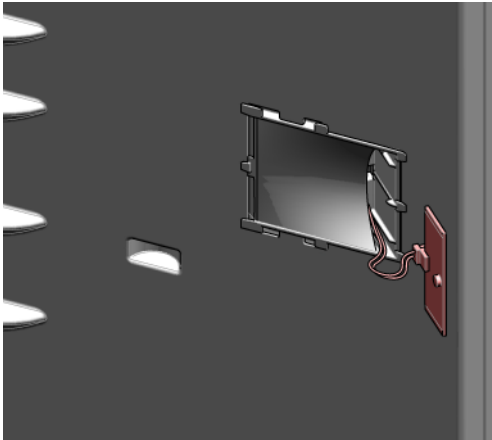



➡ LED-kohtvalgusti on eemaldatud.

## 4.13.2 LED-kohtvalgusti paigaldamine

- ▶ Paigaldage vastupidises järjekorras.

# Korjausvinkit - Jääkaappipakastin

 <b>Tämä asiakirja</b> .....	<b>171</b>
1.1 Tärkeitä tietoja.....	171
1.1.1 Tarkoitus .....	171
1.2 Symboleiden merkitys.....	171
1.2.1 Vaaratasot.....	171
1.2.2 Varoitusmerkit.....	171
1.2.3 Varoitusten rakenne .....	172
1.2.4 Yleiset symbolit.....	172
 <b>Turvallisuus</b> .....	<b>173</b>
2.1 Yleiset turvallisuusohjeet.....	173
2.1.1 Kaikki kotitalouskoneet.....	173
 <b>Työkalut ja apuvälineet</b> .....	<b>174</b>
 <b>Korjaus</b> .....	<b>175</b>
4.1 Oven tiivisteen vaihtaminen.....	175
4.1.1 Oven tiivisteen poistaminen .....	175
4.1.2 Oven tiivisteen asennus .....	175
4.2 Litteän saranan vaihtaminen .....	178
4.2.1 Litteän saranan poistaminen .....	178
4.2.2 Litteän saranan asennus .....	180
4.3 Liukusaranan vaihtaminen .....	181
4.3.1 Liukusaranan poistaminen .....	181
4.3.2 Liukusaranan asennus .....	182
4.4 Ovihyllyn vaihtaminen .....	183
4.4.1 Ovihyllyn poistaminen .....	183
4.4.2 Ovihyllyn asennus .....	183
4.5 Hyllyn vaihtaminen .....	184
4.5.1 Hyllyn poistaminen .....	184
4.5.2 Hyllyn asennus .....	184
4.6 Ulosvedettävän hyllyn vaihtaminen .....	185
4.6.1 Ulosvedettävän hyllyn poistaminen .....	185
4.6.2 Ulosvedettävän hyllyn asennus .....	185
4.7 Pakastinosan hyllyn vaihtaminen .....	186
4.7.1 Pakastinosan hyllyn poistaminen .....	186
4.7.2 Pakastinosan hyllyn asennus .....	186

4.8 Pakastelokeron vaihtaminen .....	187
4.8.1 Pakastelokeron poistaminen .....	187
4.8.2 Pakastelokeron asennus .....	187
4.9 Hedelmä- ja vihanneslokeron vaihtaminen.....	188
4.9.1 Hedelmä- ja vihanneslokeron poistaminen .....	188
4.9.2 Hedelmä- ja vihanneslokeron asennus .....	188
4.10 Hedelmä- ja vihanneslokeron välilevyn ja suojuksen vaihtaminen .....	189
4.10.1 Hedelmä- ja vihanneslokeron välilevyn ja suojuksen poistaminen.....	189
4.10.2 Hedelmä- ja vihanneslokeron välilevyn ja suojuksen asennus .....	189
4.11 Cool-fresh-lokeron vaihtaminen .....	190
4.11.1 Cool-fresh-lokeron poistaminen .....	190
4.11.2 Cool-fresh-lokeron asennus .....	190
4.12 Ulosvedettävän lokeron vaihtaminen .....	191
4.12.1 Ulosvedettävän lokeron poistaminen .....	191
4.12.2 Ulosvedettävän lokeron asennus .....	191
4.13 LED-kohdevalon vaihtaminen .....	192
4.13.1 LED-kohdevalon poistaminen.....	192
4.13.2 LED-kohdevalon asennus .....	193

# Tämä asiakirja

## 1.1 Tärkeitä tietoja

### 1.1.1 Tarkoitus

Näiden korjausohjeiden tarkoituksena on auttaa kuluttajaa korjaamaan laitteita itse ekologista suunnittelua koskevan asetuksen (päivitys 03/2021) mukaisesti.



Ne sisältävät tietoja siitä, miten määrätyt varaosat voidaan vaihtaa. Lisäksi niihin sisältyy tietoja varoituksista ja riskeistä.

Ota yhteyttä huoltopalveluun, jos sinulla on kysyttävää. Vastamme vahingoista vain, jos korjausohjeita on noudatettu oikein.

## 1.2 Symboleiden merkitys

### 1.2.1 Vaaratasot

Varoitustasot koostuvat symbolista ja huomiosanasta. Huomiosanat ilmoittava vaaran vakavuuden.

Varoitustaso	Merkitys
 <b>VAARA</b>	Varoituksen laiminlyönti johtaa kuolemaan tai vakaviin loukkaantumisiin.
 <b>VAROITUS</b>	Varoituksen laiminlyönti voi johtaa kuolemaan tai vakaviin loukkaantumisiin.
 <b>HUOMAA</b>	Varoituksen laiminlyönti voi johtaa lieviin loukkaantumisiin.
<b>HUOMIO!</b>	Varoituksen laiminlyönti voi johtaa omaisuusvahinkoihin.

Taulukko 1: Vaaratasot

### 1.2.2 Varoitusmerkit

Varoitusmerkit ovat symboleita sisältäviä esityksiä, jotka osoittavat vaaran tyyppin.

Tässä asiakirjassa käytetään seuraavia varoitusmerkkejä:

Varoitusmerkki	Merkitys
	Yleinen varoitus
	Sähköjännitteestä aiheutuva vaara
	Räjähdysvaara
	Viiltohaavojen vaara
	Murskautumisen vaara

# Tämä asiakirja

Varoitusmerkki	Merkitys
	Kuumista pinnoista aiheutuva vaara
	Voimakkaasta magneettikentästä aiheutuva vaara
	Ionisoimattomasta säteilystä aiheutuva vaara



Taulukko 2: Varoitusmerkit

## 1.2.3 Varoitusten rakenne

Tämän asiakirjan sisältämällä varoituksilla on standardoitu ulkonäkö ja rakenne.



	<div style="background-color: red; color: white; padding: 2px; text-align: center;"> <b>VAARA</b></div> <p><b>Vaaran tyyppi ja lähde!</b> Vaaran/varoituksen laiminlyönnistä mahdollisesti aiheutuvat seuraukset.</p> <ul style="list-style-type: none"><li>▶ Vaaran ehkäisemiseen liittyvät toimenpiteet ja kiellot.</li></ul>
--	--

Seuraavassa esimerkissä näytetään varoitus, joka varoittaa jännitteisten osien aiheuttamasta sähköiskusta. Vaaran välttämiseksi suoritettava toimenpide mainitaan.

	<div style="background-color: red; color: white; padding: 2px; text-align: center;"> <b>VAARA</b></div> <p><b>Jännitteisten osien aiheuttama sähköiskun vaara!</b> Sähköiskun aiheuttama kuolema</p> <ul style="list-style-type: none"><li>▶ Erotta laitteet sähkövirrasta vähintään 60 sekuntia ennen korjaustöiden aloittamista.</li></ul>
---	---

## 1.2.4 Yleiset symbolit

Tässä asiakirjassa käytetään seuraavia yleisiä symboleja:

Yl. symboli	Merkitys
	Erikoisohjeen tunniste (teksti ja/tai kaavio)
	Yksinkertaisen ohjeen tunniste (vain teksti)

Yl. symboli	Merkitys
	Video-opetusohjelmaan johtavan linkin tunniste
	Tarvittavien työkalujen tunniste
	Tarvittavien edellytysten tunniste
	Ehdon (jos ..., sitten ...) tunniste
	Tuloksen tunniste
<u>Käynnistä</u>	Näppäimen tai painikkeen tunniste
[00123456]	Materiaalinumeron tunniste
Tila	Näytetyn tekstin/ikkunan (laitteen näytössä) tunniste

Taulukko 3: Yleiset symbolit

## 2.1 Yleiset turvallisuusohjeet

### 2.1.1 Kaikki kotitalouskoneet

#### Jännitteisten osien aiheuttama sähköiskun vaara!

- Virheet sähkökomponentteja sisältävissä korjauksissa voivat johtaa sähköiskuun!
- Kytke kone irti verkkovirrasta vähintään 60 sekuntia ennen töiden aloittamista.
- Pyydä korjauksen jälkeen suorittamaan VDE 0701 -säädöksen tai maakohtaisten säädösten mukainen turvallisuustesti.

#### Terävistä reunoista aiheutuva loukkaantumisvaara!

- Käytä suojakäsineitä.

#### Painavista ja liikkuvista komponenteista aiheutuva murskautumisen riski korjauksen, kunnossapidon, vianetsinnän ja huollon aikana

- Käytä suojakenkiä.
- Estä painavien komponenttien putoaminen.
- Älä koske liikkuviin komponentteihin.



#### Laitteen turvallisuudelle/toiminnalle aiheutuva riski!

- Käytä vain alkuperäisiä varaosia.

#### Staattiselle sähkölle herkkien komponenttien (ESDS) vaurioitumisen riski!

- Älä koske moduuleihin, liitännät ja johdinreitit mukaan luettuna.

## Työkalut ja apuvälineet

Nimitys	Yksityiskohdat	Kuvat
Suojapeite [00342013]	60 cm x 50 cm	
Torx-kärki TX20 [00340865]	6,3 mm (1/4")	
Erikoistyökalu [00342180]		

## 4.1 Oven tiivisteiden vaihtaminen

### Vaatus:

- ✓ Ovi on auki.

### 4.1.1 Oven tiivisteiden poistaminen

1. Irrota oven tiiviste urasta oikeassa ja vasemmassa nurkassa.

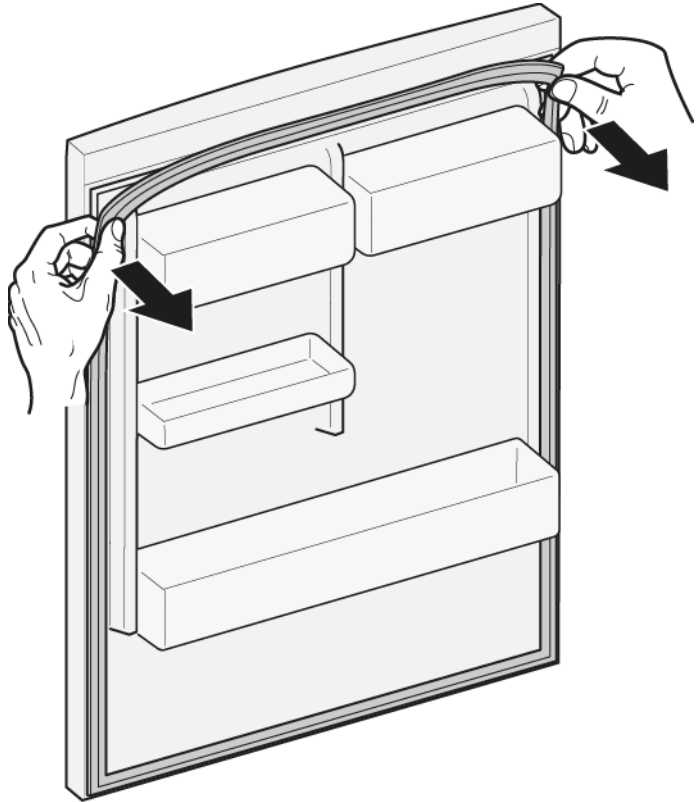

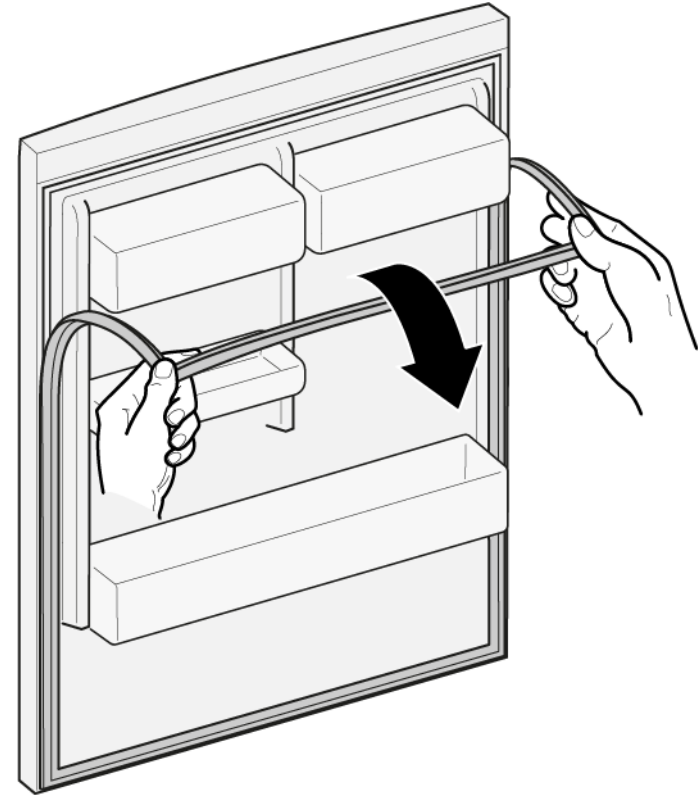

2. Vedä oven tiiviste ulos urasta.



- ➡ Oven tiiviste on poistettu.

### 4.1.2 Oven tiivisteiden asennus

	Uuden tiivisteiden paksuus voi poiketa hieman vanhan tiivisteiden paksuudesta. Sillä ei ole vaikutusta oven sulkeutumiseen eikä pitkän aikavälin toimintaan.
	Jos laitteessa on säädettävät saranat tai saranan kiinnittimet, voit optimoida sulkeutumista myöhemmin.
	Oven tiivisteiden sivuilla olevat pienet reiät ovat toiminnollisia (tarvitaan ilmanvaihtoa varten). Ne eivät ole tuotantovirheitä.

1. Tarkista, että tiivistettä varten oleva ura ei ole vioittunut.

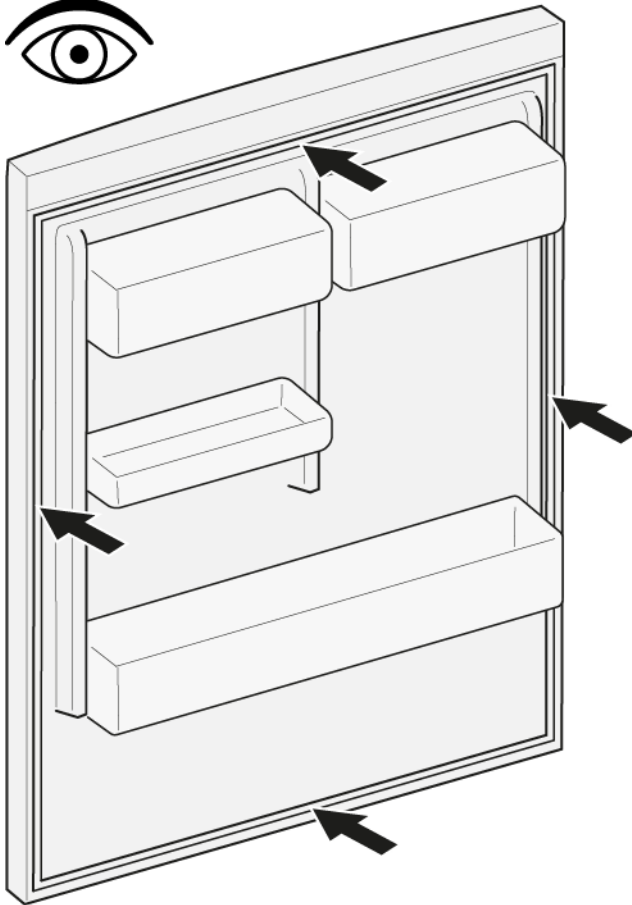

4. Työnnä tiivisteet nurkat ylhäällä ja alhaalla uraan.

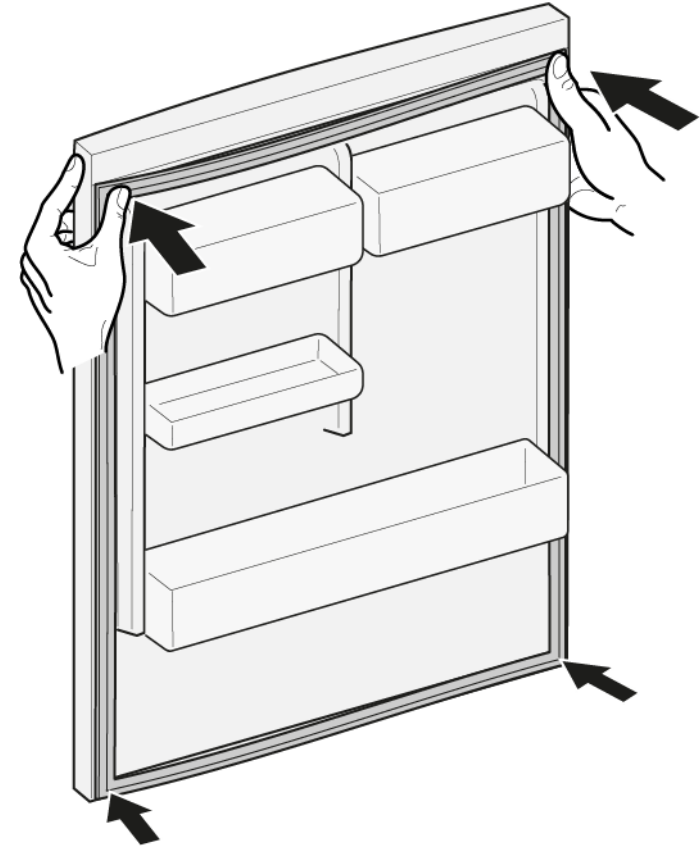

2.  Jos tiivisteiden ura on vioittunut.  
- Ota yhteyttä asiakaspalveluun.

3.  Oven tiivisteiden pienet vääntymät ovat normaaleja eikä niillä ole vaikutusta sen toimintaan. Oven tiiviste kannattaa suoristaa, ennen kuin se asetetaan laitteeseen.

Kuumenna oven tiivistettä hiustenkuivaajalle tai kuumalla vedellä ja muotoile se käsin uudelleen.



5. Paina koko tiiviste vähitellen uraan.

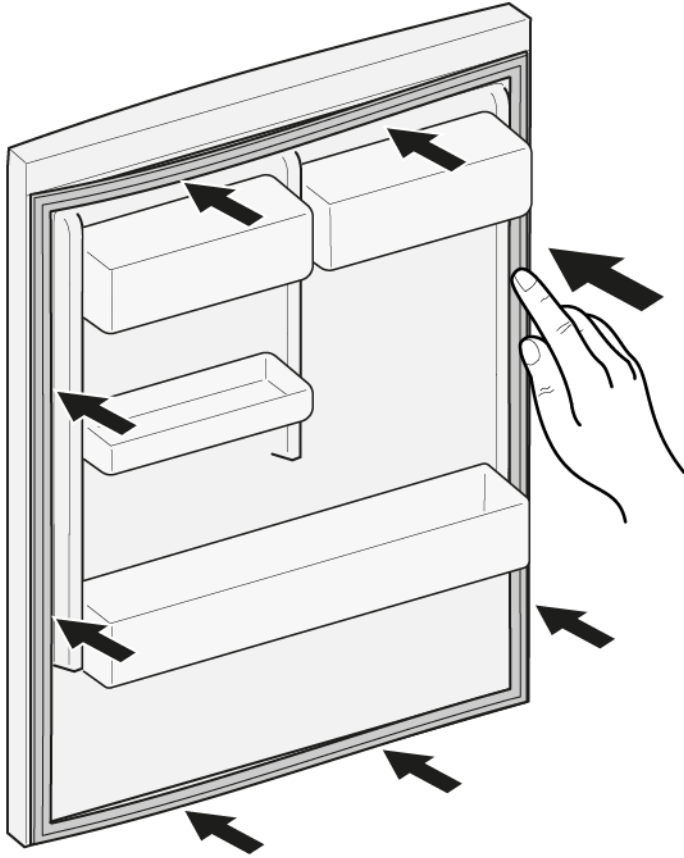

 Oven tiiviste on asennettu.

## 4.2 Litteän saranan vaihtaminen

### Erikoistyökalut:

Torx-kärki TX20

6,3 mm (1/4")

[00340865]



#### VAROITUS

##### Painavat, isokokoiset laitteet!

Selän ja lihasten vammat

- ▶ Vain koulutettujen ammattilaisten tulisi suorittaa laitteen oven poistamiseen liittyvät vaiheet.
- ▶ Laitteen siirtämiseen tarvitaan kahta ihmistä.
- ▶ Käytä vain soveltuvia työkaluja ja välineitä.



#### HUOMAA

##### Terävät reunat!

Viiltovammat

- ▶ Käytä suojakäsineitä.



#### HUOMAA

##### Avoin saranan alue!

Sormien murskautuminen / jääminen väliin

- ▶ Älä koske saranan alueelle.
- ▶ Käytä suojakäsineitä.



#### HUOMAA

##### Ruuvien avaamisesta aiheutuva osien putoamisen riski!

Loukkaantuminen putoavien osien vuoksi.

- ▶ Estä komponentin putoaminen.



#### HUOMIO!

##### Ruuvien avaamisesta aiheutuva osien putoamisen riski!

Vauriot koneen muille osille tai asiakkaan kodille, esim. lattia.

- ▶ Estä komponentin putoaminen.

### Vaatus:

- ✓ Kone on erotettu tehollähteestä.
- ✓ Kalusteovi on poistettu. Katso Asennusohjeet.
- ✓ Ovi on auki.

## 4.2.1 Litteän saranan poistaminen

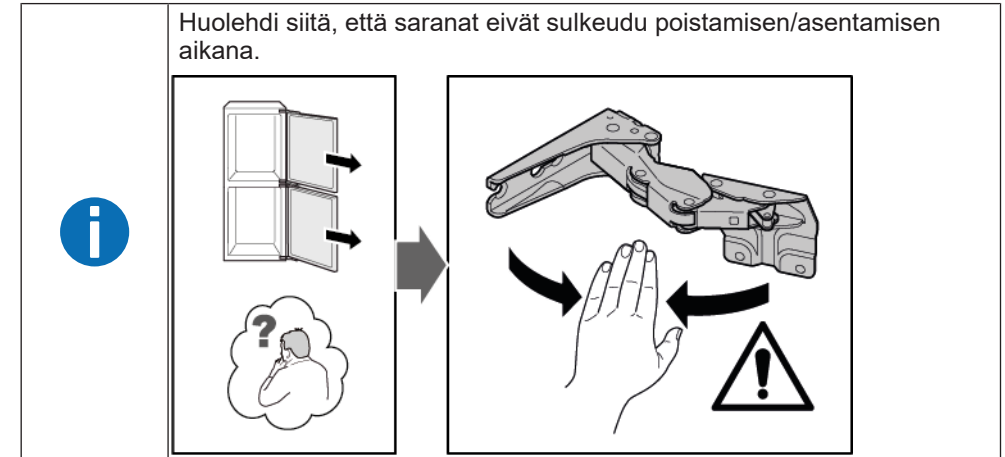

1. Poista neljä saranan suojusta.

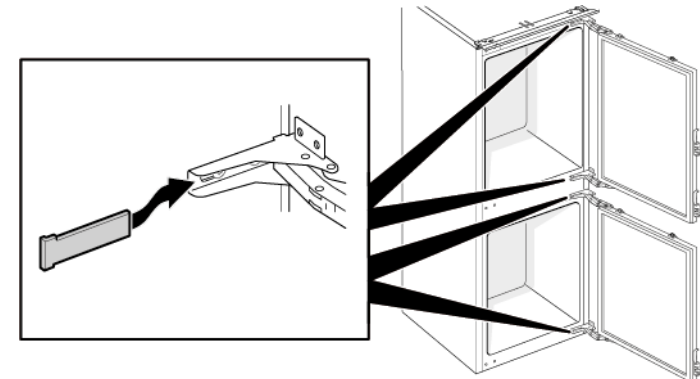

## Korjaus

2. 1. Löysää neljä ruuvia (1).  
2. Liu'uta ylempi ovi ulos ja poista se (2).

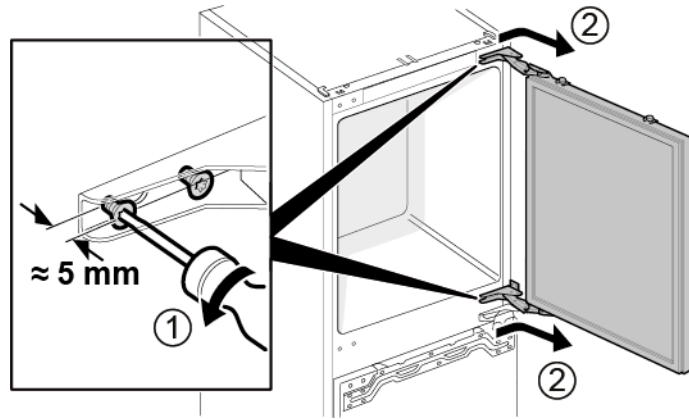

3. 1. Poista neljä ruuvia (1).  
2. Poista saranat (2).

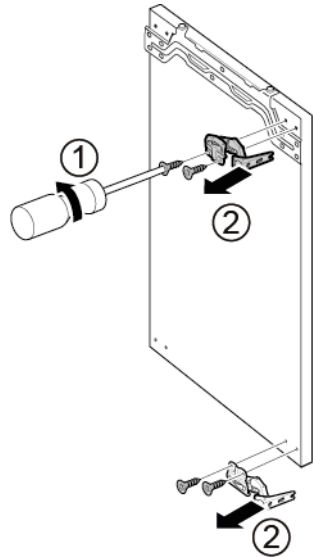

 Ylemmän oven saranat on poistettu.

4. 1. Löysää neljä ruuvia (1).  
2. Liu'uta alempi ovi ulos ja poista se (2).

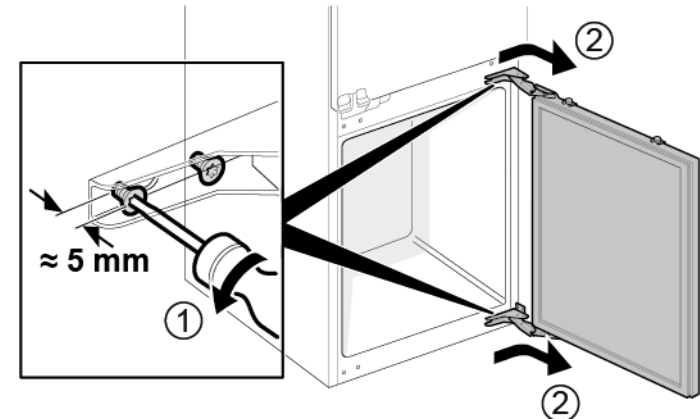

5. 1. Poista neljä ruuvia (1).  
2. Poista saranat (2).

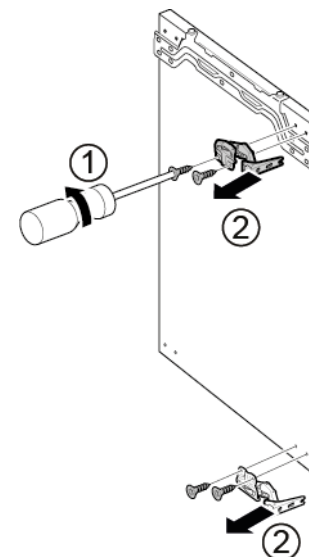

 Alemman oven saranat on poistettu.





#### **4.2.2 Litteän saranan asennus**

- ▶ Asenna vastakkaisessa järjestyksessä.

## 4.3 Liukusaranan vaihtaminen

### Erikoistyökalut:

Torx-kärki TX20 6,3 mm (1/4") [00340865]

	<p style="text-align: center;"><b>VAROITUS</b></p> <p><b>Painavat, isokokoiset laitteet!</b> Selän ja lihasten vammat</p> <ul style="list-style-type: none"> <li>▶ Vain koulutettujen ammattilaisten tulisi suorittaa laitteen oven poistamiseen liittyvät vaiheet.</li> <li>▶ Laitteen siirtämiseen tarvitaan kahta ihmistä.</li> <li>▶ Käytä vain soveltuvia työkaluja ja välineitä.</li> </ul>
	<p style="text-align: center;"><b>HUOMAA</b></p> <p><b>Terävät reunat!</b> Viiltovammat</p> <ul style="list-style-type: none"> <li>▶ Käytä suojakäsineitä.</li> </ul>
	<p style="text-align: center;"><b>HUOMAA</b></p> <p><b>Ruuvien avaamisesta aiheutuva osien putoamisen riski!</b> Loukkaantuminen putoavien osien vuoksi.</p> <ul style="list-style-type: none"> <li>▶ Estä komponentin putoaminen.</li> </ul>
	<p style="text-align: center;"><b>HUOMIO!</b></p> <p><b>Ruuvien avaamisesta aiheutuva osien putoamisen riski!</b> Vauriot koneen muille osille tai asiakkaan kodille, esim. lattia.</p> <ul style="list-style-type: none"> <li>▶ Estä komponentin putoaminen.</li> </ul>

### Vaatus:

- ✓ Kone on erotettu teholahteesta.
- ✓ Kalusteovi ja laitteen ovi on erotettu toisistaan. Katso Asennusohjeet.

## 4.3.1 Liukusaranan poistaminen

1. Kierrä kaksi ruuvia auki (1).
2. Poista ylemmän oven yläsarana (2).
3. Poista ylempi ovi (3).
4. Kierrä kaksi ruuvia auki (4).
5. Poista alemman oven yläsarana (5).
6. Poista alempi ovi (6).

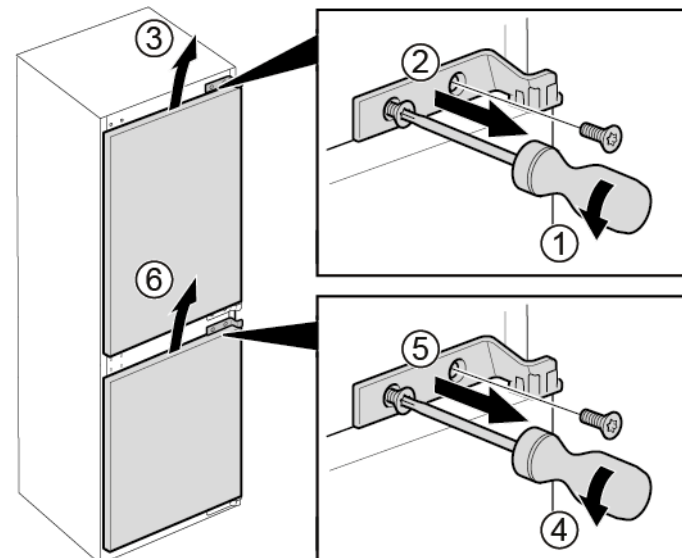

2. 1. Poista neljä ruuvia (1).
2. Poista alasarana (2).

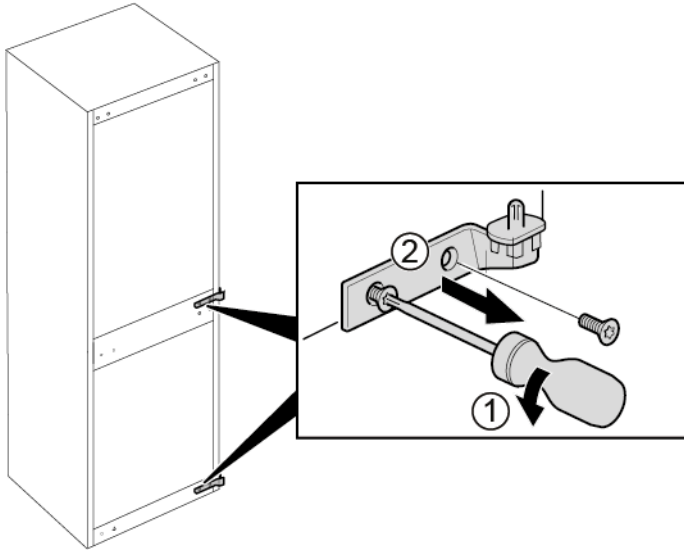

 Saranat on poistettu.

#### 4.3.2 Liukusaranan asennus

- ▶ Asenna vastakkaisessa järjestyksessä.

## 4.4 Ovihyllyn vaihtaminen

### Vaatus:

- ✔ Ovi on auki.

### 4.4.1 Ovihyllyn poistaminen

- ▶ Nosta ovihylly pois yläsuuntaan.

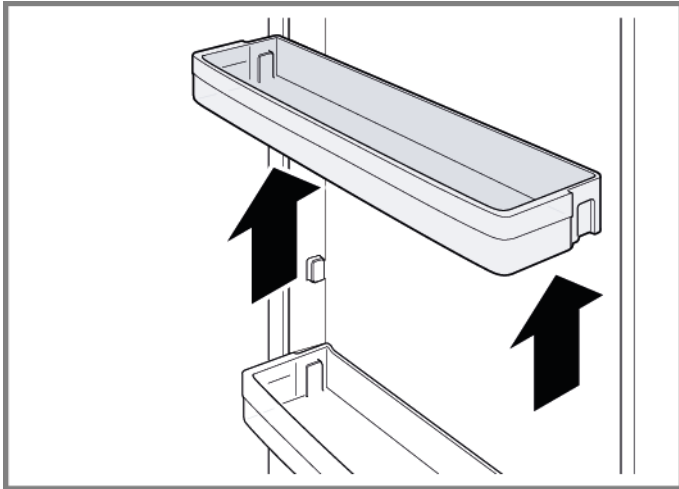

- ➡ Ovihylly on poistettu.

### 4.4.2 Ovihyllyn asennus

- ▶ Asenna vastakkaisessa järjestyksessä.

## 4.5 Hyllyn vaihtaminen

### Vaatus:

- ✔ Ovi on auki.

### 4.5.1 Hyllyn poistaminen

- ▶ Vedä hylly ulos.

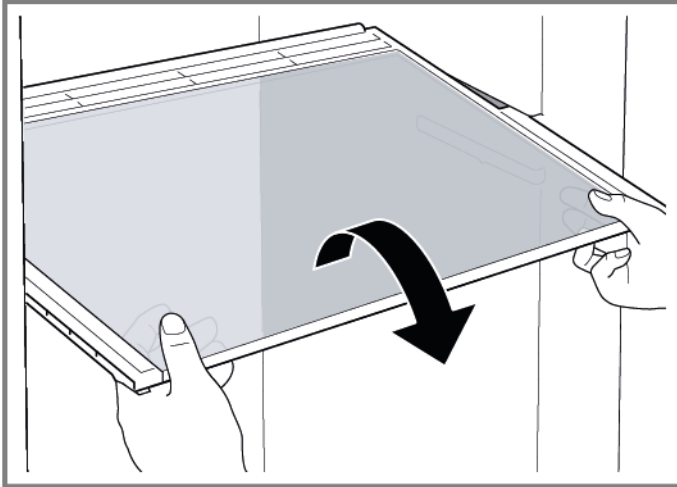

- ➡ Hylly on poistettu.

### 4.5.2 Hyllyn asennus

- ▶ Asenna vastakkaisessa järjestyksessä.



## 4.6 Ulosvedettävän hyllyn vaihtaminen

### Vaatus:

- ✔ Ovi on auki.

### 4.6.1 Ulosvedettävän hyllyn poistaminen

1. Vedä ulosvedettävää hyllyä ulos, kunnes lukitus avautuu.

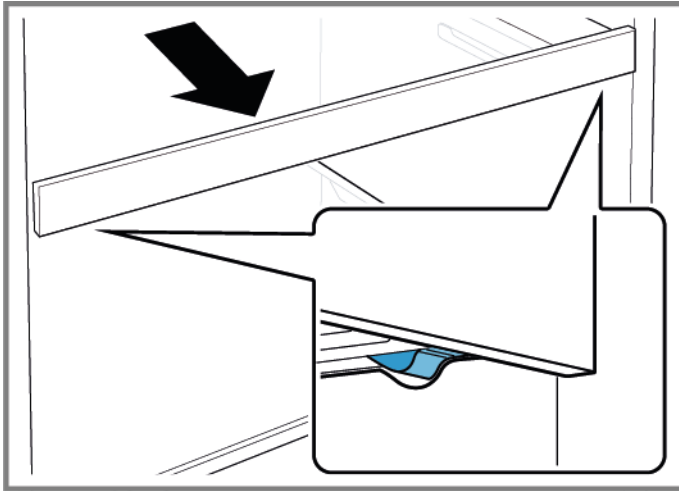

2. Laske ulosvedettävää hyllyä ja vedä se ulos sivuttain kääntämällä.
3. ➡ Ulosvedettävä hylly on poistettu.

### 4.6.2 Ulosvedettävän hyllyn asennus

- ▶ Asenna vastakkaisessa järjestyksessä.

## 4.7 Pakastinosan hyllyn vaihtaminen

### Vaatus:

- ✔ Ovi on auki.

### 4.7.1 Pakastinosan hyllyn poistaminen

- ▶ Vedä pakastinosan hylly ulos.

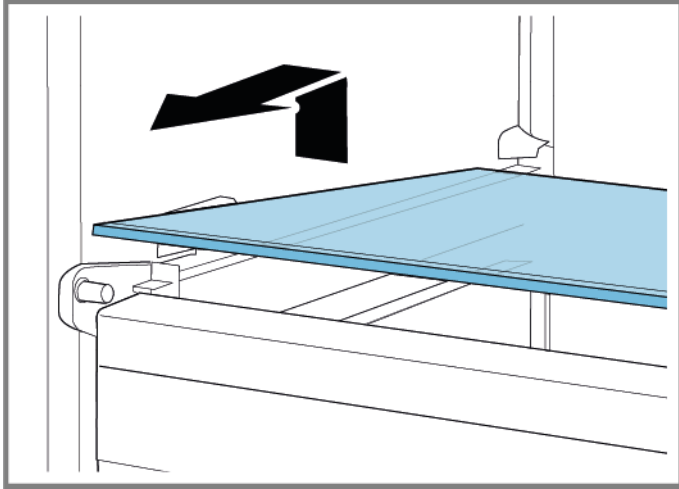

- ➡ Pakastinosan hylly on poistettu.

### 4.7.2 Pakastinosan hyllyn asennus

- ▶ Asenna vastakkaisessa järjestyksessä.

## 4.8 Pakastelokeron vaihtaminen

### Vaatus:

- ✔ Ovi on auki.

### 4.8.1 Pakastelokeron poistaminen

- ▶ 1. Vedä pakastelokero kokonaan ulos (1).
- ▶ 2. Poista pakastelokero (2).

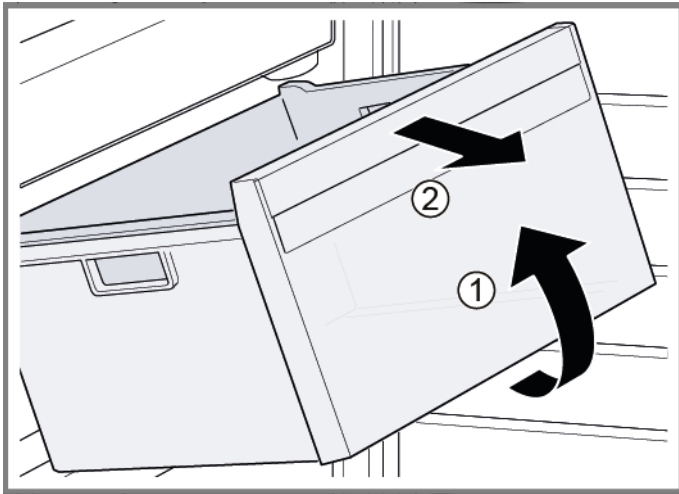

- ➡ Pakastelokero on poistettu.

### 4.8.2 Pakastelokeron asennus

- ▶ Asenna vastakkaisessa järjestyksessä.

## 4.9 Hedelmä- ja vihanneslokeron vaihtaminen

### Vaatus:

- ✔ Ovi on auki.

### 4.9.1 Hedelmä- ja vihanneslokeron poistaminen

- ▶ 1. Vedä lokero kokonaan ulos (1).
- ▶ 2. Poista lokero (2).

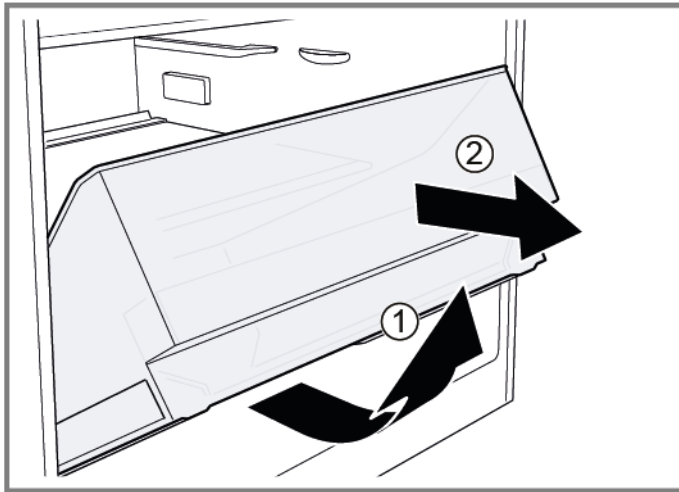

- ➡ Lokero on poistettu.

### 4.9.2 Hedelmä- ja vihanneslokeron asennus

- ▶ Asenna vastakkaisessa järjestyksessä.

## 4.10 Hedelmä- ja vihanneslokeron välilevyn ja suojuksen vaihtaminen

### Vaatus:

- ✓ Ovi on auki.

### 4.10.1 Hedelmä- ja vihanneslokeron välilevyn ja suojuksen poistaminen

1. Poista lasilevy välilevystä.

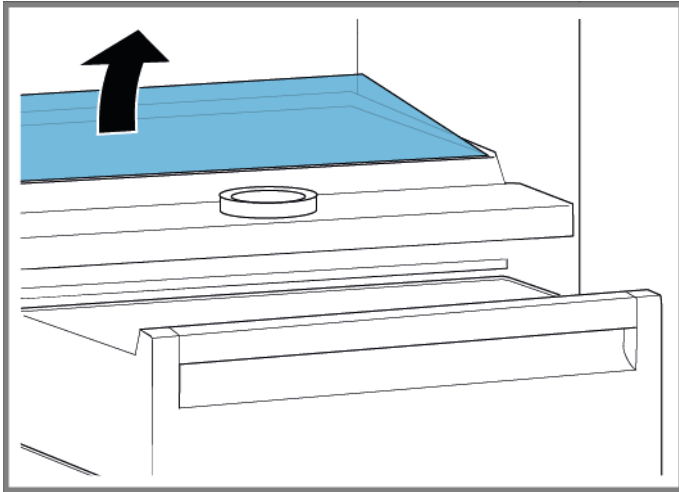

2. [Poista hedelmä- ja vihanneslokero. → 188](#)

3. 1. Paina vipua välilevyn kummallakin puolella alhaalla (1).
2. Vedä välilevyä etusuuntaan (2).

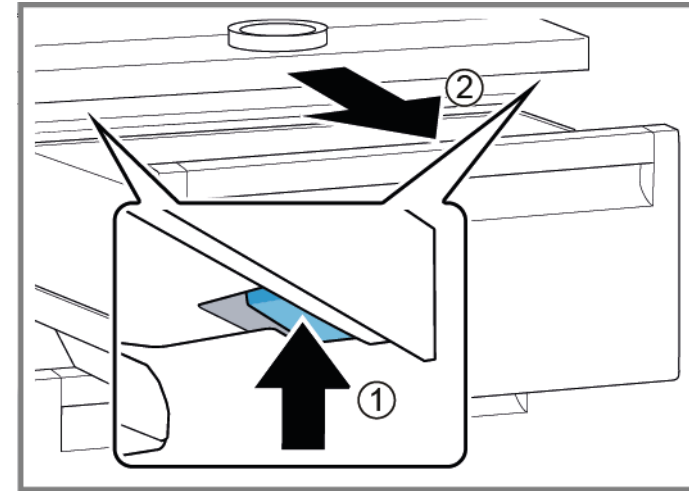

4. Nosta välilevyä ja vedä se ulos sivuttain kääntämällä.  
➡ Välilevy on poistettu.
5. 1. Nosta hedelmä- ja vihanneslokeron suojusta.  
2. Vedä hedelmä- ja vihanneslokeron suojusta etusuuntaan ja vedä se ulos sivuttain kääntämällä.  
➡ Hedelmä- ja vihanneslokeron suojus on poistettu.

### 4.10.2 Hedelmä- ja vihanneslokeron välilevyn ja suojuksen asennus

- ▶ Asenna vastakkaisessa järjestyksessä.

## 4.11 Cool-fresh-lokeron vaihtaminen

### Vaatus:

- ✔ Ovi on auki.

### 4.11.1 Cool-fresh-lokeron poistaminen

- ▶ 1. Kallista cool-fresh-lokeroa etusuuntaan (1).
- ▶ 2. Poista cool-fresh-lokero (2).

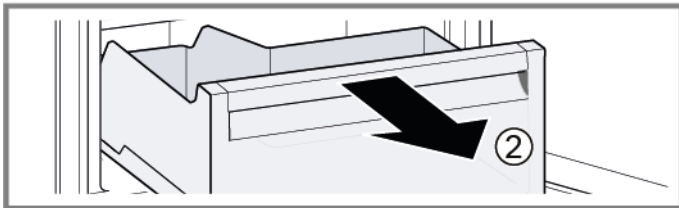
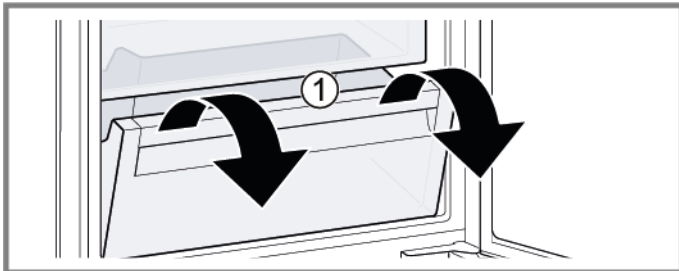

➡ Cool-fresh-lokero on poistettu.

### 4.11.2 Cool-fresh-lokeron asennus

- ▶ Asenna vastakkaisessa järjestyksessä.

## 4.12 Ulosvedettävän lokeron vaihtaminen

### Vaatus:

- ✔ Ovi on auki.

### 4.12.1 Ulosvedettävän lokeron poistaminen

- ▶ 1. Kallista ulosvedettävää lokeroa etusuuntaan (1).
- ▶ 2. Poista ulosvedettävä lokero (2).

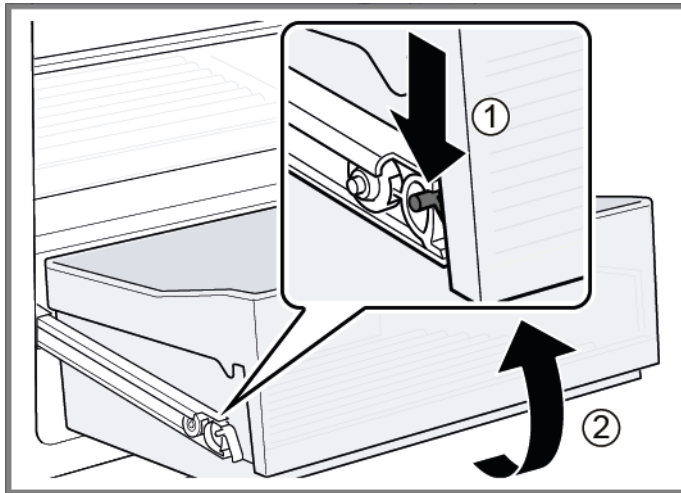



- ➡ Ulosvedettävä lokero on poistettu.

### 4.12.2 Ulosvedettävän lokeron asennus

- ▶ Asenna vastakkaisessa järjestyksessä.

## 4.13 LED-kohdevalon vaihtaminen

### Erikoistyökalut:

-  Erikoistyökalu [00342180]
-  Uruuvimeisseli Terä 2,4 mm x 0,4 mm x 60 mm, pakkauksessa [00341820]

 Laite on varustettu huoltovapaalla LED-valolla. Vain huoltopalvelu tai valtuutetut teknikot saavat korjata nämä valot!

 **VAARA**  
**Jännitteisten osien aiheuttama sähköiskun vaara!**  
 Sähköiskusta aiheutuva hengenvaara väärän korjauksen tapauksessa

- ▶ Sähköosien korjaus tulisi antaa pätevien sähköasentajien suoritettavaksi.
- ▶ Pyydä korjauksen jälkeen suorittamaan VDE 0701 -säädöksen tai maakohtaisten säädösten mukainen turvallisuustesti.



 **VAARA**  
**Jännitteisten osien aiheuttama sähköiskun vaara!**  
 Sähköiskun aiheuttama kuolema

- ▶ Erotta laitteet sähkövirrasta vähintään 60 sekuntia ennen korjaustöiden aloittamista.

 **HUOMAA**  
**Terävät reunat!**  
 Viiltovammat

- ▶ Käytä suojakäsineitä.

### Vaatus:

-  Kone on erotettu teholahteesta.
-  Ovi on auki.
-  Jääkaappiosan hyllyt on poistettu.

## 4.13.1 LED-kohdevalon poistaminen

1. Irrota LED-kohdevalon suojus.

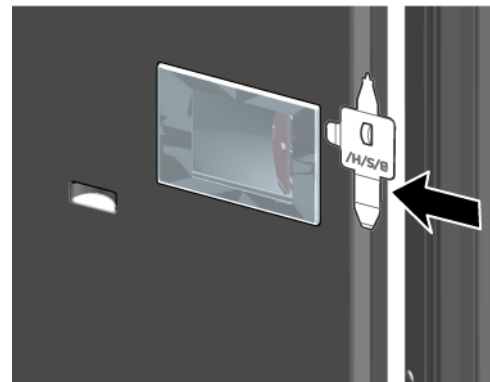

2. Vedä LED-kohdevalon suojusta sisäänpäin ja työnnä samalla eteenpäin.

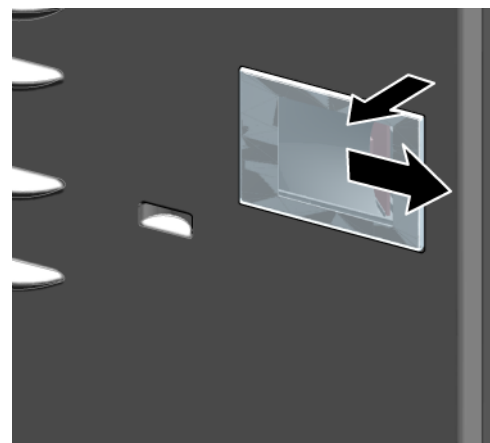



3. Irrota LED-kohdevalomoduuli.

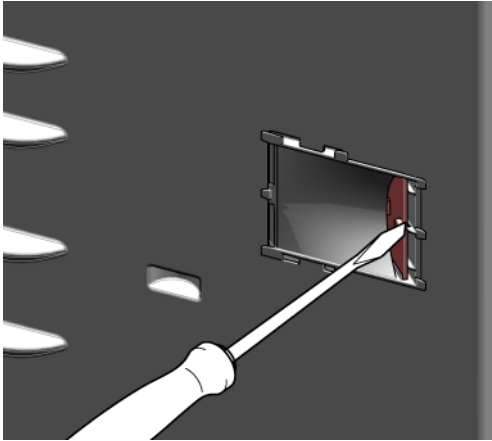

4. Irrota LED-kohdevalon sähköliitäntä.

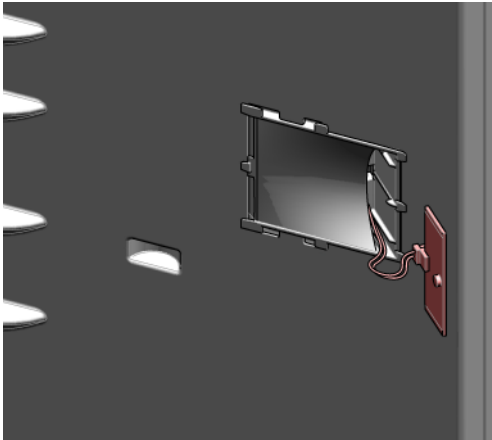





 LED-kohdevalo on poistettu.

## 4.13.2 LED-kohdevalon asennus

- ▶ Asenna vastakkaisessa järjestyksessä.

# Conseils de réparation - Réfrigérateur / Congélateur combiné

 <b>A propos de ce document</b> .....	<b>195</b>		
1.1 Informations importantes.....	195		
1.1.1 Objectif.....	195		
1.2 Explication des symboles.....	195		
1.2.1 Niveaux de risque.....	195		
1.2.2 Symboles de danger.....	195		
1.2.3 Structure des indications d'avertissement.....	196		
1.2.4 Symboles généraux.....	196		
 <b>Sécurité</b> .....	<b>197</b>		
2.1 Consignes de sécurité générales.....	197		
2.1.1 Tous les appareils électroménagers.....	197		
 <b>Outils et aides</b> .....	<b>198</b>		
 <b>Réparation</b> .....	<b>199</b>		
4.1 Remplacer le joint de porte.....	199		
4.1.1 Retirer le joint de porte.....	199		
4.1.2 Monter le joint de porte.....	199		
4.2 Remplacer la charnière plate.....	202		
4.2.1 Retirer la charnière plate.....	202		
4.2.2 Monter la charnière plate.....	204		
4.3 Remplacer la charnière à glissière.....	205		
4.3.1 Démontar la charnière à glissière.....	205		
4.3.2 Monter la charnière à glissière.....	206		
4.4 Remplacer l'étagère de la porte.....	207		
4.4.1 Retirer l'étagère de la porte.....	207		
4.4.2 Monter l'étagère de la porte.....	207		
4.5 Remplacer la tablette.....	208		
4.5.1 Retirer la tablette.....	208		
4.5.2 Monter la tablette.....	208		
4.6 Remplacer la tablette télescopique.....	209		
4.6.1 Retirer la tablette télescopique.....	209		
4.6.2 Monter la tablette télescopique.....	209		
4.7 Remplacer la tablette du compartiment congélateur.....	210		
4.7.1 Retirer la tablette du compartiment congélateur.....	210		
4.7.2 Monter la tablette du compartiment congélateur.....	210		
4.8 Remplacer le bac d'aliments congelés.....	211		
4.8.1 Retirer le bac d'aliments congelés.....	211		
4.8.2 Monter le bac d'aliments congelés.....	211		
4.9 Remplacer le bac de fruits et légumes.....	212		
4.9.1 Retirer le bac de fruits et légumes.....	212		
4.9.2 Monter le bac de fruits et légumes.....	212		
4.10 Remplacer la séparation et le couvercle du bac de fruits et légumes.....	213		
4.10.1 Retirer la séparation et le couvercle du bac de fruits et légumes.....	213		
4.10.2 Monter la séparation et le couvercle du bac de fruits et légumes.....	213		
4.11 Remplacer le bac cool-fresh.....	214		
4.11.1 Retirer le bac cool-fresh.....	214		
4.11.2 Monter le bac cool-fresh.....	214		
4.12 Remplacer le bac télescopique.....	215		
4.12.1 Extraire le bac télescopique.....	215		
4.12.2 Monter le bac télescopique.....	215		
4.13 Changer le projecteur LED.....	216		
4.13.1 Démontage du projecteur LED.....	216		
4.13.2 Monter le projecteur LED.....	217		

# **i** A propos de ce document

## 1.1 Informations importantes

### 1.1.1 Objectif

Les conseils de réparation qui suivent visent à permettre au consommateur de réparer l'appareil par lui-même, conformément au règlement sur l'écoconception (en vigueur le 03/2021).

Ils contiennent des informations sur le remplacement de certaines pièces de rechange précises, y compris des mises en garde.

Pour toute question, veuillez contacter notre service après-vente. Notre responsabilité pour les dommages est conditionnelle à l'observation des conseils de réparation.

## 1.2 Explication des symboles

### 1.2.1 Niveaux de risque

Les niveaux de risque se composent d'un symbole et d'un terme d'avertissement. Le mot d'avertissement caractérise la gravité du danger.









Niveau de dangerosité	Signification
 <b>DANGER</b>	Le non respect de la consigne d'avertissement provoque la mort ou des blessures graves.
 <b>AVERTISSEMENT</b>	Le non respect de la consigne d'avertissement peut provoquer la mort ou des blessures graves.
 <b>PRUDENCE</b>	Le non respect de la consigne d'avertissement peut provoquer des blessures légères.
 <b>ATTENTION !</b>	Le non respect de la consigne d'avertissement peut provoquer des dégâts matériels.

Tableau 1: Niveaux de risque

### 1.2.2 Symboles de danger

Les symboles de danger sont des représentations figuratives renseignant sur la nature du danger.

Ce document utilise les symboles de danger suivants:

Symbole de danger	Signification
	Consigne d'avertissement générale
	Danger engendré par la tension électrique
	Risque d'explosion
	Risque de blessures par coupure

## **i** A propos de ce document





Symbole de danger	Signification
	Risque de blessures par écrasement
	Danger engendré par des surfaces très chaudes
	Danger engendré par un champ magnétique puissant
	Danger engendré par un rayonnement non ionisant

Tableau 2: Symboles de danger

### 1.2.3 Structure des indications d'avertissement

Les consignes d'avertissement figurant dans ce document ont un aspect uniforme et une structure uniforme.

	<p><b>⚠ DANGER</b></p> <p><b>Type et source du danger !</b>            Conséquences possibles en cas de non-respect du danger / de l'avertissement.</p> <ul style="list-style-type: none"> <li>▶ Mesures et interdictions pour éviter le danger.</li> </ul>
--	---

L'exemple suivant montre une consigne d'avertissement mettant en garde contre le risque d'électrocution. La mesure permettant d'éviter le danger est nommée.

	<p><b>⚠ DANGER</b></p> <p><b>Risque d'électrocution par des pièces conductrices de tension !</b>            Mort par électrocution.</p> <ul style="list-style-type: none"> <li>▶ Débrancher l'appareil du secteur minimum 60 secondes avant de démarrer la réparation.</li> </ul>
--	---

### 1.2.4 Symboles généraux

Ce document utilise les symboles généraux suivants:







Symbole général	Signification
	Caractérisation d'une astuce particulière (texte et/ou graphique)
	Caractérisation d'une astuce simple (texte seul)
	Caractérisation d'un lien vers une vidéo
	Caractérisation d'outils nécessaires
	Caractérisation de conditions nécessaires
	Caractérisation d'une condition (si... , alors ...)
	Caractérisation d'un résultat
Start	Caractérisation d'une touche ou surface de commande
[00123456]	Caractérisation d'une référence de pièce
Statut	Caractérisation d'un texte affiché / fenêtre (sur l'afficheur)

Tableau 3: Symboles généraux

## 2.1 Consignes de sécurité générales

### 2.1.1 Tous les appareils électroménagers

#### **Risque d'électrocution en raison de pièces sous tension!**

- Des erreurs lors de réparations impliquant des composants électriques peuvent entraîner une décharge électrique!
- Débrancher l'appareil du secteur minimum 60 secondes avant de démarrer la réparation.
- Après la réparation, effectuer un test de sécurité selon VDE 0701 ou les réglementations spécifiques nationales.

#### **Risque de blessures par coupure sur des bords tranchants!**

- Porter des gants de protection.

#### **Risque de casse durant la réparation, maintenance, dépannage et SAV en raison de composants lourds et mobiles**

- Porter des chaussures de protection.
- Sécuriser les composants lourds contre le risque de chute.
- Ne pas coller les pièces du châssis sur les composants mobiles.



#### **Risque lié à la sécurité / fonction de l'appareil!**

- Utiliser uniquement des pièces détachées d'origine.

#### **Risque d'endommagement des composants sensibles aux décharges électrostatiques!**

- Ne pas toucher les modules, ni leur connexions et pistes conductrices.

## Outils et aides

Désignation	Détails	Images
Tissu de protection [00342013]	60 cm x 50 cm	
Embout Torx TX20 [00340865]	6,3 mm (1/4")	
Outil spécial [00342180]		

## 4.1 Remplacer le joint de porte

### Pré-requis:

- ✔ La porte est ouverte.

### 4.1.1 Retirer le joint de porte

1. Sortir le joint de porte de la rainure dans les coins gauche et droit.

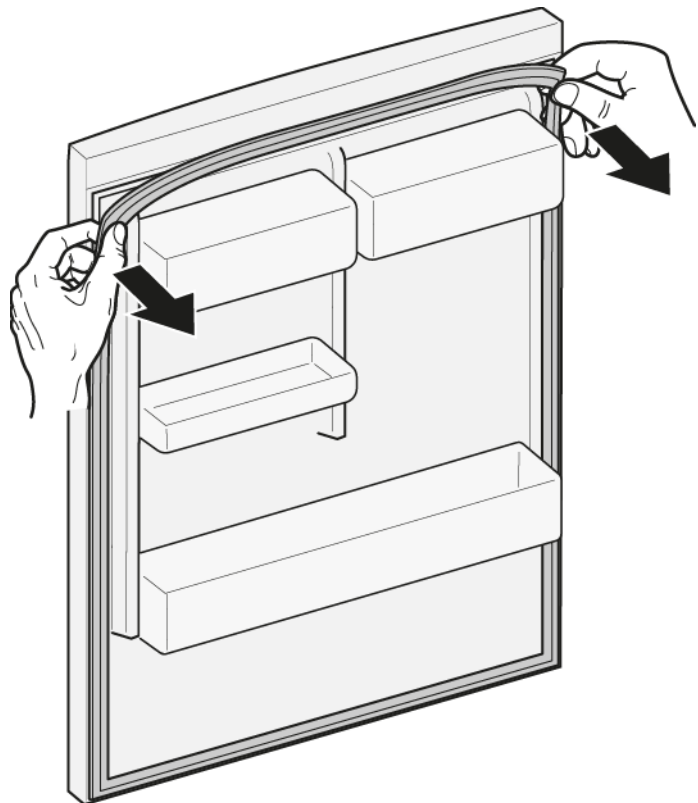

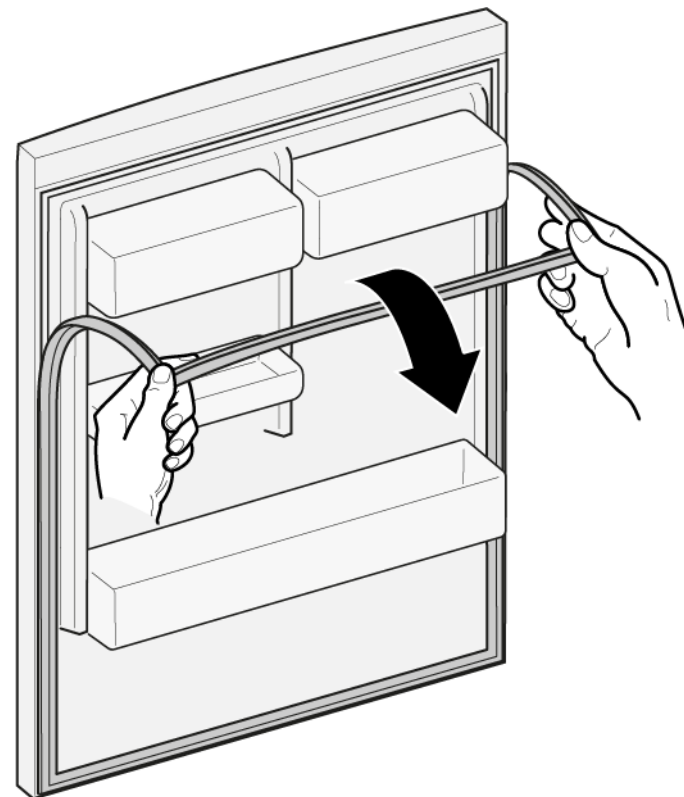

2. Retirer le joint de porte de la rainure.



- ➡ Le joint de porte est retiré.

### 4.1.2 Monter le joint de porte

	L'épaisseur du nouveau joint de porte peut différer légèrement de celle de l'ancien. Cela n'affectera en rien la fermeture ou le fonctionnement à long terme de la porte.
	Si votre appareil est doté de charnière ou d'attaches de charnières ajustables, vous pourrez optimiser le comportement de fermeture par la suite.
	Les petits trous latéraux dans les joints de porte sont fonctionnels (nécessaires pour la ventilation). Il ne s'agit pas de défauts de production.

## Réparation

1. S'assurer de l'absence de dégâts dans les rainures qui doivent accueillir le joint.

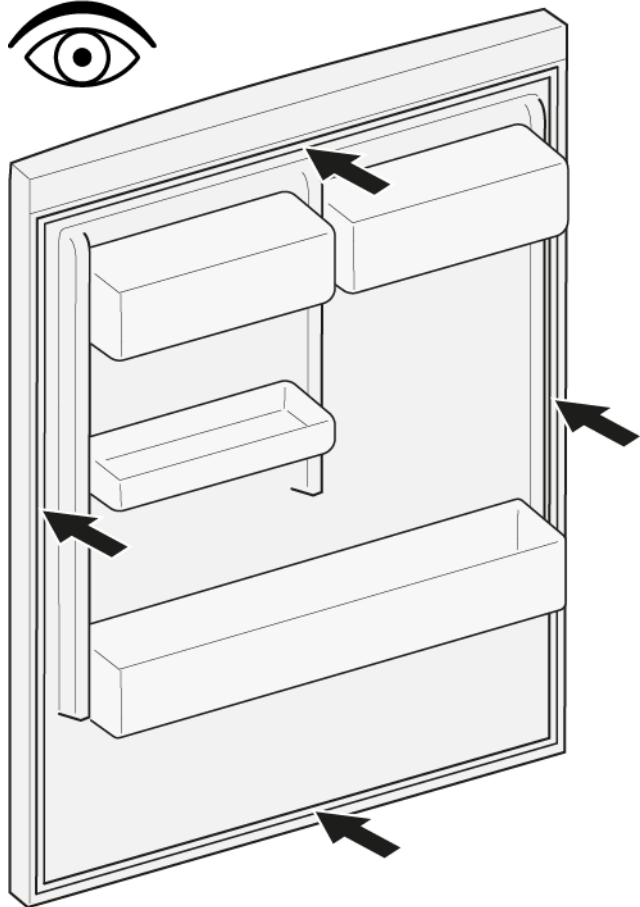

4. Pousser les coins du joint en haut et en bas dans la rainure.

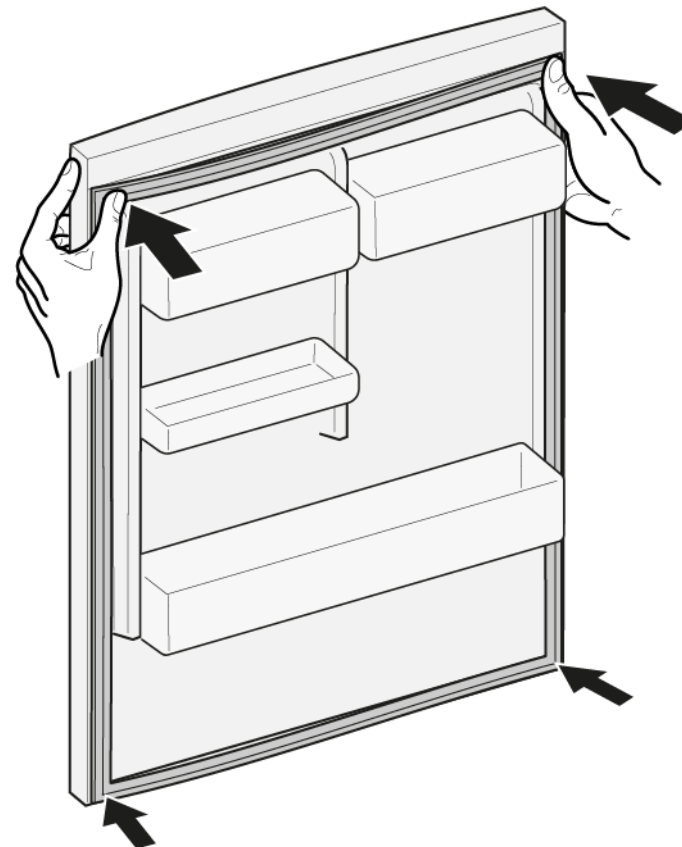

2.  Si la rainure de joint est endommagée.  
- Contacter le service après-vente.

3.  Une légère déformation du joint est normale et ne saurait en affecter le fonctionnement. Il est recommandé de redresser le joint de porte avant de l'insérer dans l'appareil.

Réchauffer le joint de porte avec un sèche-cheveux ou de l'eau chaude et le reformer manuellement.



## Réparation

5. Enfoncer progressivement le joint dans la rainure.

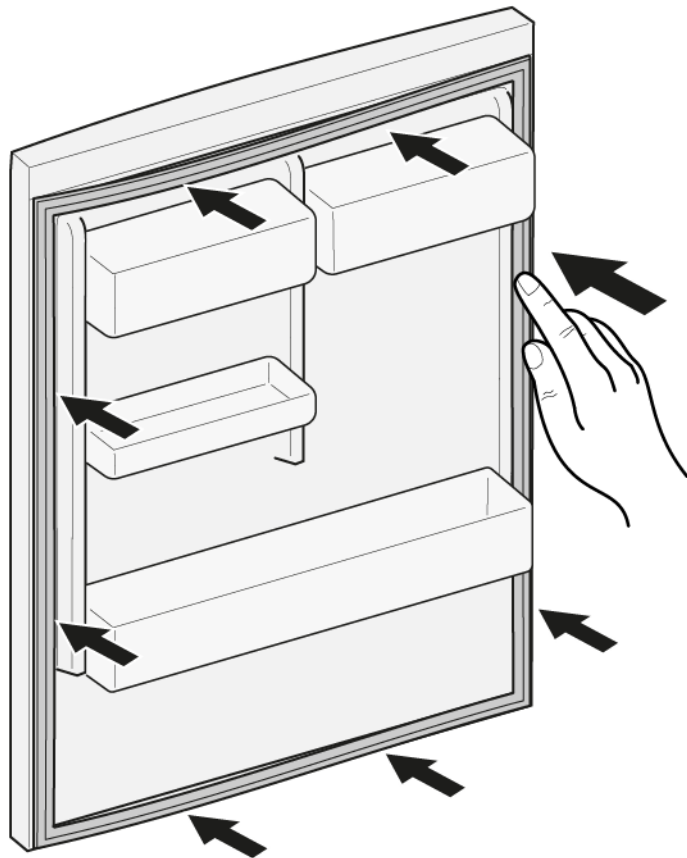

-  Le joint de porte est installé.

## 4.2 Remplacer la charnière plate

### Outillage nécessaire:

🌀 Embout Torx TX20      6,3 mm (1/4")      [00340865]

	<b>⚠️ AVERTISSEMENT</b>
	<p><b>Appareils lourds et volumineux !</b> Blessures dorsales et musculaires</p> <ul style="list-style-type: none"> <li>▶ Seuls des spécialistes dûment formés devraient retirer la porte de l'appareil.</li> <li>▶ Pour déplacer l'appareil, deux personnes sont nécessaires.</li> <li>▶ Utiliser seulement des outils et de l'équipement appropriés.</li> </ul>

	<b>⚠️ PRUDENCE</b>
	<p><b>Arêtes vives !</b> Blessures par coupure</p> <ul style="list-style-type: none"> <li>▶ Porter des gants de protection.</li> </ul>

	<b>⚠️ PRUDENCE</b>
	<p><b>Ouvrir la zone de charnière !</b> Écrasement/coincement des doigts</p> <ul style="list-style-type: none"> <li>▶ Ne pas insérer les doigts dans la zone de la charnière.</li> <li>▶ Porter des gants de protection.</li> </ul>

	<b>⚠️ PRUDENCE</b>
	<p><b>Risque de pièces qui chutent en raison de vis trop lâches !</b> Blessures dues à des pièces qui chutent.</p> <ul style="list-style-type: none"> <li>▶ Sécuriser les composants contre le risque de chute.</li> </ul>

	<b>ATTENTION !</b>
	<p><b>Risque de pièces qui chutent en raison de vis trop lâches !</b> Dommages à d'autres parties de l'appareil ou à la propriété du client, p. ex. au plancher.</p> <ul style="list-style-type: none"> <li>▶ Sécuriser les composants contre le risque de chute.</li> </ul>

### Pré-requis:

- ✅ Appareil est déconnecté de l'alimentation.
- ✅ La porte du meuble est retirée. Voir les instructions de montage.
- ✅ La porte est ouverte.

### 4.2.1 Retirer la charnière plate

Veiller à ce que les charnières ne se ferment pas durant le retrait/le montage.

1. Retirer quatre caches de charnière.

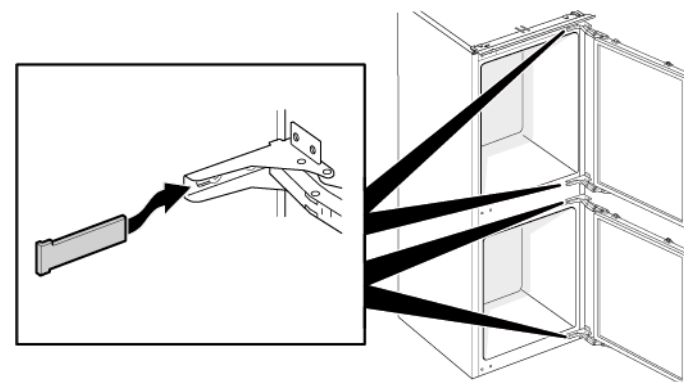

## Réparation

2. 1. Desserrer quatre vis (1).  
2. Faire glisser la porte supérieure pour l'extraire (2).

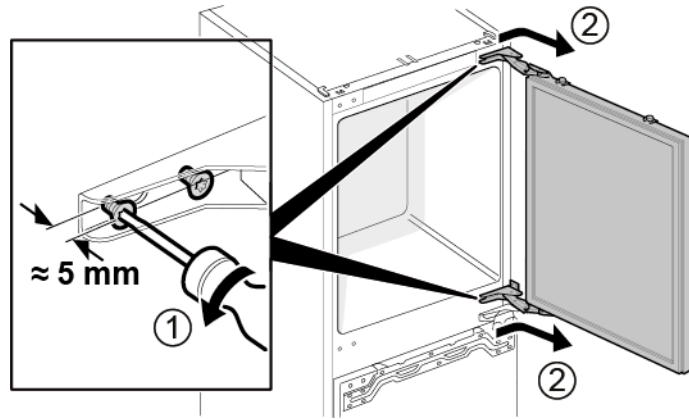

3. 1. Retirer quatre vis (1).  
2. Retirer les charnières (2).

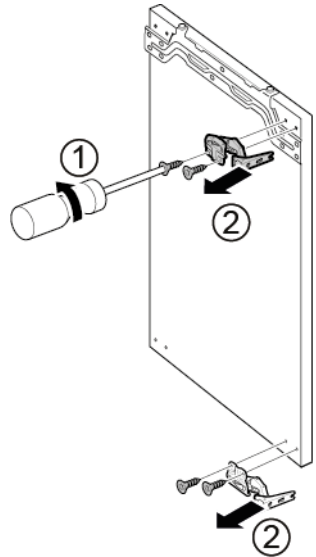

 Les charnières supérieures de la porte sont retirées.

4. 1. Desserrer quatre vis (1).  
2. Faire glisser la porte inférieure pour l'extraire (2).

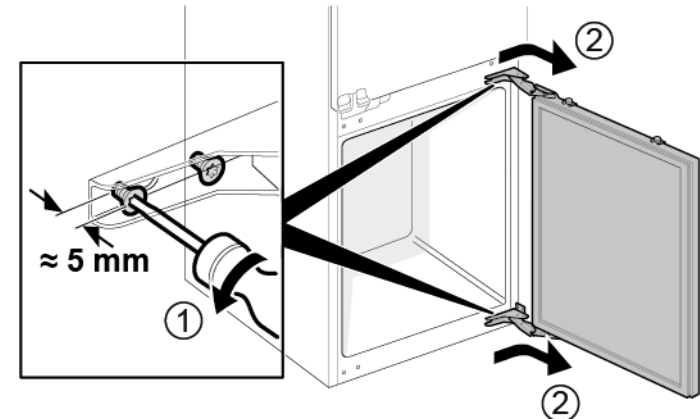

5. 1. Retirer quatre vis (1).  
2. Retirer les charnières (2).

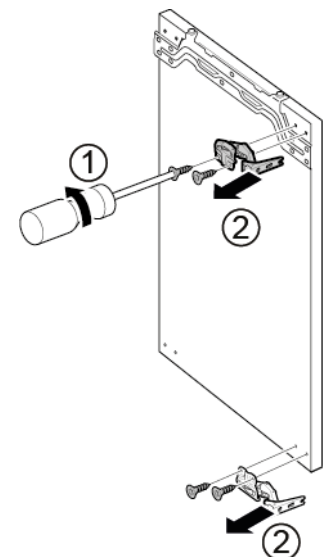

 Les charnières de la porte sont retirées.

### 4.2.2 Monter la charnière plate

- ▶ Le montage s'effectue dans l'ordre chronologique inverse.

## 4.3 Remplacer la charnière à glissière

### Outillage nécessaire:

🌀 Embout Torx TX20      6,3 mm (1/4")      [00340865]

	<b>⚠️ AVERTISSEMENT</b>
	<b>Appareils lourds et volumineux !</b> Blessures dorsales et musculaires <ul style="list-style-type: none"><li>▶ Seuls des spécialistes dûment formés devraient retirer la porte de l'appareil.</li><li>▶ Pour déplacer l'appareil, deux personnes sont nécessaires.</li><li>▶ Utiliser seulement des outils et de l'équipement appropriés.</li></ul>

	<b>⚠️ PRUDENCE</b>
	<b>Arêtes vives !</b> Blessures par coupure <ul style="list-style-type: none"><li>▶ Porter des gants de protection.</li></ul>

	<b>⚠️ PRUDENCE</b>
	<b>Risque de pièces qui chutent en raison de vis trop lâches !</b> Blessures dues à des pièces qui chutent. <ul style="list-style-type: none"><li>▶ Sécuriser les composants contre le risque de chute.</li></ul>

	<b>⚠️ ATTENTION !</b>
	<b>Risque de pièces qui chutent en raison de vis trop lâches !</b> Dommages à d'autres parties de l'appareil ou à la propriété du client, p. ex. au plancher. <ul style="list-style-type: none"><li>▶ Sécuriser les composants contre le risque de chute.</li></ul>

### Pré-requis:

- ✔ Appareil est déconnecté de l'alimentation.
- ✔ La porte du meuble et la porte de l'appareil sont séparées. Voir les instructions de montage.

### 4.3.1 Démonter la charnière à glissière

1. Dévisser deux vis (1).
2. Retirer la charnière supérieure de la porte supérieure (2).
3. Retirer la porte supérieure (3).
4. Dévisser deux vis (4).
5. Retirer la charnière supérieure de la porte inférieure (5).
6. Retirer la porte inférieure (6).

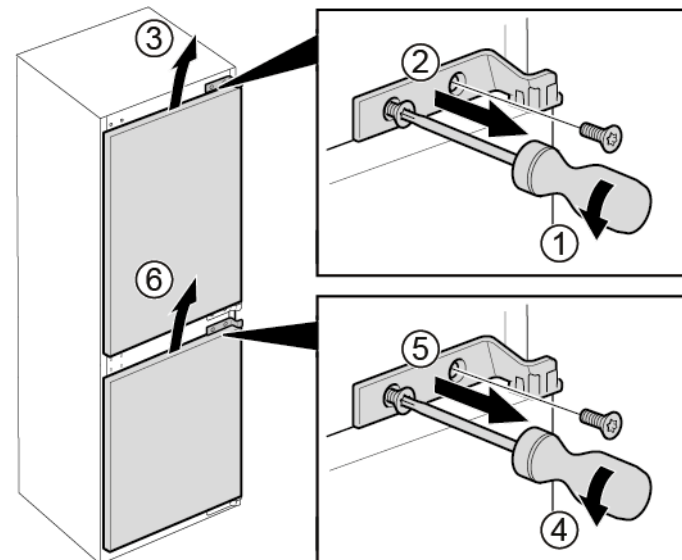

## Réparation

2. 1. Retirer quatre vis (1).
2. Retirer les charnières inférieures (2).

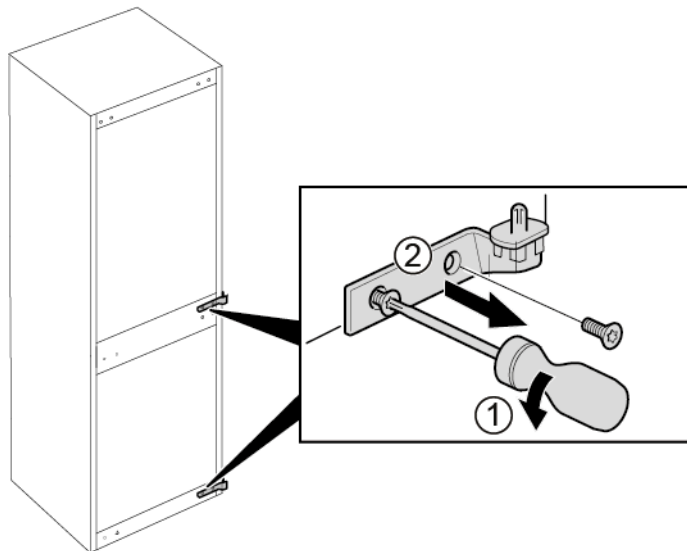

 Les charnières sont retirées.

### 4.3.2 Monter la charnière à glissière

- ▶ Le montage s'effectue dans l'ordre chronologique inverse.

## 4.4 Remplacer l'étagère de la porte

### Pré-requis:

- ✔ La porte est ouverte.

### 4.4.1 Retirer l'étagère de la porte

- ▶ Soulever l'étagère de la porte.

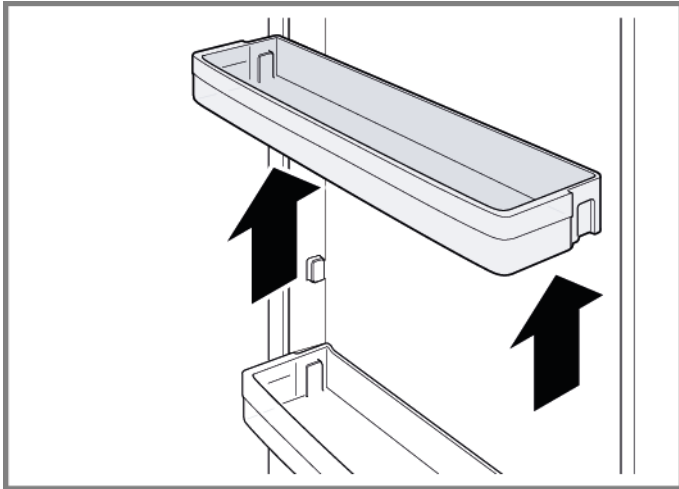

➡ L'étagère de la porte est retirée.

### 4.4.2 Monter l'étagère de la porte

- ▶ Le montage s'effectue dans l'ordre chronologique inverse.

## 4.5 Remplacer la tablette

### Pré-requis:

- ✔ La porte est ouverte.

### 4.5.1 Retirer la tablette

- ▶ Extraire la tablette.

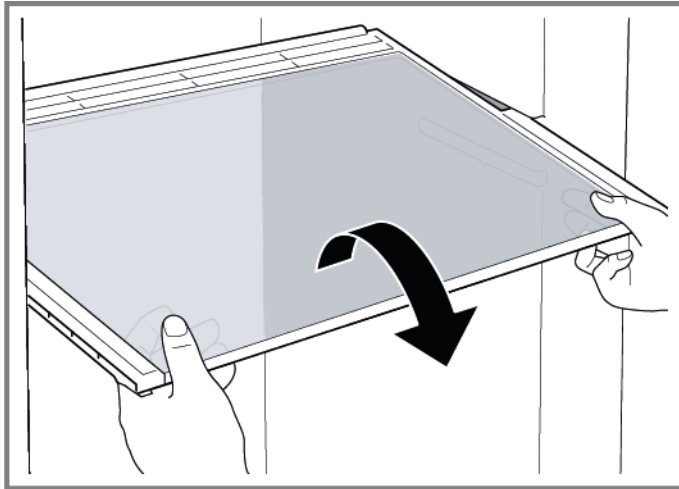

- ➡ La tablette est retirée.

### 4.5.2 Monter la tablette

- ▶ Le montage s'effectue dans l'ordre chronologique inverse.



## 4.6 Remplacer la tablette télescopique

### Pré-requis:

- ✔ La porte est ouverte.

### 4.6.1 Retirer la tablette télescopique

1. Extraire la tablette télescopique jusqu'à ce que la languette de verrouillage se débloque.

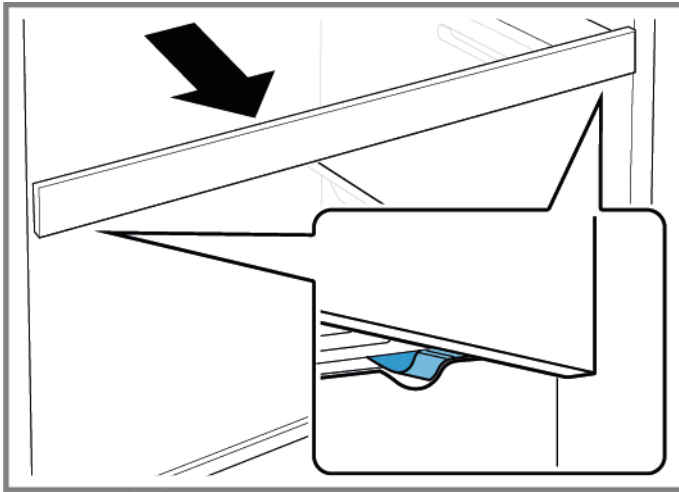

2. Abaisser la tablette télescopique inférieure et la faire pivoter sur le côté.
3. ➡ La tablette télescopique est retirée.

### 4.6.2 Monter la tablette télescopique

- ▶ Le montage s'effectue dans l'ordre chronologique inverse.

## 4.7 Remplacer la tablette du compartiment congélateur

### Pré-requis:

- ✔ La porte est ouverte.

### 4.7.1 Retirer la tablette du compartiment congélateur

- ▶ Extraire la tablette du compartiment congélateur.

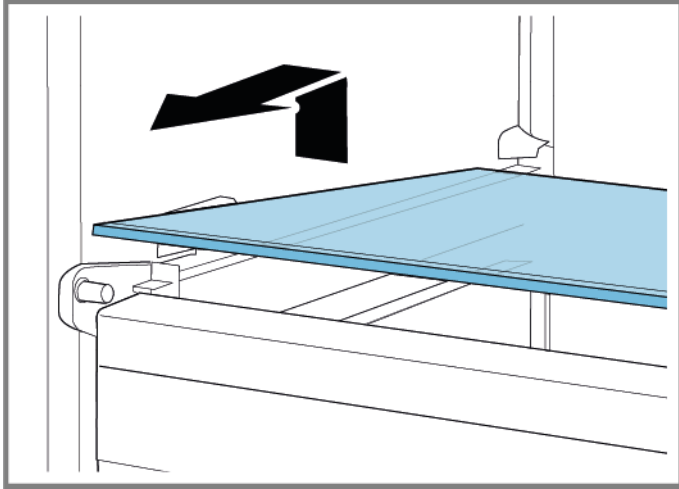

- ➡ La tablette du compartiment congélateur est retirée.

### 4.7.2 Monter la tablette du compartiment congélateur

- ▶ Le montage s'effectue dans l'ordre chronologique inverse.

## 4.8 Remplacer le bac d'aliments congelés

### Pré-requis:

- ✔ La porte est ouverte.

### 4.8.1 Retirer le bac d'aliments congelés

- ▶ 1. Extraire complètement le bac d'aliments congelés (1).
- ▶ 2. Retirer le bac d'aliments congelés (2).

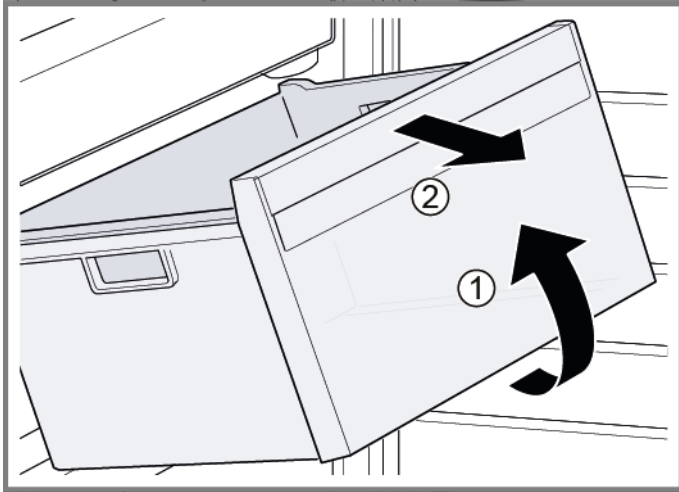

- ➡ Le bac d'aliments congelés est retiré.

### 4.8.2 Monter le bac d'aliments congelés

- ▶ Le montage s'effectue dans l'ordre chronologique inverse.

## 4.9 Remplacer le bac de fruits et légumes

### Pré-requis:

- ✔ La porte est ouverte.

### 4.9.1 Retirer le bac de fruits et légumes

- ▶ 1. Extraire complètement le bac (1).
- ▶ 2. Retirer le bac (2).

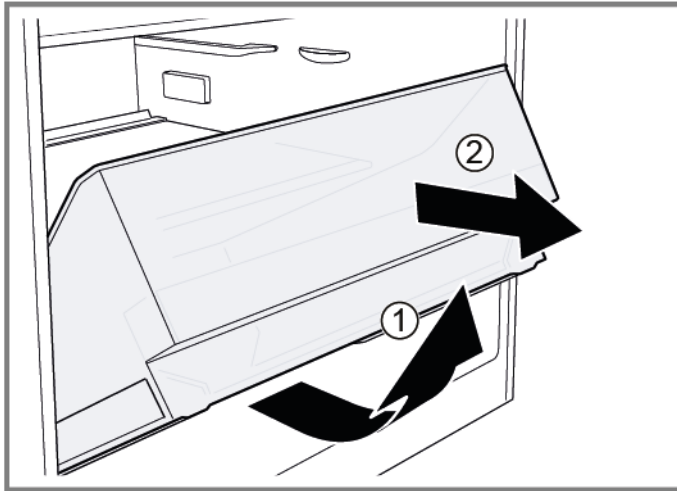

- ➡ Le bac est retiré.

### 4.9.2 Monter le bac de fruits et légumes

- ▶ Le montage s'effectue dans l'ordre chronologique inverse.

### 4.10 Remplacer la séparation et le couvercle du bac de fruits et légumes

#### Pré-requis:

- ✔ La porte est ouverte.

#### 4.10.1 Retirer la séparation et le couvercle du bac de fruits et légumes

1. Retirer la plaque verre de la séparation.

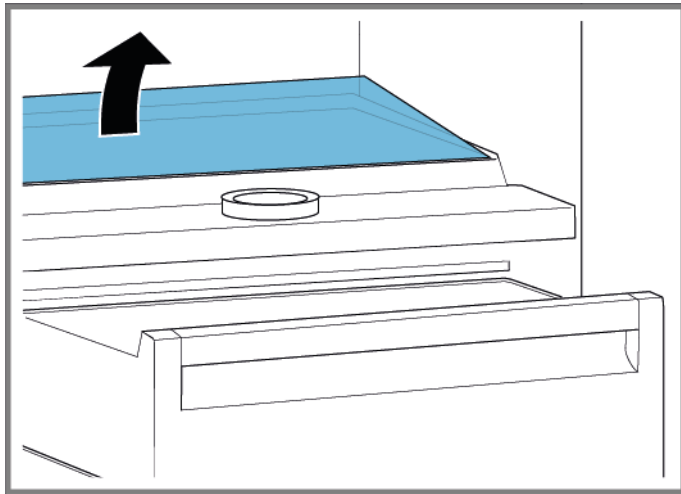

2. [Retirer le bac de fruits et légumes. → 212](#)

3. 1. Appuyer sur le levier sous chaque côté de la séparation (1).
2. Tirer la séparation vers l'avant (2).

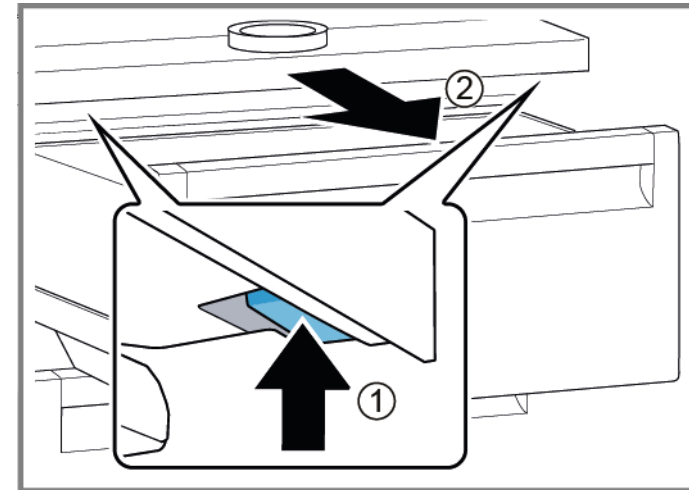

4. Soulever la séparation et la faire pivoter sur le côté.  
➡ La séparation est retirée.
5. 1. Soulever le couvercle du bac de fruits et légumes.  
2. Soulever le couvercle du bac de fruits et légumes vers l'avant et le faire pivoter sur le côté.  
➡ Le couvercle du bac de fruits et légumes est retiré.

#### 4.10.2 Monter la séparation et le couvercle du bac de fruits et légumes

- ▶ Le montage s'effectue dans l'ordre chronologique inverse.

## 4.11 Remplacer le bac cool-fresh

### Pré-requis:

- ✔ La porte est ouverte.

### 4.11.1 Retirer le bac cool-fresh

- ▶ 1. Pencher le bac cool-fresh vers l'avant (1).
- ▶ 2. Retirer le bac cool-fresh (2).

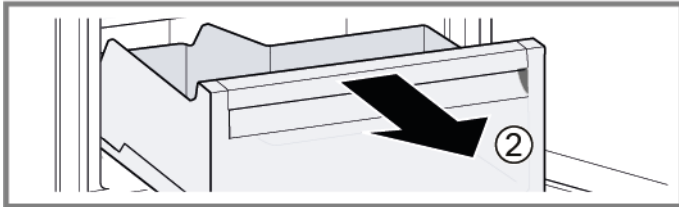
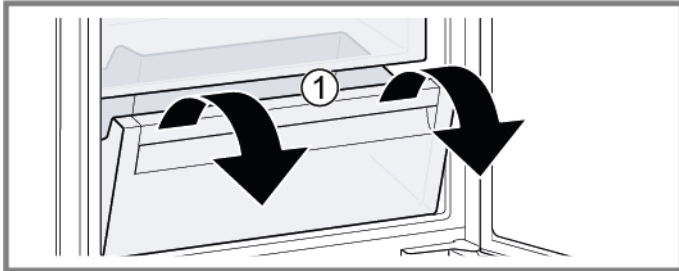

➡ Le bac cool-fresh est retiré.

### 4.11.2 Monter le bac cool-fresh

- ▶ Le montage s'effectue dans l'ordre chronologique inverse.

## 4.12 Remplacer le bac télescopique

### Pré-requis:

- ✔ La porte est ouverte.

### 4.12.1 Extraire le bac télescopique

- ▶ 1. Pencher le bac télescopique vers l'avant (1).
- ▶ 2. Retirer le bac télescopique (2).

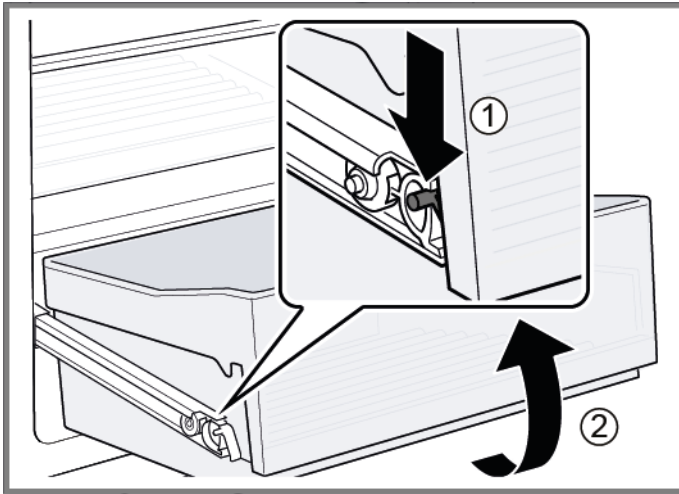

➡ Le bac télescopique est retiré.

### 4.12.2 Monter le bac télescopique

- ▶ Le montage s'effectue dans l'ordre chronologique inverse.

## 4.13 Changer le projecteur LED

### Outillage nécessaire:

- 🔧 Outil spécial [00342180]
- 🔧 Tournevis plat      Lame 2.4 mm x 0.4 mm x 60 mm, dans le kit [00341820]

**i** Votre appareil est équipé d'un éclairage LED ne demandant pas d'entretien. Les réparations de cet éclairage sont exclusivement réservées au service après-vente ou à des spécialistes autorisés!

**⚠ DANGER**  
**Risque d'électrocution en raison de pièces sous tension !**  
Risque d'électrocution en cas de réparation non conforme

- ▶ Les pièces électriques doivent être réparées par des techniciens qualifiés.
- ▶ Après la réparation, effectuer un test de sécurité selon VDE 0701 ou les régulations spécifiques nationales.

**⚠ DANGER**  
**Risque d'électrocution par des pièces conductrices de tension !**  
Mort par électrocution.

- ▶ Débrancher l'appareil du secteur minimum 60 secondes avant de démarrer la réparation.

**⚠ PRUDENCE**  
**Arêtes vives !**  
Blessures par coupure

- ▶ Porter des gants de protection.

### Pré-requis:

- ✔ Appareil est déconnecté de l'alimentation.
- ✔ La porte est ouverte.
- ✔ Les clayettes du réfrigérateur sont retirées.

### 4.13.1 Démontage du projecteur LED

1. Défaire le cache du projecteur LED.

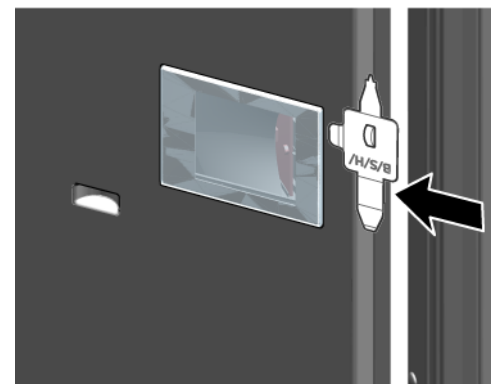

2. Tirer le cache du projecteur LED vers l'intérieur et le pousser simultanément vers l'avant.

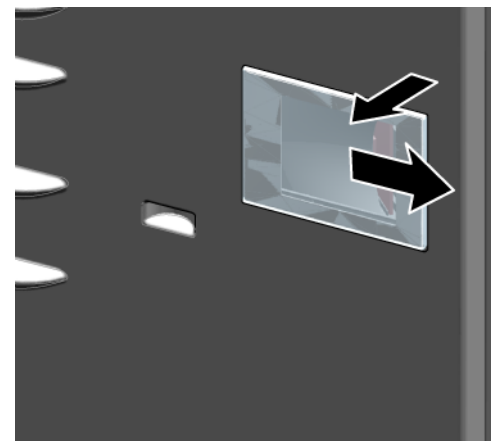



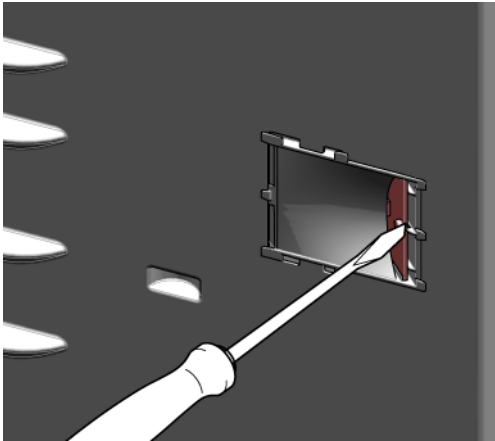

3. Défaire le module projecteur LED.

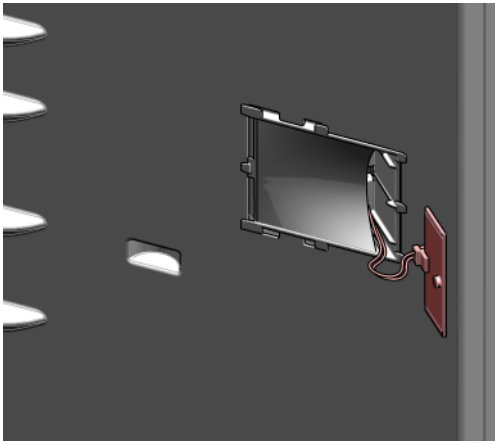

4. Défaire le raccord électrique du projecteur LED.



-  Le projecteur LED est retiré.

### 4.13.2 Monter le projecteur LED

- ▶ Le montage s'effectue dans l'ordre chronologique inverse.

# Reparatur Hinweise - Kühl- und Gefrierkombination

## **Zu diesem Dokument**..... 219

1.1	Wichtige Hinweise:	219
1.1.1	Zweck	219
1.2	Zeichenerklärung	219
1.2.1	Gefahrenstufen	219
1.2.2	Gefahrensymbole	219
1.2.3	Struktur der Warnhinweise	220
1.2.4	Allgemeine Symbole	220

## **Sicherheit**..... 221

2.1	Allgemeine Sicherheitshinweise	221
2.1.1	Alle Hausgeräte	221

## **Werkzeuge und Hilfsmittel**..... 222

## **Instandsetzen** ..... 223

4.1	Austauschen der Türdichtung	223
4.1.1	Ausbauen der Türdichtung	223
4.1.2	Einbauen der Türdichtung	223
4.2	Austauschen des Flachscharniers	226
4.2.1	Ausbauen des Flachscharniers	226
4.2.2	Einbauen des Flachscharniers	228
4.3	Austauschen des Schleppscharniers	229
4.3.1	Ausbauen des Schleppscharniers	229
4.3.2	Einbauen des Schleppscharniers	230
4.4	Austauschen des Türabstellers	231
4.4.1	Ausbauen des Türabstellers	231
4.4.2	Einbauen des Türabstellers	231
4.5	Austauschen der Ablage	232
4.5.1	Ausbauen der Ablage	232
4.5.2	Einbauen der Ablage	232
4.6	Austauschen der ausziehbaren Ablage	233
4.6.1	Ausbauen der ausziehbaren Ablage	233
4.6.2	Einbauen der ausziehbaren Ablage	233
4.7	Austauschen der Gefrierfachablage	234
4.7.1	Ausbauen der Gefrierfachablage	234
4.7.2	Einbauen der Gefrierfachablage	234

4.8	Austauschen des Gefriergutbehälters	235
4.8.1	Ausbauen des Gefriergutbehälters	235
4.8.2	Einbauen des Gefriergutbehälters	235
4.9	Austauschen des Obst- und Gemüsebehälters	236
4.9.1	Ausbauen des Obst- und Gemüsebehälters	236
4.9.2	Einbauen des Obst- und Gemüsebehälters	236
4.10	Austauschen der Trennplatte und der Abdeckung des Obst- und Gemüsebehälters	237
4.10.1	Ausbauen der Trennplatte und der Abdeckung des Obst- und Gemüsebehälters	237
4.10.2	Einbauen der Trennplatte und der Abdeckung des Obst- und Gemüsebehälters	237
4.11	Austauschen des Frischkühlbehälters	238
4.11.1	Ausbauen des Frischkühlbehälters	238
4.11.2	Einbauen des Frischkühlbehälters	238
4.12	Austauschen des ausziehbaren Behälters	239
4.12.1	Ausbauen des ausziehbaren Behälters	239
4.12.2	Einbauen des ausziehbaren Behälters	239
4.13	Austauschen des LED-Strahlers	240
4.13.1	Ausbauen des LED-Strahlers	240
4.13.2	Einbauen des LED-Strahlers	241

# Zu diesem Dokument

## 1.1 Wichtige Hinweise:

### 1.1.1 Zweck

Diese Reparaturhinweise dienen zur Unterstützung des Kunden bei der selbständigen Geräte-Reparatur gemäß der entsprechenden Ökodesign-Richtlinie (ab 03/2021).

Sie enthalten Informationen zum Austausch bestimmter Ersatzteile sowie Warn- und Gefahrenhinweise.

Bitte wenden Sie sich in Zweifelsfällen an unseren Kundendienst. Bei nicht ordnungsgemäßer Befolgung der Reparaturhinweise ist die Schadenshaftung ausgeschlossen.

## 1.2 Zeichenerklärung

### 1.2.1 Gefahrenstufen

Die Gefahrenstufen bestehen aus einem Symbol und einem Signalwort. Das Signalwort kennzeichnet die Schwere der Gefahr.









Gefahrenstufe	Bedeutung
	Nichtbeachtung des Warnhinweises führt zu Tod oder schweren Verletzungen.
	Nichtbeachtung des Warnhinweises kann zu Tod oder schweren Verletzungen führen.
	Nichtbeachtung des Warnhinweises kann zu leichten Verletzungen führen.
	Nichtbeachtung des Warnhinweises kann zu Sachschäden führen.

Tabelle 1: Gefahrenstufen

### 1.2.2 Gefahrensymbole

Gefahrensymbole sind sinnbildliche Darstellungen, die einen Hinweis auf die Art der Gefahr geben.

In diesem Dokument werden folgende Gefahrensymbole verwendet:

Gefahrensymbol	Bedeutung
	Allgemeiner Warnhinweis
	Gefahr durch elektrische Spannung
	Gefahr durch Explosion
	Gefahr von Schnittverletzungen
	Gefahr von Quetschverletzungen

## **i** Zu diesem Dokument





Gefahrensymbol	Bedeutung
	Gefahr durch heiße Oberflächen
	Gefahr durch starkes Magnetfeld
	Gefahr durch nicht ionisierende Strahlung

Tabelle 2: Gefahrensymbole

### 1.2.3 Struktur der Warnhinweise

Warnhinweise haben in diesem Dokument ein einheitliches Aussehen und eine einheitliche Struktur.



	<div style="background-color: red; color: white; padding: 2px; text-align: center;"><b>⚠ GEFAHR</b></div> <p><b>Art und Quelle der Gefahr!</b> Mögliche Folgen bei Nichtbeachtung der Gefahr / des Warnhinweises.</p> <ul style="list-style-type: none"> <li>▶ Maßnahmen und Verbote zur Vermeidung der Gefahr.</li> </ul>
--	--

Das folgende Beispiel zeigt einen Warnhinweis, der vor Stromschlaggefahr durch spannungsführende Teile warnt. Die Maßnahme zur Vermeidung der Gefahr wird genannt.

	<div style="background-color: red; color: white; padding: 2px; text-align: center;"><b>⚠ GEFAHR</b></div> <p><b>Stromschlaggefahr durch spannungsführende Teile!</b> Tod durch Stromschlag</p> <ul style="list-style-type: none"> <li>▶ Gerät mindestens 60 Sekunden vor Reparaturbeginn vom Netz trennen.</li> </ul>
--	---

### 1.2.4 Allgemeine Symbole

In diesem Dokument werden folgende allgemeine Symbole verwendet:

Allg. Symbol	Bedeutung
	Kennzeichnung eines besonderen (Text und/oder Grafik) Tipps
	Kennzeichnung eines einfachen (nur Text) Tipps

Allg. Symbol	Bedeutung
	Kennzeichnung eines Links zu einer Videoanleitung
	Kennzeichnung erforderlicher Werkzeuge
	Kennzeichnung erforderlicher Voraussetzungen
	Kennzeichnung einer Bedingung (Wenn ..., dann ...)
	Kennzeichnung eines Ergebnisses
[Start]	Kennzeichnung einer Taste oder Schaltfläche
[00123456]	Kennzeichnung einer Materialnummer
Status	Kennzeichnung eines angezeigten Textes / Fensters (im Gerätedisplay)

Tabelle 3: Allgemeine Symbole

## 2.1 Allgemeine Sicherheitshinweise

### 2.1.1 Alle Hausgeräte

#### **Stromschlaggefahr durch spannungsführende Teile!**

- Wenn elektrische Komponenten fehlerhaft repariert werden, besteht Stromschlaggefahr!
- Das Gerät mindestens 60 Sekunden vor Beginn der Arbeiten vom Netz trennen.
- Nach der Reparatur muss eine Sicherheitsprüfung nach VDE 0701 oder länderspezifischen Vorschriften durchgeführt werden.

#### **Verletzungsgefahr durch scharfe Kanten!**

- Schutzhandschuhe tragen.

#### **Quetschgefahr während Reparatur-, Wartungs-, Fehlersuche- und Servicearbeiten durch schwere sich bewegende Bauteile**

- Schutzhandschuhe tragen.
- Schwere Bauteile gegen Herabfallen sichern.
- Körperteile nicht in sich bewegende Bauteile stecken.



#### **Gefährdung der Gerätesicherheit/-funktion!**

- Ausschließlich Originalersatzteile verwenden.

#### **Gefahr der Beschädigung elektrostatisch gefährdeter Bauteile (elektrostatische Entladungen)!**

- Die Module, einschließlich ihrer Anschlüsse und Leiterbahnen, keinesfalls berühren.

## Werkzeuge und Hilfsmittel

Bezeichnung	Details	Bilder
Schutztuch [00342013]	60 cm x 50 cm	
Torx-Bit TX20 [00340865]	6,3 mm (1/4")	
Spezialwerkzeug [00342180]		

## 4.1 Austauschen der Türdichtung

### Voraussetzung:

- ✔ Die Tür ist offen.

### 4.1.1 Ausbauen der Türdichtung

1. Die Türdichtung aus der Kerbe in der rechten und linken Ecke lösen.

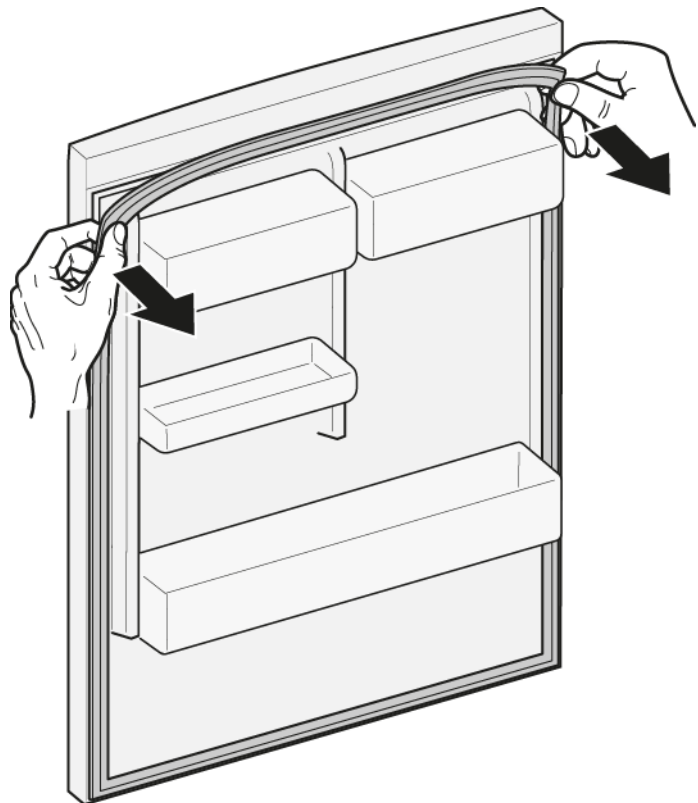

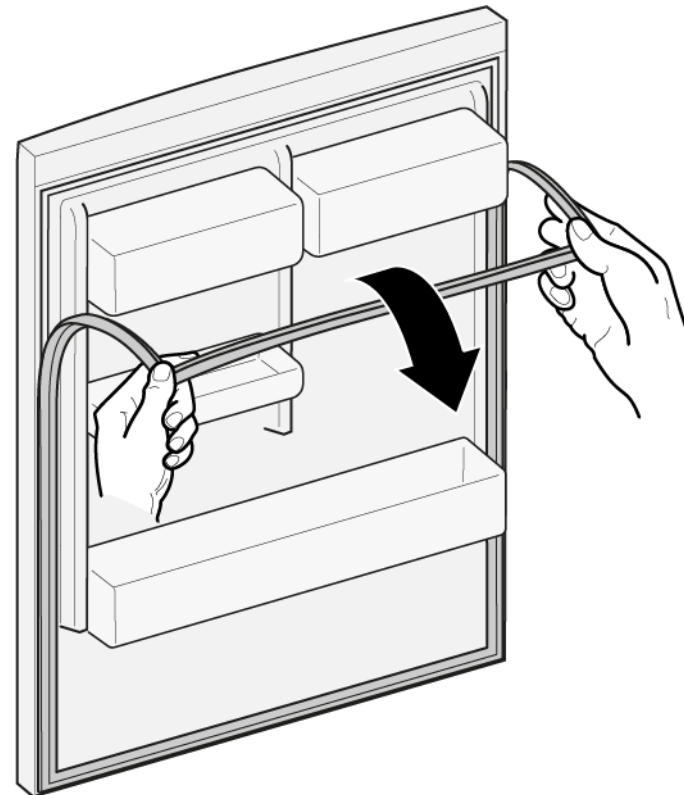

2. Die Türdichtung aus der Kerbe herausziehen.



- ➡ Die Türdichtung ist entfernt.

### 4.1.2 Einbauen der Türdichtung

	Die Dicke neuer Türdichtungen kann geringfügig von der Dicke alter Türdichtungen abweichen. Dies hat auf das Schließverhalten und die langfristige Funktion keinen Einfluss.
	Wenn das Gerät mit einstellbaren Scharnieren oder Scharnierbefestigungen ausgestattet ist, kann das Schließverhalten anschließend optimiert werden.
	Die kleinen seitlichen Löcher in der Türdichtung haben eine wichtige Funktion (für Lüftung erforderlich). Es handelt sich hierbei nicht um Produktionsfehler.

## Instandsetzen

1. Die Dichtungskerbe auf Beschädigungen überprüfen.

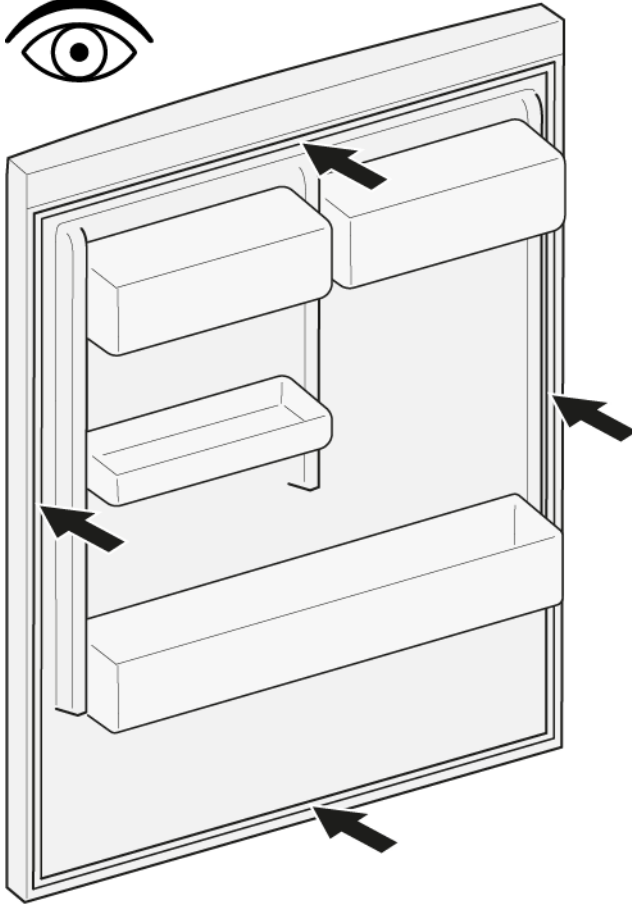

4. Die Dichtungsecken oben und unten in die Kerbe drücken.

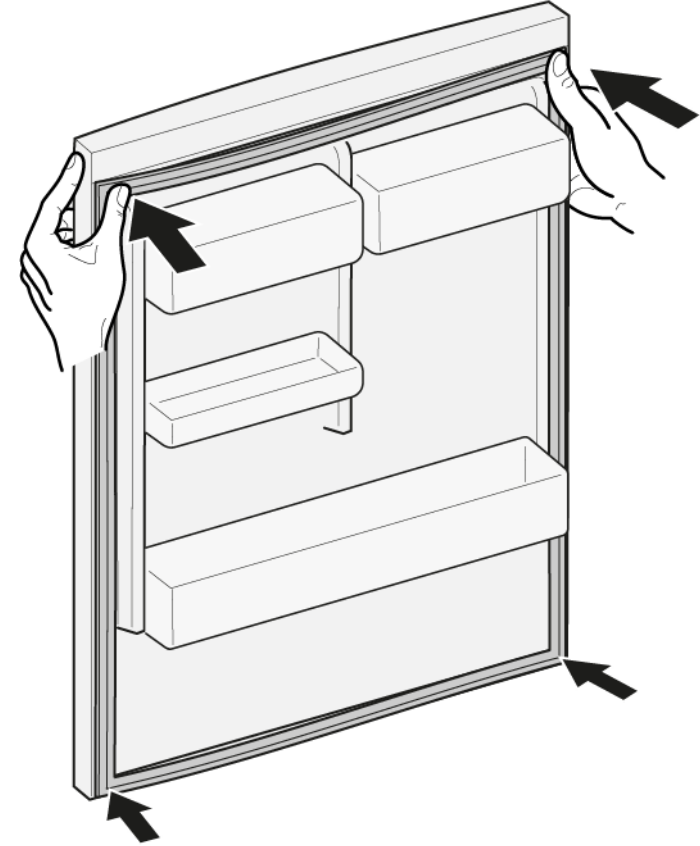

2.  Wenn die Dichtungskerbe beschädigt ist:
  - Den Kundendienst kontaktieren.

3.  Leichte Deformationen der Türdichtung sind normal und beeinträchtigen nicht die Funktion. Es wird empfohlen, die Türdichtung vor dem Einsetzen in das Gerät zu begradigen.

Die Türdichtung mit einem Haartrockner oder mit heißem Wasser erwärmen und von Hand in die richtige Form bringen.



## Instandsetzen

5. Die gesamte Dichtung Stück für Stück in die Kerbe drücken.

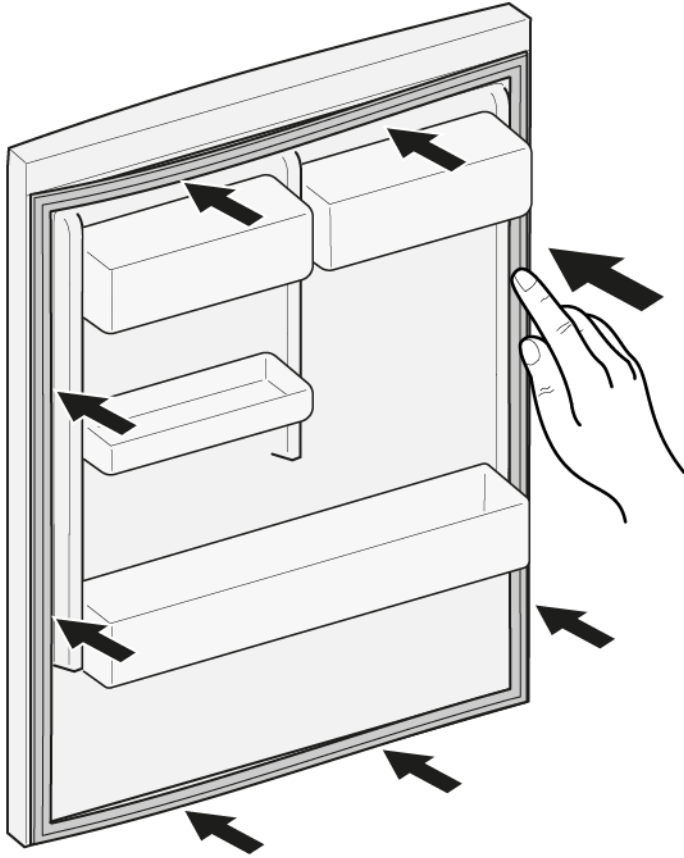

-  Die Türdichtung ist eingebaut.

## 4.2 Austauschen des Flachscharniers

### Spezielle Hilfsmittel:

🌀 Torx-Bit TX20      6,3 mm (1/4")      [00340865]

	<b>⚠️ WARNUNG</b>
	<p><b>Schwere, unhandliche Geräte!</b> Rücken- und Muskelverletzungen</p> <ul style="list-style-type: none"> <li>▶ Der Ausbau der Gerätetür sollte nur von geschulten Spezialisten durchgeführt werden.</li> <li>▶ Zum Bewegen des Geräts sind zwei Personen erforderlich.</li> <li>▶ Nur geeignete Werkzeuge und Vorrichtungen verwenden.</li> </ul>

	<b>⚠️ VORSICHT</b>
	<p><b>Scharfe Kanten!</b> Schnittverletzungen</p> <ul style="list-style-type: none"> <li>▶ Schutzhandschuhe tragen.</li> </ul>

	<b>⚠️ VORSICHT</b>
	<p><b>Offener Scharnierbereich!</b> Quetschen / Einklemmen der Finger</p> <ul style="list-style-type: none"> <li>▶ Nicht in den Scharnierbereich greifen.</li> <li>▶ Schutzhandschuhe tragen.</li> </ul>

	<b>⚠️ VORSICHT</b>
	<p><b>Risiko herabfallender Teile durch gelöste Schrauben!</b> Verletzungsgefahr durch herabfallende Teile.</p> <ul style="list-style-type: none"> <li>▶ Die Komponenten gegen Herunterfallen sichern.</li> </ul>

	<b>ACHTUNG</b>
	<p><b>Risiko herabfallender Teile durch gelöste Schrauben!</b> Gefahr der Beschädigung anderer Geräteteile bzw. von Beschädigungen im Haushalt des Kunden, z. B. des Bodens.</p> <ul style="list-style-type: none"> <li>▶ Die Komponenten gegen Herunterfallen sichern.</li> </ul>

### Voraussetzung:

- ✅ Das Gerät ist spannungsfrei.
- ✅ Die Möbeltür ist entfernt. Siehe Installationsanleitung.
- ✅ Die Tür ist offen.

## 4.2.1 Ausbauen des Flachscharniers

Darauf achten, dass die Scharniere beim Aus-/Einbau nicht geschlossen werden.

1. Die vier Scharnierabdeckungen entfernen.

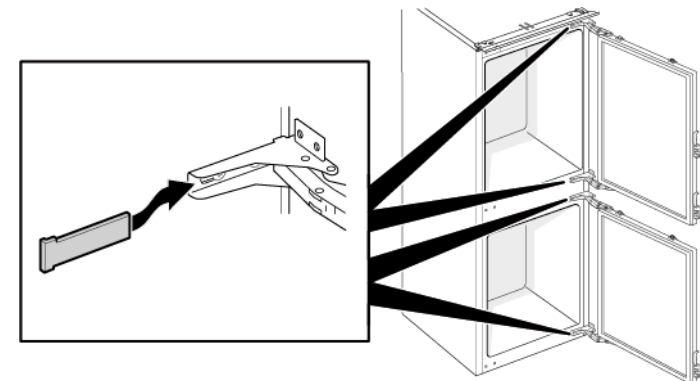

## Instandsetzen

2. 1. Die vier Schrauben lösen (1).  
2. Die obere Tür herausschieben und entfernen (2).

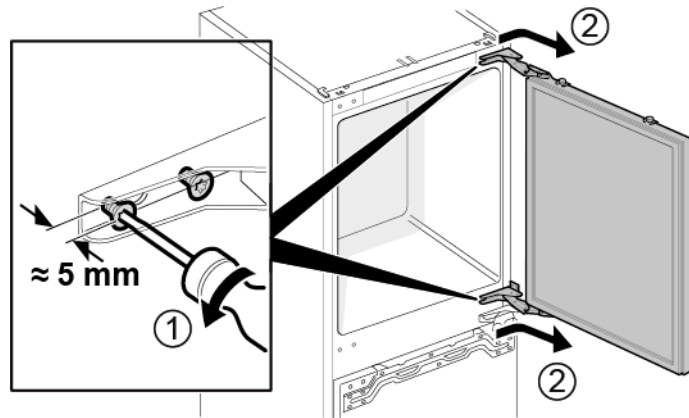

3. 1. Die vier Schrauben entfernen (1).  
2. Die Scharniere entfernen (2).

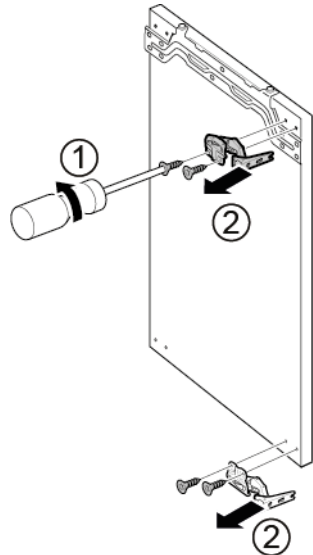

 Die oberen Türscharniere sind entfernt.

4. 1. Die vier Schrauben lösen (1).  
2. Die untere Tür herausschieben und entfernen (2).

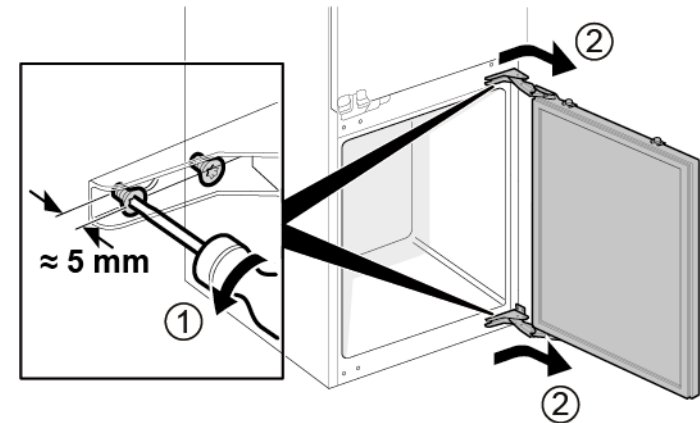

5. 1. Die vier Schrauben entfernen (1).  
2. Die Scharniere entfernen (2).

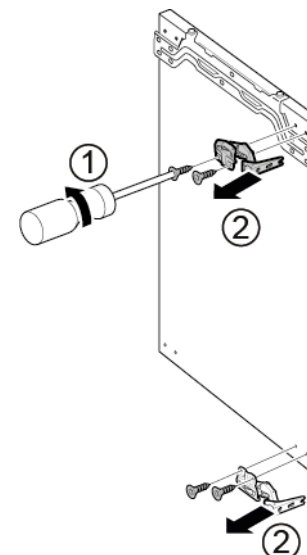

 Die unteren Türscharniere sind entfernt.

## 4.2.2 Einbauen des Flachscharniers

- ▶ Der Einbau erfolgt in umgekehrter Reihenfolge.

## 4.3 Austauschen des Schleppscharniers

### Spezielle Hilfsmittel:

🌀 Torx-Bit TX20      6,3 mm (1/4")      [00340865]

	<b>⚠️ WARNUNG</b>
	<p><b>Schwere, unhandliche Geräte!</b> Rücken- und Muskelverletzungen</p> <ul style="list-style-type: none"> <li>▶ Der Ausbau der Gerätetür sollte nur von geschulten Spezialisten durchgeführt werden.</li> <li>▶ Zum Bewegen des Geräts sind zwei Personen erforderlich.</li> <li>▶ Nur geeignete Werkzeuge und Vorrichtungen verwenden.</li> </ul>

	<b>⚠️ VORSICHT</b>
	<p><b>Scharfe Kanten!</b> Schnittverletzungen</p> <ul style="list-style-type: none"> <li>▶ Schutzhandschuhe tragen.</li> </ul>

	<b>⚠️ VORSICHT</b>
	<p><b>Risiko herabfallender Teile durch gelöste Schrauben!</b> Verletzungsgefahr durch herabfallende Teile.</p> <ul style="list-style-type: none"> <li>▶ Die Komponenten gegen Herunterfallen sichern.</li> </ul>

	<b>⚠️ ACHTUNG</b>
	<p><b>Risiko herabfallender Teile durch gelöste Schrauben!</b> Gefahr der Beschädigung anderer Geräteteile bzw. von Beschädigungen im Haushalt des Kunden, z. B. des Bodens.</p> <ul style="list-style-type: none"> <li>▶ Die Komponenten gegen Herunterfallen sichern.</li> </ul>

### Voraussetzung:

- ✔ Das Gerät ist spannungsfrei.
- ✔ Die Möbeltür und die Gerätetür sind getrennt. Siehe Installationsanleitung.

## 4.3.1 Ausbauen des Schleppscharniers

1. Die beiden Schrauben herausschrauben (1).
2. Das obere Scharnier der oberen Tür entfernen (2).
3. Die obere Tür entfernen (3).
4. Die beiden Schrauben herausschrauben (4).
5. Das obere Scharnier der unteren Tür entfernen (5).
6. Die untere Tür entfernen (6).

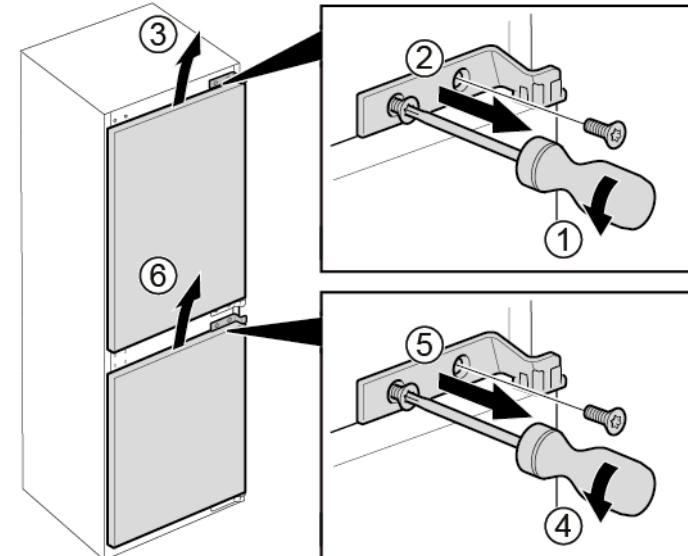

2. 1. Die vier Schrauben entfernen (1).
2. Die unteren Scharniere entfernen (2).

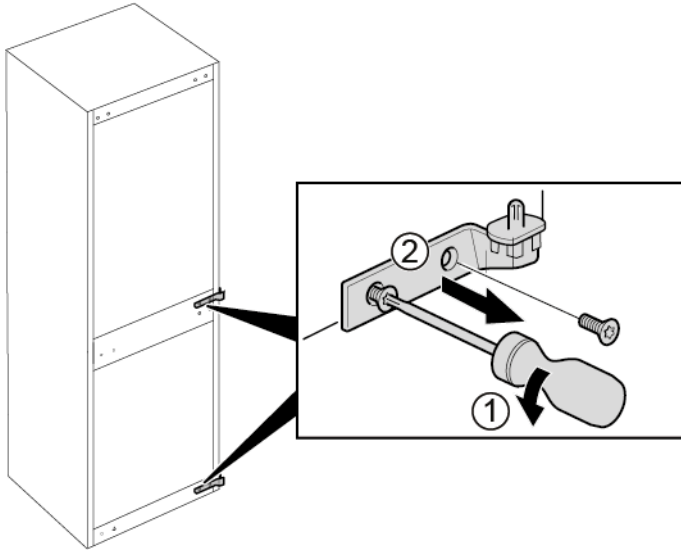

➡ Die Scharniere sind entfernt.

### 4.3.2 Einbauen des Schleppscharniers

- ▶ Der Einbau erfolgt in umgekehrter Reihenfolge.

## 4.4 Austauschen des Türabstellers

### Voraussetzung:

- ✔ Die Tür ist offen.

### 4.4.1 Ausbauen des Türabstellers

- ▶ Den Türabsteller anheben.

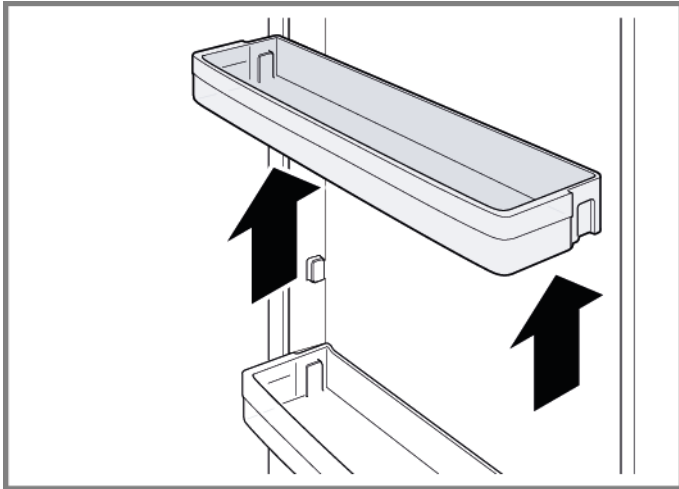

- ➡ Der Türabsteller ist entfernt.

### 4.4.2 Einbauen des Türabstellers

- ▶ Der Einbau erfolgt in umgekehrter Reihenfolge.

## 4.5 Austauschen der Ablage

### Voraussetzung:

- ✔ Die Tür ist offen.

### 4.5.1 Ausbauen der Ablage

- ▶ Die Ablage herausziehen.

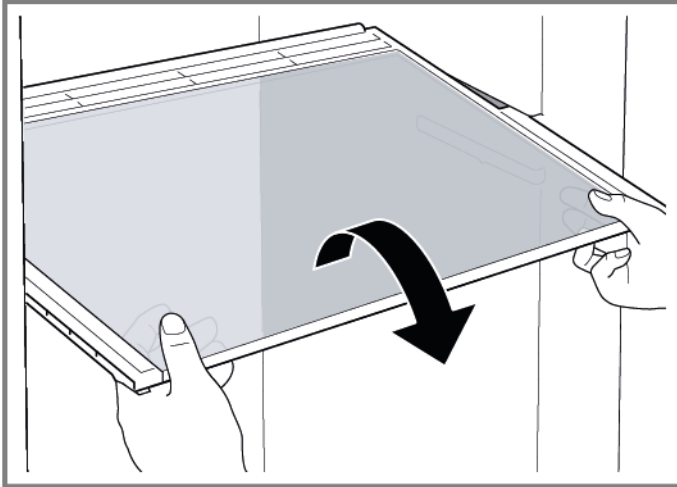

- ➡ Die Ablage ist entfernt.

### 4.5.2 Einbauen der Ablage

- ▶ Der Einbau erfolgt in umgekehrter Reihenfolge.



## 4.6 Austauschen der ausziehbaren Ablage

### Voraussetzung:

- ✔ Die Tür ist offen.

### 4.6.1 Ausbauen der ausziehbaren Ablage

1. Die ausziehbare Ablage herausziehen, bis die Rastnase ausrastet.

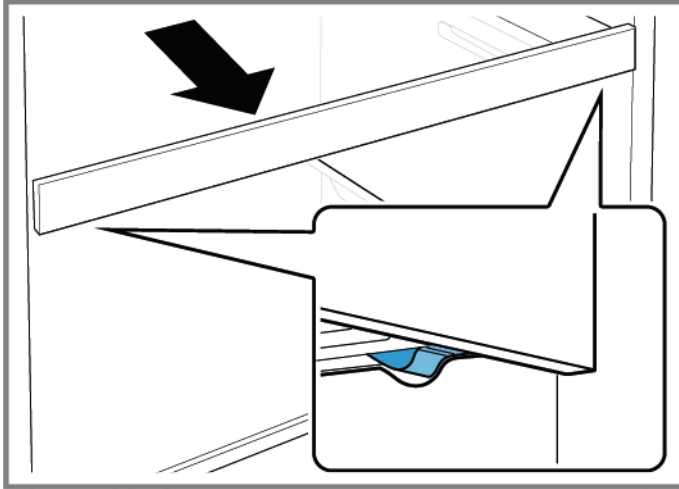

2. Die ausziehbare Ablage absenken und seitlich herausschwenken.
3. ⬅ Die ausziehbare Ablage ist entfernt.

### 4.6.2 Einbauen der ausziehbaren Ablage

- ▶ Der Einbau erfolgt in umgekehrter Reihenfolge.

## 4.7 Austauschen der Gefrierfachablage

### Voraussetzung:

- ✔ Die Tür ist offen.

### 4.7.1 Ausbauen der Gefrierfachablage

- ▶ Die Gefrierfachablage herausziehen.

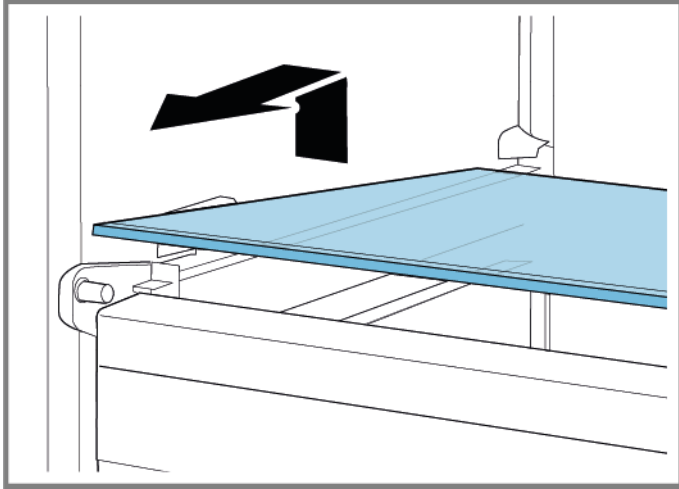

- ➡ Die Gefrierfachablage ist entfernt.

### 4.7.2 Einbauen der Gefrierfachablage

- ▶ Der Einbau erfolgt in umgekehrter Reihenfolge.

## 4.8 Austauschen des Gefriergutbehälters

### Voraussetzung:

- ✔ Die Tür ist offen.

### 4.8.1 Ausbauen des Gefriergutbehälters

- ▶ 1. Den Gefriergutbehälter vollständig herausziehen (1).
- ▶ 2. Den Gefriergutbehälter entfernen (2).

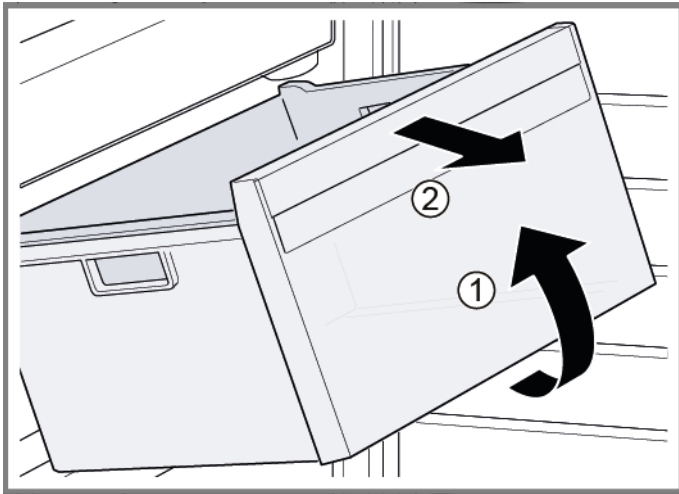

- ➡ Der Gefriergutbehälter ist entfernt.

### 4.8.2 Einbauen des Gefriergutbehälters

- ▶ Der Einbau erfolgt in umgekehrter Reihenfolge.

## 4.9 Austauschen des Obst- und Gemüsebehälters

### Voraussetzung:

- ✔ Die Tür ist offen.

### 4.9.1 Ausbauen des Obst- und Gemüsebehälters

- ▶ 1. Den Behälter vollständig herausziehen (1).
- ▶ 2. Den Behälter entfernen (2).

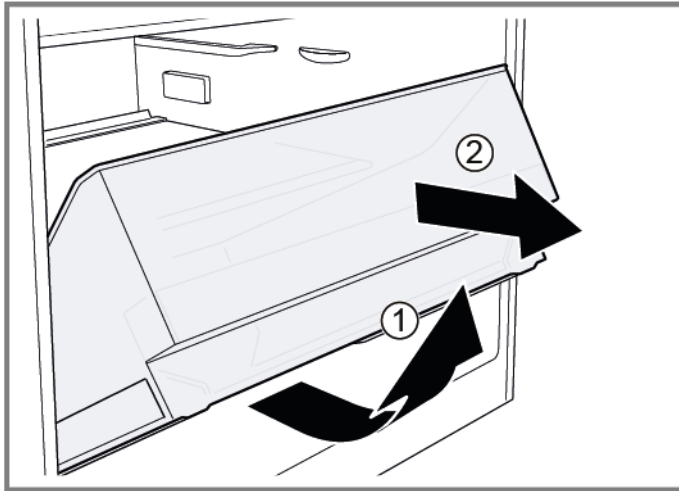

- ➡ Der Behälter ist entfernt.

### 4.9.2 Einbauen des Obst- und Gemüsebehälters

- ▶ Der Einbau erfolgt in umgekehrter Reihenfolge.

### 4.10 Austauschen der Trennplatte und der Abdeckung des Obst- und Gemüsebehälters

#### Voraussetzung:

- ✔ Die Tür ist offen.

#### 4.10.1 Ausbauen der Trennplatte und der Abdeckung des Obst- und Gemüsebehälters

1. Die Glasplatte von der Trennplatte entfernen.

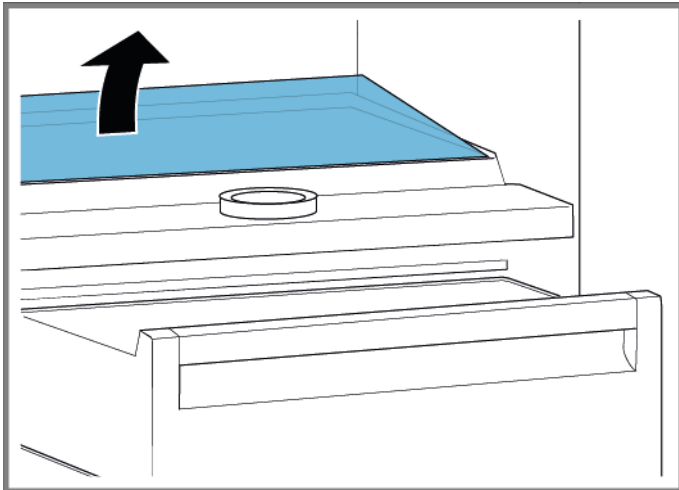

2. [Den Obst- und Gemüsebehälter entnehmen.](#) → Seite 236

3. 1. Auf beiden Trennplattenseiten den Hebel an der Unterseite drücken (1).
2. Die Trennplatte nach vorn ziehen (2).

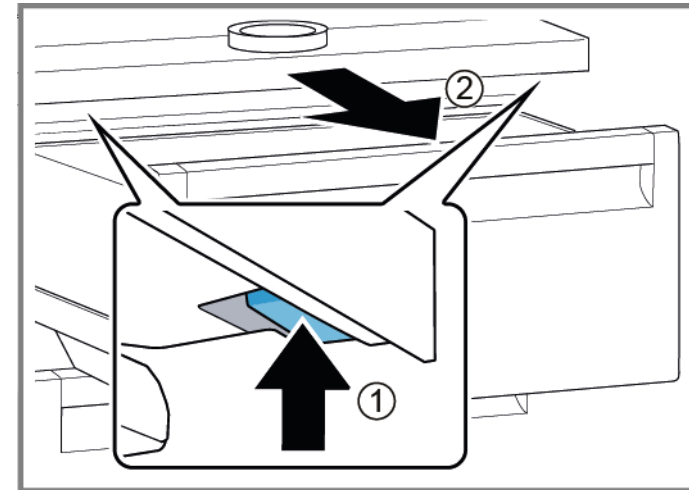

4. Die Trennplatte anheben und seitlich herausschwenken.
  - ➡ Die Trennplatte ist entfernt.
5. 1. Die Abdeckung des Obst- und Gemüsebehälters anheben.
2. Die Abdeckung des Obst- und Gemüsebehälters nach vorn ziehen und seitlich herausschwenken.
  - ➡ Die Abdeckung des Obst- und Gemüsebehälters ist entfernt.

#### 4.10.2 Einbauen der Trennplatte und der Abdeckung des Obst- und Gemüsebehälters

- ▶ Der Einbau erfolgt in umgekehrter Reihenfolge.

## 4.11 Austauschen des Frischkühlbehälters

### Voraussetzung:

- ✔ Die Tür ist offen.

### 4.11.1 Ausbauen des Frischkühlbehälters

- ▶ 1. Den Frischkühlbehälter nach vorn neigen (1).
- ▶ 2. Den Frischkühlbehälter entfernen (2).

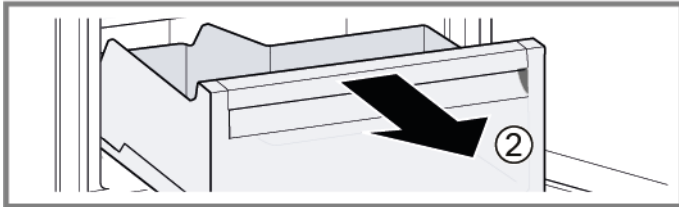
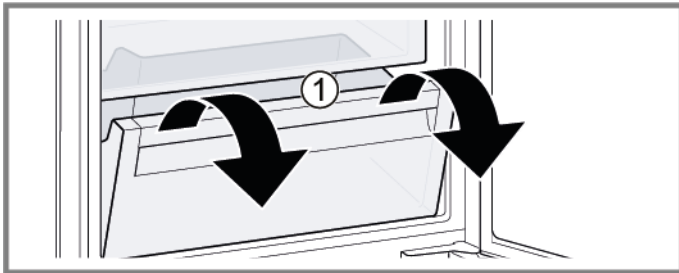

➡ Der Frischkühlbehälter ist entfernt.

### 4.11.2 Einbauen des Frischkühlbehälters

- ▶ Der Einbau erfolgt in umgekehrter Reihenfolge.

## 4.12 Austauschen des ausziehbaren Behälters

### Voraussetzung:

- ✔ Die Tür ist offen.

### 4.12.1 Ausbauen des ausziehbaren Behälters

- ▶ 1. Den ausziehbaren Behälter nach vorn neigen (1).
- ▶ 2. Den ausziehbaren Behälter entfernen (2).

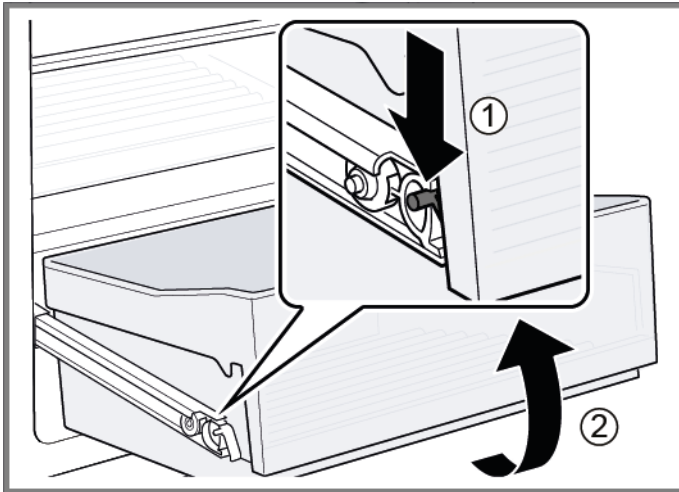



➡ Der ausziehbare Behälter ist entfernt.

### 4.12.2 Einbauen des ausziehbaren Behälters

- ▶ Der Einbau erfolgt in umgekehrter Reihenfolge.

## 4.13 Austauschen des LED-Strahlers

### Spezielle Hilfsmittel:

-  Spezialwerkzeug [00342180]
-  Schlitzschraubendreher Klinge 2,4 mm x 0,4 mm x 60 mm, im Set [00341820]

 Ihr Gerät ist mit einer wartungsfreien LED-Beleuchtung ausgestattet. Reparaturen an dieser Beleuchtung dürfen nur vom Kundendienst oder von autorisierten Fachkräften ausgeführt werden!

 **GEFAHR**  
**Stromschlaggefahr durch spannungsführende Teile!**  
 Lebensgefahr durch Stromschlag bei unsachgemäßer Reparatur

- ▶ Elektroteile sollten von einer Elektrofachkraft repariert werden.
- ▶ Nach der Reparatur muss eine Sicherheitsprüfung nach VDE 0701 oder länderspezifischen Vorschriften durchgeführt werden.



 **GEFAHR**  
**Stromschlaggefahr durch spannungsführende Teile!**  
 Tod durch Stromschlag

- ▶ Gerät mindestens 60 Sekunden vor Reparaturbeginn vom Netz trennen.

 **VORSICHT**  
**Scharfe Kanten!**  
 Schnittverletzungen

- ▶ Schutzhandschuhe tragen.

### Voraussetzung:

-  Das Gerät ist spannungsfrei.
-  Die Tür ist offen.
-  Die Kühlraumablagen sind entfernt.

## 4.13.1 Ausbauen des LED-Strahlers

1. Die Abdeckung des LED-Strahlers lösen.

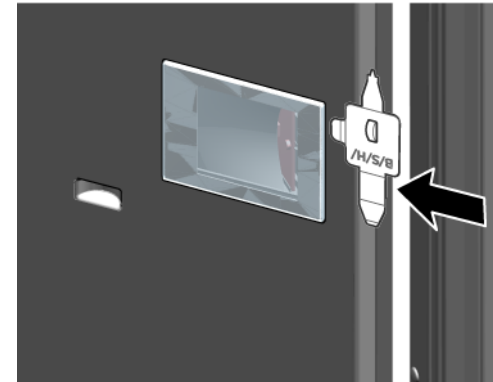

2. Die Abdeckung des LED-Strahlers nach innen ziehen und gleichzeitig nach vorn schieben.

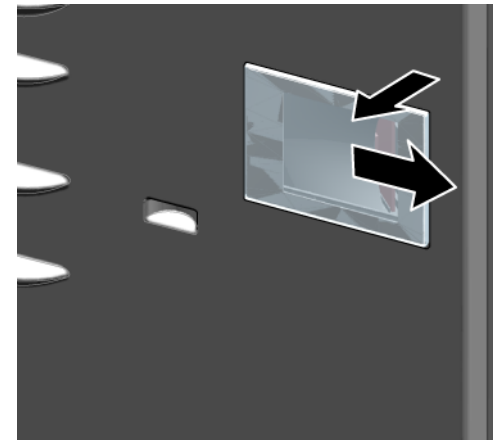



3. Das LED-Strahler-Modul lösen.

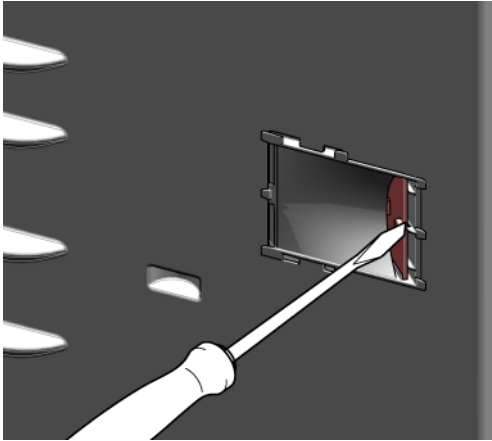

4. Den elektrischen Anschluss des LED-Strahlers trennen.

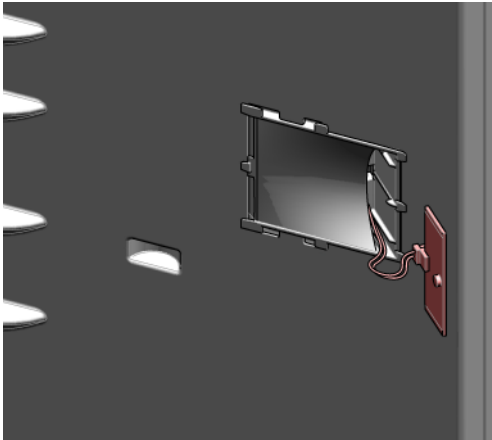





- ➡ Der LED-Strahler ist entfernt.

### 4.13.2 Einbauen des LED-Strahlers

- ▶ Der Einbau erfolgt in umgekehrter Reihenfolge.

# Υποδείξεις επισκευής - Ψυγειοκαταψύκτης

 <b>Σχετικά με αυτό το έγγραφο</b> .....	<b>243</b>
1.1 Σημαντικές πληροφορίες .....	243
1.1.1 Σκοπός.....	243
1.2 Επεξήγηση συμβόλων .....	243
1.2.1 Επίπεδα κινδύνου .....	243
1.2.2 Σύμβολα κινδύνου.....	243
1.2.3 Δομή των προειδοποιήσεων .....	244
1.2.4 Γενικά σύμβολα .....	244
 <b>Ασφάλεια</b> .....	<b>245</b>
2.1 Γενικές οδηγίες ασφαλείας .....	245
2.1.1 Όλες οι οικιακές συσκευές .....	245
 <b>Εργαλεία και βοηθήματα</b> .....	<b>246</b>
 <b>Επισκευή</b> .....	<b>247</b>
4.1 Αντικατάσταση στεγανοποιητικού πόρτας .....	247
4.1.1 Αφαίρεση στεγανοποιητικού πόρτας.....	247
4.1.2 Τοποθέτηση στεγανοποιητικού πόρτας .....	247
4.2 Αντικατάσταση επιπέδου μεντεσέ .....	250
4.2.1 Αφαίρεση επιπέδου μεντεσέ .....	250
4.2.2 Τοποθέτηση επιπέδου μεντεσέ .....	252
4.3 Αντικατάσταση συρόμενου μεντεσέ.....	253
4.3.1 Αφαίρεση συρόμενου μεντεσέ.....	253
4.3.2 Τοποθέτηση συρόμενου μεντεσέ.....	254
4.4 Αντικατάσταση ραφιού πόρτας .....	255
4.4.1 Αφαίρεση ραφιού πόρτας .....	255
4.4.2 Τοποθέτηση ραφιού πόρτας .....	255
4.5 Αντικατάσταση ραφιού .....	256
4.5.1 Αφαίρεση ραφιού .....	256
4.5.2 Τοποθέτηση ραφιού .....	256
4.6 Αντικατάσταση τηλεσκοπικού ραφιού.....	257
4.6.1 Αφαίρεση τηλεσκοπικού ραφιού .....	257
4.6.2 Τοποθέτηση τηλεσκοπικού ραφιού.....	257
4.7 Αντικατάσταση ραφιού χώρου κατάψυξης .....	258
4.7.1 Αφαίρεση ραφιού χώρου κατάψυξης .....	258
4.7.2 Τοποθέτηση ραφιού χώρου κατάψυξης .....	258

4.8 Αντικατάσταση συρταριού κατεψυγμένων τροφίμων.....	259
4.8.1 Αφαίρεση συρταριού κατεψυγμένων τροφίμων .....	259
4.8.2 Τοποθέτηση συρταριού κατεψυγμένων τροφίμων .....	259
4.9 Αντικατάσταση συρταριού φρούτων και λαχανικών .....	260
4.9.1 Αφαίρεση συρταριού φρούτων και λαχανικών .....	260
4.9.2 Τοποθέτηση συρταριού φρούτων και λαχανικών .....	260
4.10 Αντικατάσταση διαχωριστικού και καλύμματος συρταριού φρούτων και λαχανικών .....	261
4.10.1 Αφαίρεση διαχωριστικού και καλύμματος συρταριού φρούτων και λαχανικών .....	261
4.10.2 Τοποθέτηση διαχωριστικού και καλύμματος συρταριού φρούτων και λαχανικών .....	261
4.11 Αντικατάσταση συρταριού cool-fresh .....	262
4.11.1 Αφαίρεση συρταριού cool-fresh .....	262
4.11.2 Τοποθέτηση συρταριού cool-fresh .....	262
4.12 Αντικατάσταση τηλεσκοπικού συρταριού .....	263
4.12.1 Αφαίρεση τηλεσκοπικού συρταριού .....	263
4.12.2 Τοποθέτηση τηλεσκοπικού συρταριού .....	263
4.13 Αντικατάσταση προβολέα LED.....	264
4.13.1 Αφαίρεση spot φωτισμού LED .....	264
4.13.2 Τοποθέτηση spot φωτισμού LED.....	265

# **i** Σχετικά με αυτό το έγγραφο

## 1.1 Σημαντικές πληροφορίες

### 1.1.1 Σκοπός

Αυτές οι συμβουλές επισκευών υποστηρίζουν τους καταναλωτές στην επισκευή των συσκευών από τους ίδιους, σύμφωνα με τον ισχύοντα κανονισμό οικολογικού σχεδιασμού (από τις 03/2021).





Περιέχουν πληροφορίες για την αντικατάσταση ορισμένων ανταλλακτικών, συμπεριλαμβανομένων προειδοποιήσεων και κινδύνων.

Σε περίπτωση ερωτήσεων, επικοινωνήστε με το τμήμα εξυπηρέτησης πελατών της εταιρείας μας. Φέρουμε ευθύνη για τις ζημιές εάν οι συμβουλές επισκευής έχουν ακολουθηθεί σωστά.

## 1.2 Επεξήγηση συμβόλων

### 1.2.1 Επίπεδα κινδύνου

Τα επίπεδα προειδοποίησης ασφάλειας αποτελούνται από ένα σύμβολο και μια λέξη. Η λέξη προειδοποίησης προσδιορίζει τη σοβαρότητα του κινδύνου.





Επίπεδο προειδοποίησης	Σημασία
 <b>ΚΙΝΔΥΝΟΣ</b>	Η μη τήρηση του προειδοποιητικού μηνύματος θα οδηγήσει σε θάνατο ή σε σοβαρούς τραυματισμούς.
 <b>ΠΡΟΕΙΔΟΠΟΙΗΣΗ</b>	Η μη τήρηση του προειδοποιητικού μηνύματος θα μπορούσε να οδηγήσει σε θάνατο ή σε σοβαρούς τραυματισμούς.
 <b>ΠΡΟΣΟΧΗ</b>	Η μη τήρηση του προειδοποιητικού μηνύματος θα μπορούσε να οδηγήσει σε μικρούς τραυματισμούς.
 <b>ΠΡΟΣΟΧΗ!</b>	Η μη τήρηση του προειδοποιητικού μηνύματος θα μπορούσε να οδηγήσει σε υλικές ζημιές της ιδιοκτησίας.

Πίνακας 1: Επίπεδα κινδύνου





### 1.2.2 Σύμβολα κινδύνου

Τα σύμβολα κινδύνου είναι συμβολικές αναπαραστάσεις που δίνουν μια ένδειξη για το είδος του κινδύνου.

Τα ακόλουθα σύμβολα κινδύνου χρησιμοποιούνται στο παρόν έγγραφο:

Σύμβολο κινδύνου	Σημασία
	Γενικό προειδοποιητικό μήνυμα
	Κίνδυνος από ηλεκτρική τάση
	Κίνδυνος έκρηξης
	Κίνδυνος κοψίματος

## **i** Σχετικά με αυτό το έγγραφο

Σύμβολο κινδύνου	Σημασία
	Κίνδυνος σύνθλιψης
	Κίνδυνος από καυτές επιφάνειες
	Κίνδυνος από ισχυρό μαγνητικό πεδίο
	Κίνδυνος από μη ιονίζουσα ακτινοβολία

Πίνακας 2: Σύμβολα κινδύνου

### 1.2.3 Δομή των προειδοποιήσεων

.Οι προειδοποιήσεις σε αυτό το έγγραφο έχουν μια τυποποιημένη εμφάνιση και μια τυποποιημένη δομή.

	<b>⚠ ΚΙΝΔΥΝΟΣ</b>
<b>Είδος και πηγή κινδύνου!</b>	
Πιθανές συνέπειες εάν αγνοήσετε τον κίνδυνο/την προειδοποίηση.	
▶ Μέτρα και απαγορεύσεις για την πρόληψη του κινδύνου.	

Το παρακάτω παράδειγμα δείχνει μια προειδοποίηση που προειδοποιεί κατά της ηλεκτροπληξίας λόγω ηλεκτροφόρων μερών. Αναφέρεται το μέτρο για την αποφυγή του κινδύνου.

	<b>⚠ ΚΙΝΔΥΝΟΣ</b>
<b>Κίνδυνος ηλεκτροπληξίας λόγω ηλεκτροφόρων μερών!</b>	
Θάνατος από ηλεκτροπληξία	
▶ Αποσυνδέετε τις συσκευές από την παροχή ηλεκτρικού ρεύματος τουλάχιστον 60 δευτερόλεπτα πριν ξεκινήσετε τις επισκευές.	

### 1.2.4 Γενικά σύμβολα

Τα ακόλουθα γενικά σύμβολα χρησιμοποιούνται στο παρόν έγγραφο:

Γεν. σύμβολο	Σημασία
	Ταυτοποίηση μιας ειδικής συμβουλής (κειμένου ή/και γραφικών)
	Ταυτοποίηση μιας ειδικής συμβουλής (μόνο κειμένου)
	Ταυτοποίηση συνδέσμου ή εκπαιδευτικού βίντεο
	Ταυτοποίηση απαραίτητων εργαλείων
	Ταυτοποίηση απαραίτητων προϋποθέσεων
	Ταυτοποίηση μιας συνθήκης (αν ..., κατόπιν ...)
	Ταυτοποίηση αποτελέσματος
[Έναρξη]	Ταυτοποίηση ενός πλήκτρου ή κουμπιού
[00123456]	Ταυτοποίηση ενός κωδικού ανταλλακτικού
Κατάσταση	Ταυτοποίηση εμφανιζόμενου κειμένου/ παραθύρου (στην οθόνη της συσκευής)

Πίνακας 3: Γενικά σύμβολα

## 2.1 Γενικές οδηγίες ασφαλείας

### 2.1.1 Όλες οι οικιακές συσκευές

#### **Κίνδυνος ηλεκτροπληξίας λόγω ηλεκτροφόρων μερών!**

- Τα σφάλματα από επισκευές σε ηλεκτρικά εξαρτήματα μπορεί να προκαλέσουν ηλεκτροπληξία!
- Αποσυνδέστε τη συσκευή από την πρίζα για τουλάχιστον 60 δευτερόλεπτα πριν από την έναρξη των εργασιών.
- Μετά την επισκευή πραγματοποιήστε έλεγχο ασφαλείας σύμφωνα με το VDE 0701 ή κανονισμούς της συγκεκριμένης χώρας.

#### **Κίνδυνος τραυματισμού από κοφτερές άκρες!**

- Φοράτε προστατευτικά γάντια.

#### **Κίνδυνος σύνθλιψης κατά την επισκευή, συντήρηση, αντιμετώπιση προβλημάτων και το σέρβις από βαριά και κινούμενα μέρη**

- Φοράτε προστατευτικά υποδήματα.
- Ασφαλίστε τα βαριά μέρη από πτώση.
- Μην προσαρτάτε μέρη του πλαισίου στα κινούμενα μέρη.



#### **Κίνδυνος για την ασφάλεια/τη λειτουργία της συσκευής!**

- Χρησιμοποιείτε μόνο γνήσια ανταλλακτικά.

#### **Κίνδυνος πρόκλησης βλάβης σε μέρη ευαίσθητα στον στατικό ηλεκτρισμό (ESDs)!**

- Μην αγγίζετε τις μονάδες, συμπεριλαμβανομένων των συνδέσεων και των αγωγών των πλακετών.

## Εργαλεία και βοηθήματα

Όνομασία	Λεπτομέριες	Εικόνες
Πανάκι προστασίας [00342013]	60 cm x 50 cm	
Μύτη Torx TX20 [00340865]	6,3 mm (1/4")	
Ειδικό εργαλείο [00342180]		

## 4.1 Αντικατάσταση στεγανοποιητικού πόρτας

### Προϋπόθεση:

- ✔ Η πόρτα είναι ανοιχτή.

### 4.1.1 Αφαίρεση στεγανοποιητικού πόρτας

1. Απελευθερώστε το στεγανοποιητικό πόρτας από την εγκοπή στη δεξιά και αριστερή γωνία.

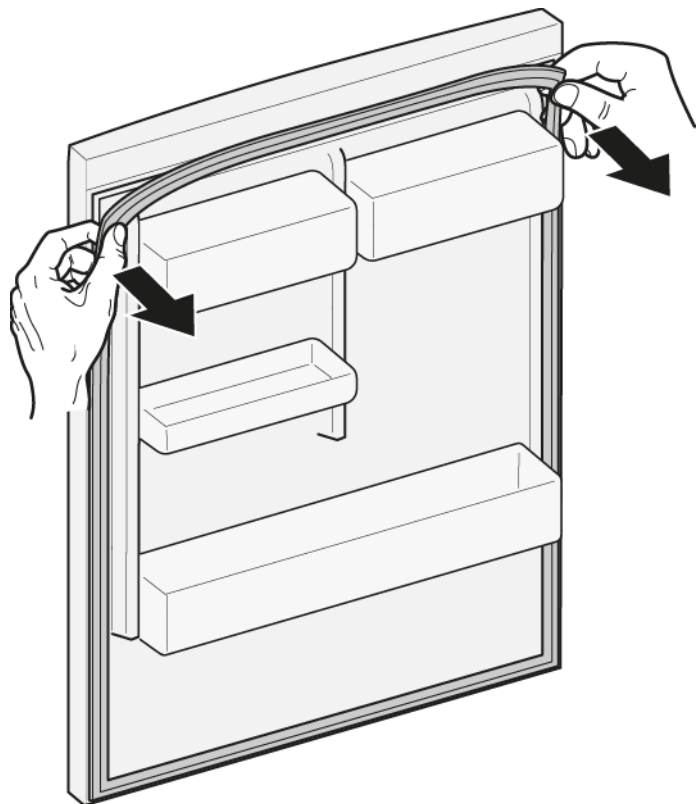

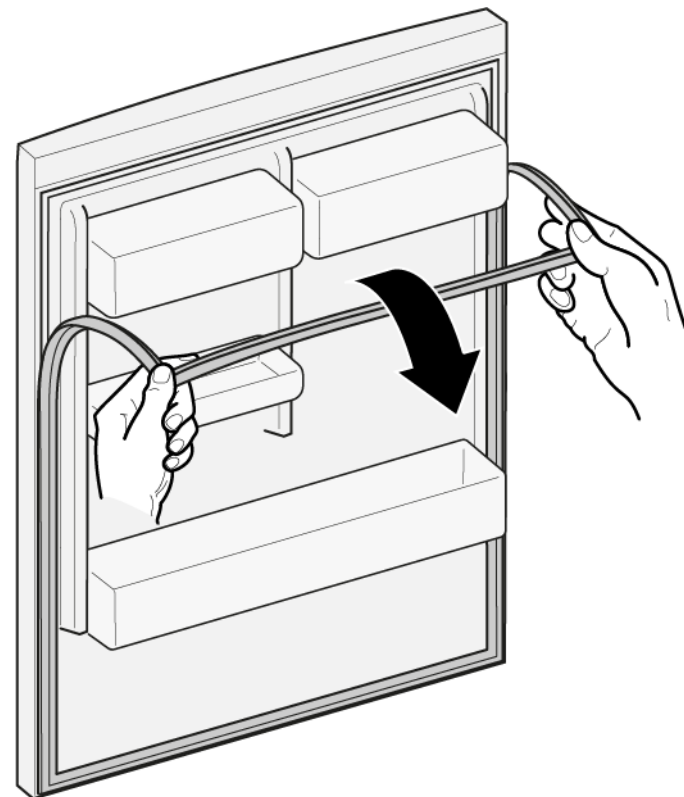

2. Τραβήξτε το στεγανοποιητικό πόρτας έξω από την εγκοπή.



- ➡ Το στεγανοποιητικό της πόρτας έχει αφαιρεθεί.

### 4.1.2 Τοποθέτηση στεγανοποιητικού πόρτας

	Το πάχος του νέου στεγανοποιητικού πόρτας μπορεί να αποκλίνει ελαφρώς από το πάχος του παλαιού στεγανοποιητικού πόρτας. Αυτό δεν θα επηρεάσει τη συμπεριφορά κλεισίματος και τη μακροπρόθεσμη λειτουργία.
	Εάν η συσκευή σας έχει προσαρμοζόμενους μεντεσέδες ή προσαρτήματα μεντεσέ, μπορεί να βελτιστοποιήσετε τη συμπεριφορά κλεισίματος αργότερα.
	Οι μικρές οπές πλευρικά στο στεγανοποιητικό της πόρτας είναι λειτουργικές (απαραίτητες για τον αερισμό). Δεν είναι κατασκευαστικά ελαττώματα.

1. Ελέγξτε την εγκοπή για το στεγανοποιητικό για ζημιές.

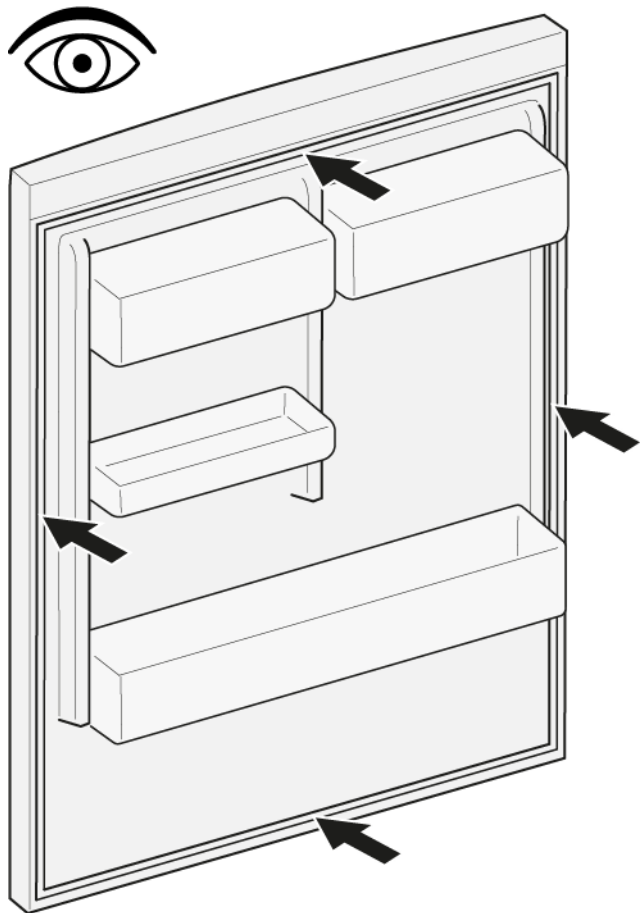

4. Πιέστε τις γωνίες του στεγανοποιητικού επάνω και κάτω στην εγκοπή.

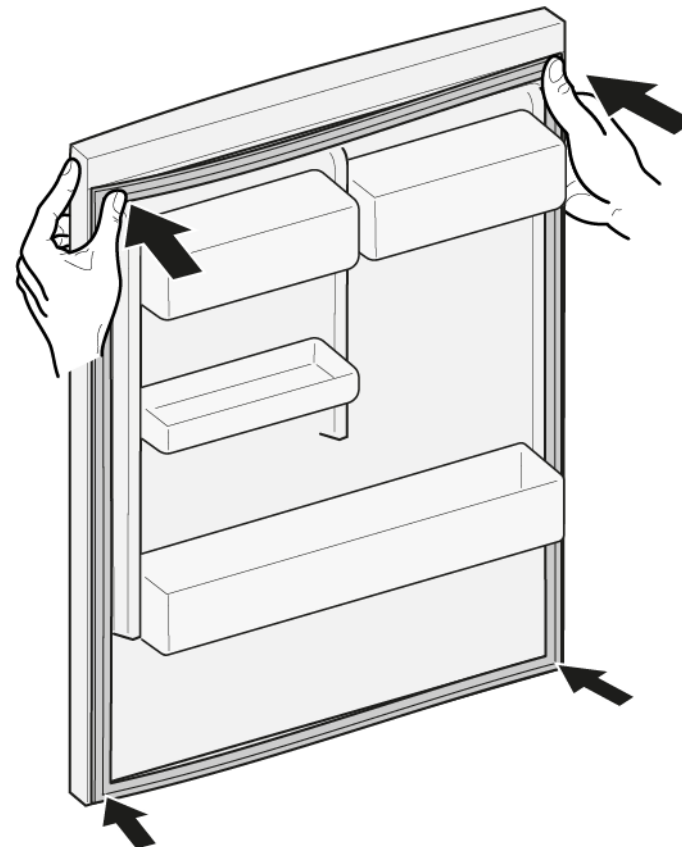

2. ⓘ Εάν η εγκοπή για στεγανοποιητικό είναι κατεστραμμένη.  
- Επικοινωνήστε με την εξυπηρέτηση πελατών.

3. ⓘ Η ελαφριά παραμόρφωση του στεγανοποιητικού της πόρτας είναι φυσιολογική και δεν επηρεάζει τη λειτουργία της. Συνιστάται να ισιώνετε το στεγανοποιητικό της πόρτας πριν την τοποθετήσετε στη συσκευή.

Θερμάνετε το στεγανοποιητικό της πόρτας με πιστολάκι ή ζεστό νερό και αλλάξτε το σχήμα του με το χέρι.



5. Πιέστε ολόκληρο το στεγανοποιητικό βήμα βήμα στο εσωτερικό της εγκοπής.

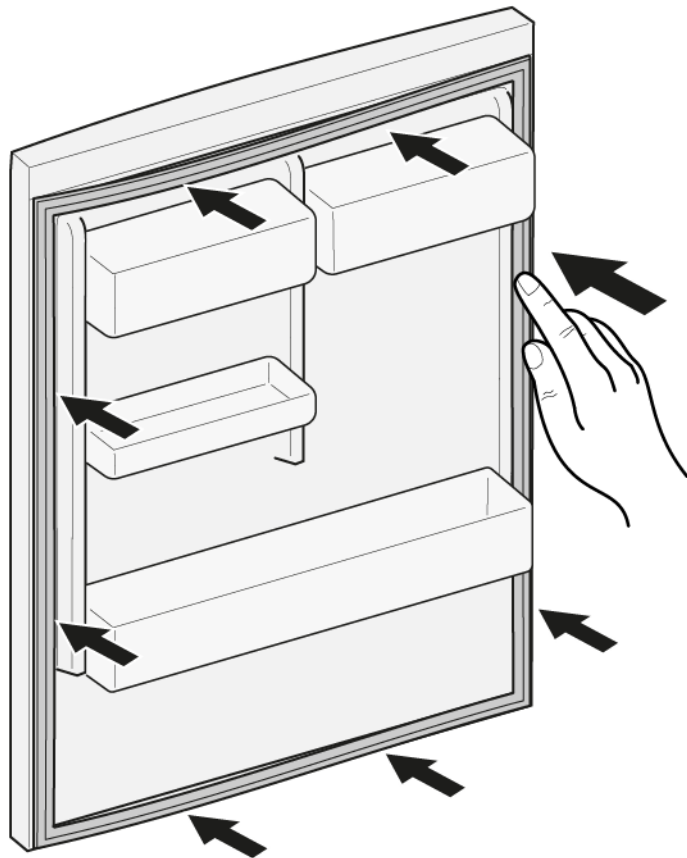

-  Το στεγανοποιητικό της πόρτας τοποθετήθηκε.

## 4.2 Αντικατάσταση επίπεδου μεντεσέ

Ειδικά βοηθητικά μέσα:

Μύτη Torx TX20 6,3 mm (1/4") [00340865]

	<b>ΠΡΟΕΙΔΟΠΟΙΗΣΗ</b>
	<p><b>Βαριές, ογκώδεις συσκευές!</b> Τραυματισμοί μέσης και μυών</p> <ul style="list-style-type: none"> <li>▶ Η διαδικασία αφαίρεσης της πόρτας της συσκευής πρέπει να εκτελείται μόνο από εκπαιδευμένους ειδικούς.</li> <li>▶ Η μετακίνηση της συσκευής πρέπει να εκτελείται από δύο άτομα.</li> <li>▶ Χρησιμοποιείτε μόνο κατάλληλα εργαλεία και εξοπλισμό.</li> </ul>

	<b>ΠΡΟΣΟΧΗ</b>
	<p><b>Αιχμηρές ακμές!</b> Τραυματισμοί από κοπή</p> <ul style="list-style-type: none"> <li>▶ Φοράτε προστατευτικά γάντια.</li> </ul>

	<b>ΠΡΟΣΟΧΗ</b>
	<p><b>Ανοίξτε την περιοχή με τους μεντεσέδες!</b> Σύνθλιψη/παγίδευση δακτύλων</p> <ul style="list-style-type: none"> <li>▶ Μην αγγίζετε την περιοχή με τους μεντεσέδες.</li> <li>▶ Φοράτε προστατευτικά γάντια.</li> </ul>

	<b>ΠΡΟΣΟΧΗ</b>
	<p><b>Κίνδυνοι από πτώση μερών εξαιτίας χαλαρών βιδών!</b> Τραυματισμός εξαιτίας πτώσης τμημάτων.</p> <ul style="list-style-type: none"> <li>▶ Ασφαλίστε τα εξαρτήματα από πτώση.</li> </ul>

	<b>ΠΡΟΣΟΧΗ!</b>
	<p><b>Κίνδυνων από πτώση εξαρτημάτων εξαιτίας χαλαρών βιδών!</b> Ζημιά σε άλλα μέρη της συσκευής ή στην οικία του πελάτη, π.χ. δάπεδο.</p> <ul style="list-style-type: none"> <li>▶ Ασφαλίστε τα εξαρτήματα από πτώση.</li> </ul>

Προϋπόθεση:

- ✔ Η συσκευή είναι αποσυνδεδεμένη από την παροχή τροφοδοσίας.
- ✔ Η πόρτα ντουλαπιού έχει αφαιρεθεί. Βλέπε οδηγίες εγκατάστασης.
- ✔ Η πόρτα είναι ανοιχτή.

### 4.2.1 Αφαίρεση επίπεδου μεντεσέ

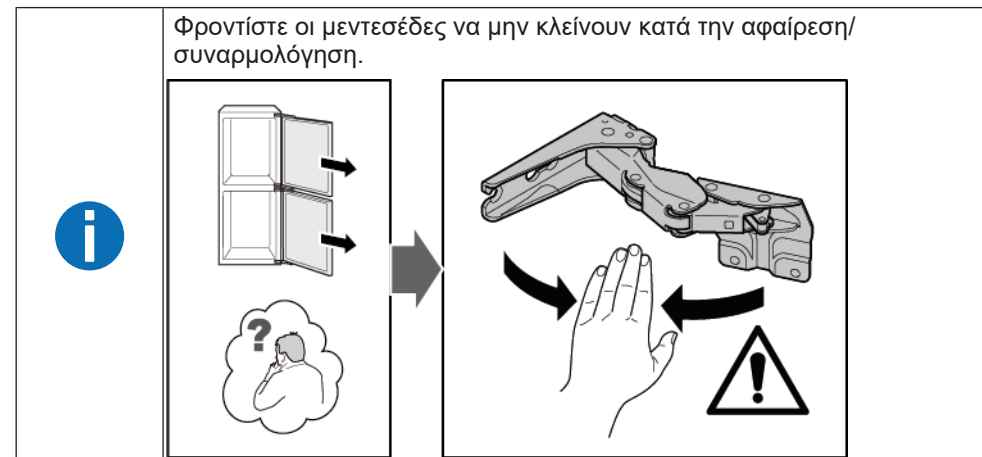

1. Αφαιρέστε τέσσερα καλύμματα μεντεσέ.

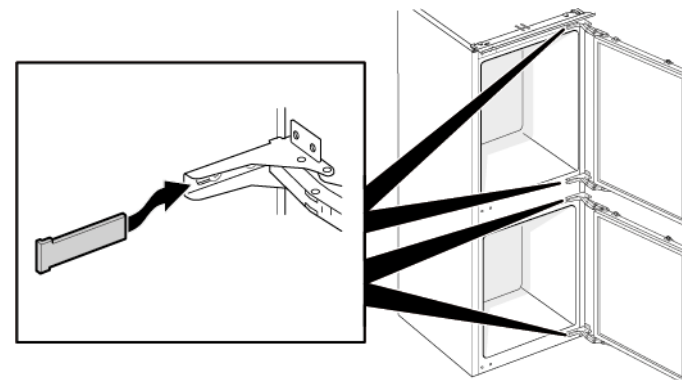

## ΕΠΙΣΚΕΥΗ

2. 1. Χαλαρώστε τέσσερις βίδες (1).  
2. Σύρετε προς τα έξω και αφαιρέστε την επάνω πόρτα (2).

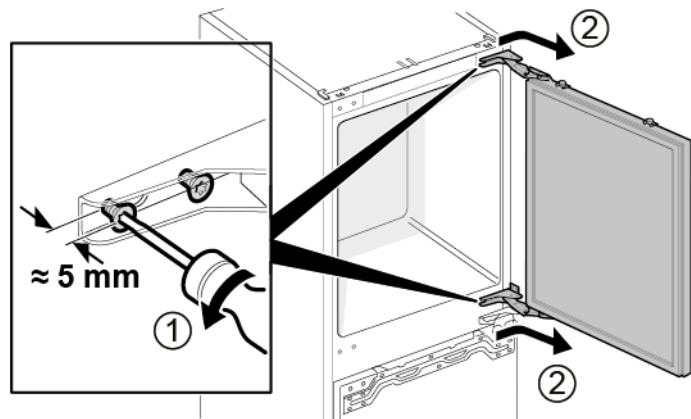

3. 1. Αφαιρέστε τέσσερις βίδες (1).  
2. Αφαιρέστε τους μεντεσέδες (2).

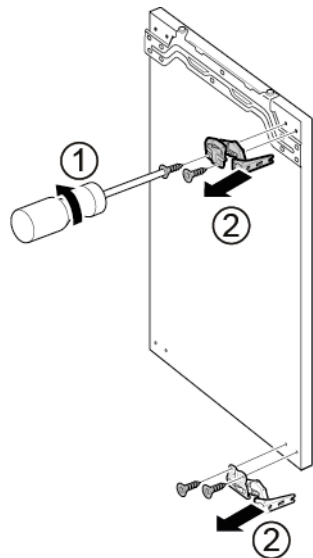

 Οι επάνω μεντεσέδες πόρτας έχουν αφαιρεθεί.

4. 1. Χαλαρώστε τέσσερις βίδες (1).  
2. Σύρετε προς τα έξω και αφαιρέστε την κάτω πόρτα (2).

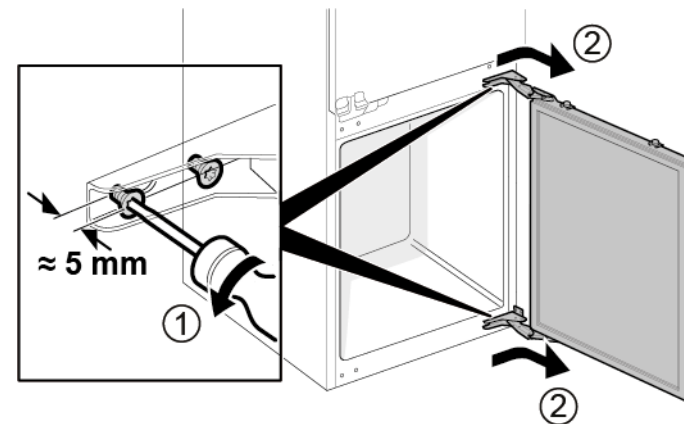

5. 1. Αφαιρέστε τέσσερις βίδες (1).  
2. Αφαιρέστε τους μεντεσέδες (2).

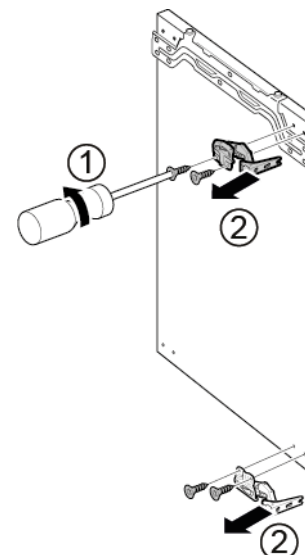

 Οι κάτω μεντεσέδες πόρτας έχουν αφαιρεθεί.

#### **4.2.2 Τοποθέτηση επίπεδου μεντεσέ**

- ▶ Εγκαταστήστε με την αντίθετη σειρά.

### 4.3 Αντικατάσταση συρόμενου μεντεσέ

Ειδικά βοηθητικά μέσα:

 Μύτη Torx TX20      6,3 mm (1/4")      [00340865]



	<b>⚠ ΠΡΟΕΙΔΟΠΟΙΗΣΗ</b>
	<p><b>Βαριές, ογκώδεις συσκευές!</b> Τραυματισμοί μέσης και μυών</p> <ul style="list-style-type: none"> <li>▶ Η διαδικασία αφαίρεσης της πόρτας της συσκευής πρέπει να εκτελείται μόνο από εκπαιδευμένους ειδικούς.</li> <li>▶ Η μετακίνηση της συσκευής πρέπει να εκτελείται από δύο άτομα.</li> <li>▶ Χρησιμοποιείτε μόνο κατάλληλα εργαλεία και εξοπλισμό.</li> </ul>

	<b>⚠ ΠΡΟΣΟΧΗ</b>
	<p><b>Αιχμηρές ακμές!</b> Τραυματισμοί από κοπή</p> <ul style="list-style-type: none"> <li>▶ Φοράτε προστατευτικά γάντια.</li> </ul>

	<b>⚠ ΠΡΟΣΟΧΗ</b>
	<p><b>Κίνδυνοι από πτώση μερών εξαιτίας χαλαρών βιδών!</b> Τραυματισμός εξαιτίας πτώσης τμημάτων.</p> <ul style="list-style-type: none"> <li>▶ Ασφαλίστε τα εξαρτήματα από πτώση.</li> </ul>

	<b>ΠΡΟΣΟΧΗ!</b>
	<p><b>Κίνδυνων από πτώση εξαρτημάτων εξαιτίας χαλαρών βιδών!</b> Ζημιά σε άλλα μέρη της συσκευής ή στην οικία του πελάτη, π.χ. δάπεδο.</p> <ul style="list-style-type: none"> <li>▶ Ασφαλίστε τα εξαρτήματα από πτώση.</li> </ul>

**Προϋπόθεση:**

-  Η συσκευή είναι αποσυνδεδεμένη από την παροχή τροφοδοσίας.
-  Η πόρτα ντουλαπιού και η πόρτα συσκευής είναι διαχωρισμένες. Βλέπε οδηγίες εγκατάστασης.

#### 4.3.1 Αφαίρεση συρόμενου μεντεσέ

1. 1. Ξεβιδώστε δύο βίδες (1).
2. Αφαιρέστε τον επάνω μεντεσέ επάνω πόρτας (2).
3. Αφαιρέστε την επάνω πόρτα (3).
4. Ξεβιδώστε δύο βίδες (4).
5. Αφαιρέστε τον επάνω μεντεσέ κάτω πόρτας (5).
6. Αφαιρέστε την κάτω πόρτα (6).

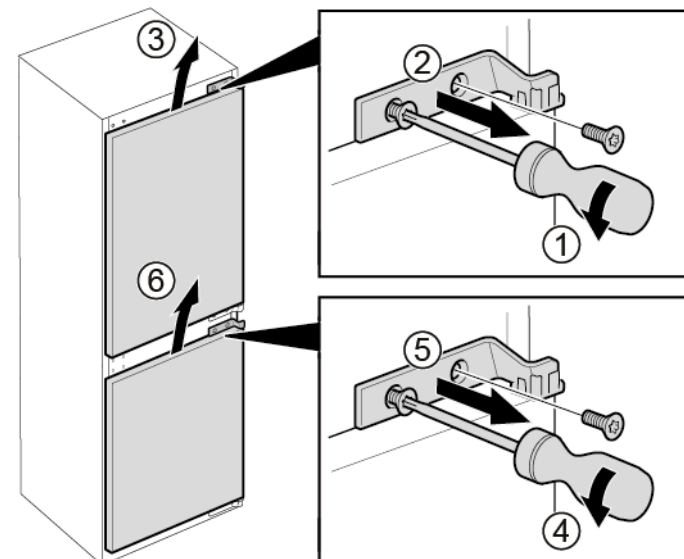

1. Αφαιρέστε τέσσερις βίδες (1).
2. Αφαιρέστε τους κάτω μεντεσέδες (2).

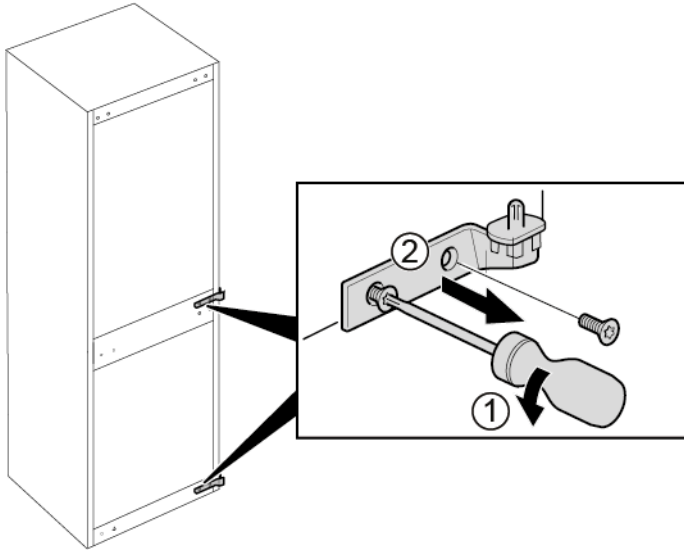

➡ Οι μεντεσέδες έχουν αφαιρεθεί.

### 4.3.2 Τοποθέτηση συρόμενου μεντεσέ

- ▶ Εγκαταστήστε με την αντίθετη σειρά.

## 4.4 Αντικατάσταση ραφιού πόρτας

Προϋπόθεση:

- ✔ Η πόρτα είναι ανοιχτή.

### 4.4.1 Αφαίρεση ραφιού πόρτας

- ▶ Ανασηκώστε το ράφι πόρτας προς τα επάνω.

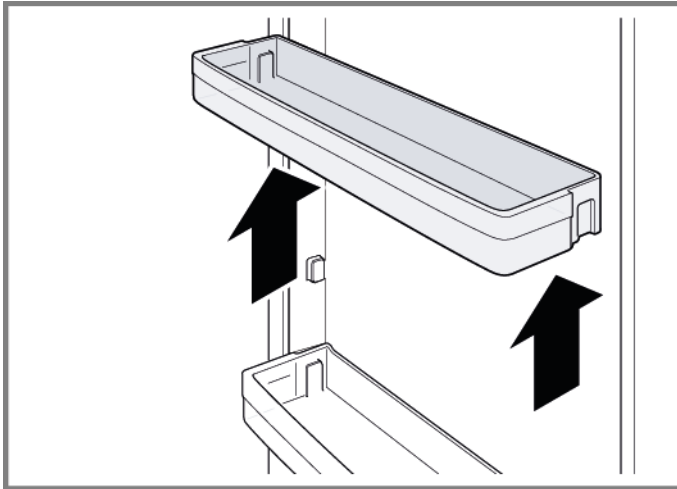

- ➡ Το ράφι πόρτας έχει αφαιρεθεί.

### 4.4.2 Τοποθέτηση ραφιού πόρτας

- ▶ Εγκαταστήστε με την αντίθετη σειρά.

## 4.5 Αντικατάσταση ραφιού

Προϋπόθεση:

- ✔ Η πόρτα είναι ανοιχτή.

### 4.5.1 Αφαίρεση ραφιού

- ▶ Τραβήξτε το ράφι προς τα έξω.

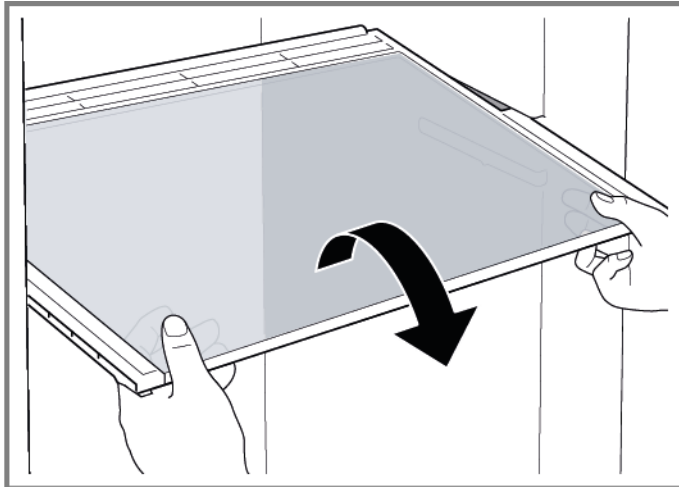

- ➡ Το ράφι αφαιρέθηκε.

### 4.5.2 Τοποθέτηση ραφιού

- ▶ Εγκαταστήστε με την αντίθετη σειρά.



## 4.6 Αντικατάσταση τηλεσκοπικού ραφιού

Προϋπόθεση:

- ✔ Η πόρτα είναι ανοιχτή.

### 4.6.1 Αφαίρεση τηλεσκοπικού ραφιού

1. Τραβήξτε προς τα έξω το τηλεσκοπικό ράφι μέχρι να απελευθερωθεί το άγκιστρο ασφάλισης.

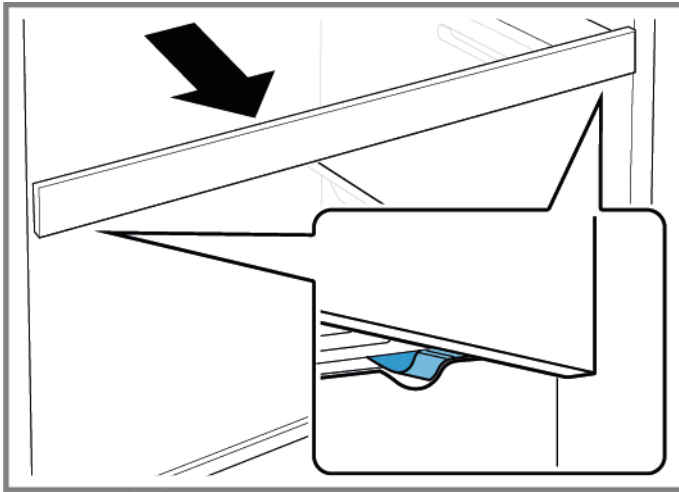

2. Κατεβάστε το τηλεσκοπικό ράφι και στρέψτε το έξω πλευρικά.
3. ➡ Το τηλεσκοπικό ράφι αφαιρέθηκε.

### 4.6.2 Τοποθέτηση τηλεσκοπικού ραφιού

- ▶ Εγκαταστήστε με την αντίθετη σειρά.

## 4.7 Αντικατάσταση ραφιού χώρου κατάψυξης

Προϋπόθεση:

- ✔ Η πόρτα είναι ανοιχτή.

### 4.7.1 Αφαίρεση ραφιού χώρου κατάψυξης

- ▶ Τραβήξτε προς τα έξω το ράφι χώρου κατάψυξης.

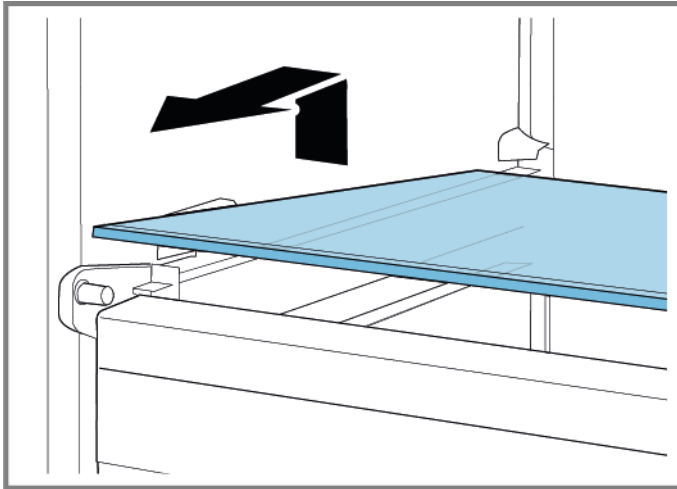

- ➡ Το ράφι χώρου κατάψυξης έχει αφαιρεθεί.

### 4.7.2 Τοποθέτηση ραφιού χώρου κατάψυξης

- ▶ Εγκαταστήστε με την αντίθετη σειρά.

## 4.8 Αντικατάσταση συρταριού κατεψυγμένων τροφίμων

Προϋπόθεση:

- ✔ Η πόρτα είναι ανοιχτή.

### 4.8.1 Αφαίρεση συρταριού κατεψυγμένων τροφίμων

- ▶ 1. Τραβήξτε προς τα έξω ολόκληρο το συρτάρι κατεψυγμένων τροφίμων (1).
- ▶ 2. Αφαιρέστε το συρτάρι κατεψυγμένων τροφίμων (2).

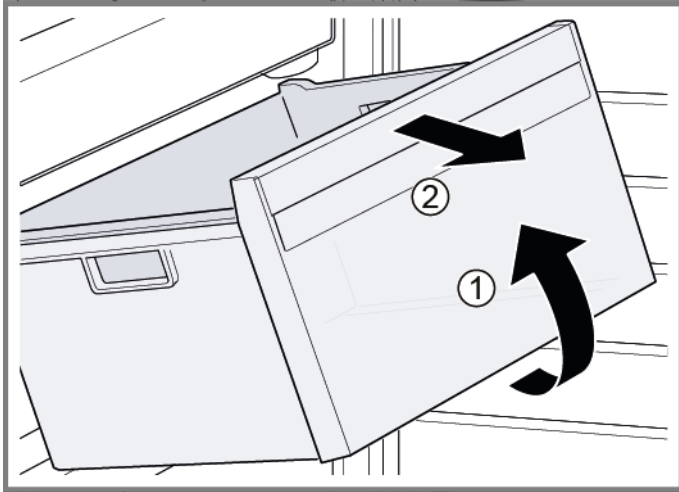

- ➡ Το συρτάρι κατεψυγμένων τροφίμων έχει αφαιρεθεί.

### 4.8.2 Τοποθέτηση συρταριού κατεψυγμένων τροφίμων

- ▶ Εγκαταστήστε με την αντίθετη σειρά.

## 4.9 Αντικατάσταση συρταριού φρούτων και λαχανικών

Προϋπόθεση:

- ✔ Η πόρτα είναι ανοιχτή.

### 4.9.1 Αφαίρεση συρταριού φρούτων και λαχανικών

- ▶ 1. Τραβήξτε προς τα έξω ολόκληρο το συρτάρι (1).
- ▶ 2. Αφαιρέστε το συρτάρι (2).

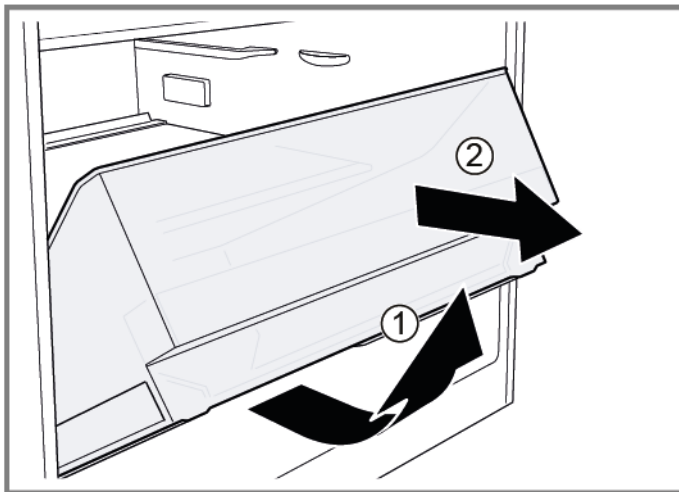

- ➡ Το συρτάρι αφαιρέθηκε.

### 4.9.2 Τοποθέτηση συρταριού φρούτων και λαχανικών

- ▶ Εγκαταστήστε με την αντίθετη σειρά.

## 4.10 Αντικατάσταση διαχωριστικού και καλύμματος συρταριού φρούτων και λαχανικών

Προϋπόθεση:

- ✔ Η πόρτα είναι ανοιχτή.

### 4.10.1 Αφαίρεση διαχωριστικού και καλύμματος συρταριού φρούτων και λαχανικών

1. Αφαιρέστε τη γυάλινη πλάκα από το διαχωριστικό.

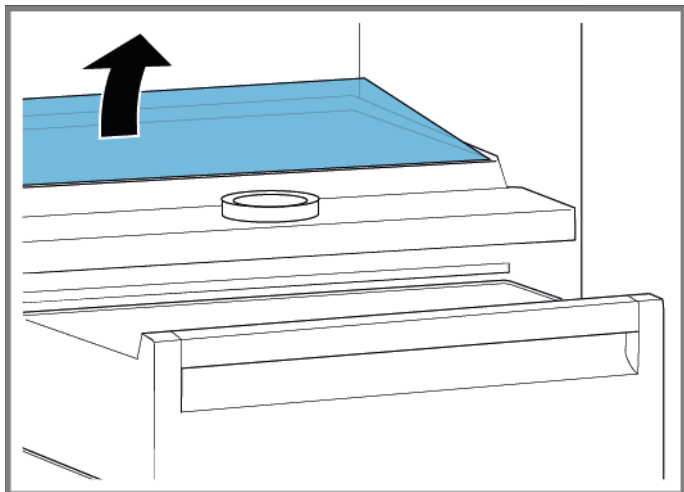

2. [Αφαιρέστε το συρτάρι φρούτων και λαχανικών. → 260](#)

3. 1. Πιέστε τον μοχλό στο κάτω μέρος και των δύο μερών διαχωριστικού (1).
2. Τραβήξτε το διαχωριστικό προς τα εμπρός (2).

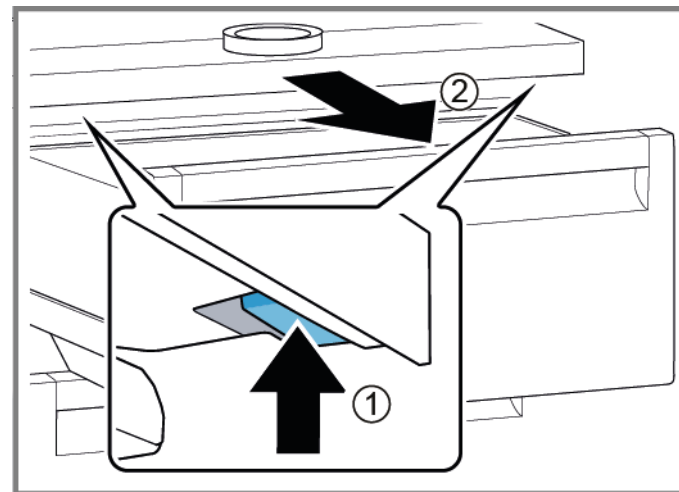

4. Ανασηκώστε το διαχωριστικό και περιστρέψτε το στην άκρη.  
➡ Το διαχωριστικό αφαιρέθηκε.
5. 1. Ανασηκώστε το κάλυμμα συρταριού φρούτων και λαχανικών.  
2. Σπρώξτε το κάλυμμα συρταριού φρούτων και λαχανικών προς τα εμπρός και περιστρέψτε το στην άκρη για να το αφαιρέσετε.  
➡ Το κάλυμμα συρταριού φρούτων και λαχανικών έχει αφαιρεθεί.

### 4.10.2 Τοποθέτηση διαχωριστικού και καλύμματος συρταριού φρούτων και λαχανικών

- ▶ Εγκαταστήστε με την αντίθετη σειρά.

## 4.11 Αντικατάσταση συρταριού cool-fresh

Προϋπόθεση:

- ✔ Η πόρτα είναι ανοιχτή.

### 4.11.1 Αφαίρεση συρταριού cool-fresh

- ▶ 1. Γείρετε το συρτάρι cool-fresh προς τα εμπρός (1).
- ▶ 2. Αφαιρέστε το συρτάρι cool-fresh (2).

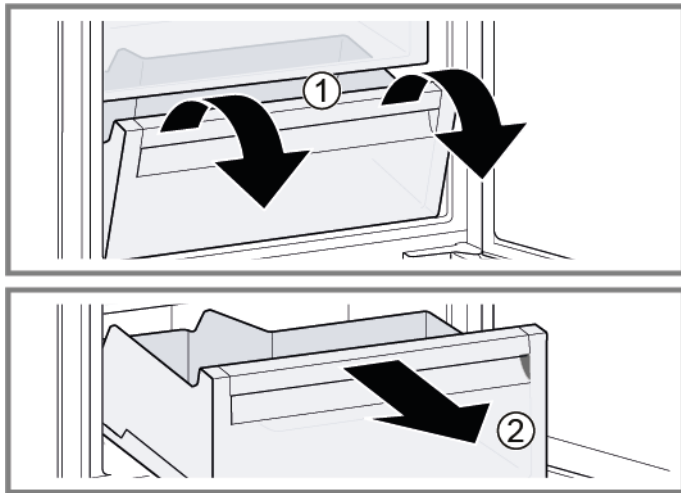

➡ Το συρτάρι cool-fresh αφαιρέθηκε.

### 4.11.2 Τοποθέτηση συρταριού cool-fresh

- ▶ Εγκαταστήστε με την αντίθετη σειρά.

## 4.12 Αντικατάσταση τηλεσκοπικού συρταριού

Προϋπόθεση:

- ✔ Η πόρτα είναι ανοιχτή.

### 4.12.1 Αφαίρεση τηλεσκοπικού συρταριού

- ▶ 1. Γείρετε το τηλεσκοπικό συρτάρι προς τα εμπρός (1).
- ▶ 2. Αφαιρέστε το τηλεσκοπικό συρτάρι (2).

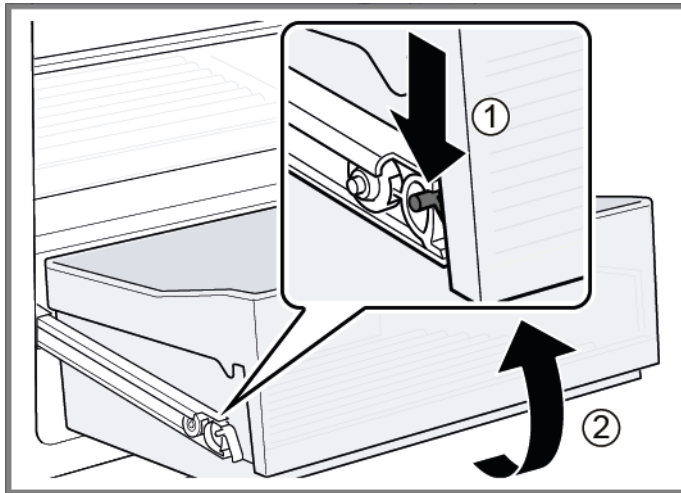



➡ Το τηλεσκοπικό συρτάρι αφαιρέθηκε.

### 4.12.2 Τοποθέτηση τηλεσκοπικού συρταριού

- ▶ Εγκαταστήστε με την αντίθετη σειρά.

### 4.13 Αντικατάσταση προβολέα LED

Ειδικά βοηθητικά μέσα:

-  Ειδικό εργαλείο [00342180]
-  Πλακέ κατσαβίδι Λεπίδα 2,4 mm x 0,4 mm x 60 mm, στο κιτ [00341820]

 Η συσκευή διαθέτει ένα φως LED που δεν χρειάζεται συντήρηση. Αυτά τα φώτα μπορούν να επισκευαστούν μόνο από την εξυπηρέτηση πελατών ή από εξουσιοδοτημένους τεχνικούς!

 **ΚΙΝΔΥΝΟΣ**  
**Κίνδυνος ηλεκτροπληξίας λόγω ηλεκτροφόρων μερών!**  
 Κίνδυνος για τη ζωή από ηλεκτροπληξία σε περίπτωση ακατάλληλης επισκευής

- ▶ Τα ηλεκτρικά μέρη πρέπει να επισκευάζονται από εκπαιδευμένους ηλεκτρολόγους.
- ▶ Μετά την επισκευή πραγματοποιήστε έλεγχο ασφάλειας σύμφωνα με το VDE 0701 ή κανονισμούς της συγκεκριμένης χώρας.



 **ΚΙΝΔΥΝΟΣ**  
**Κίνδυνος ηλεκτροπληξίας λόγω ηλεκτροφόρων μερών!**  
 Θάνατος από ηλεκτροπληξία

- ▶ Αποσυνδέετε τις συσκευές από την παροχή ηλεκτρικού ρεύματος τουλάχιστον 60 δευτερόλεπτα πριν ξεκινήσετε τις επισκευές.

 **ΠΡΟΣΟΧΗ**  
**Αιχμηρές ακμές!**  
 Τραυματισμοί από κοπή

- ▶ Φοράτε προστατευτικά γάντια.

**Προϋπόθεση:**

-  Η συσκευή είναι αποσυνδεδεμένη από την παροχή τροφοδοσίας.
-  Η πόρτα είναι ανοιχτή.
-  Τα ράφια χώρου συντήρησης έχουν αφαιρεθεί.

#### 4.13.1 Αφαίρεση spot φωτισμού LED

1. Απελευθερώστε το κάλυμμα spot φωτισμού LED.

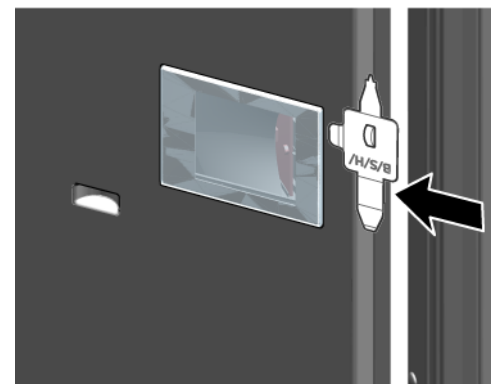

2. Τραβήξτε το κάλυμμα spot φωτισμού LED προς τα μέσα και ταυτόχρονα σπρώξτε προς τα εμπρός.

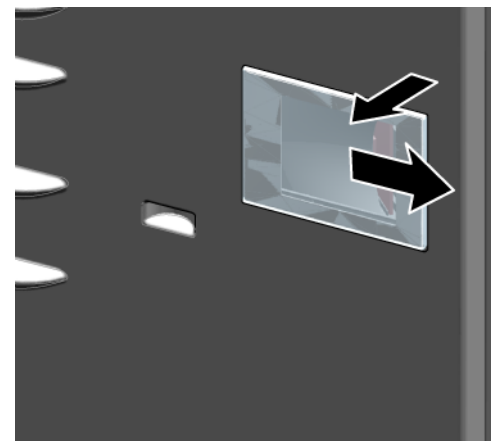



3. Απασφαλίστε τη μονάδα spot φωτισμού LED.

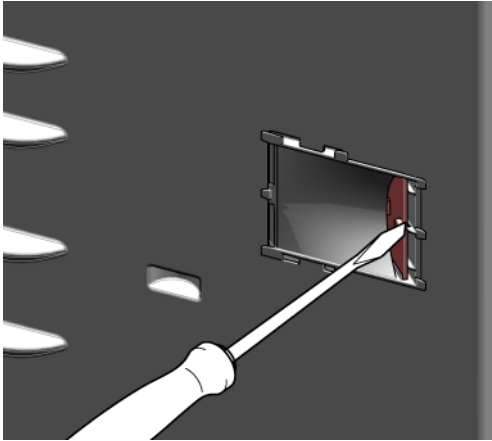

4. Αποσυνδέστε την ηλεκτρική σύνδεση spot φωτισμού LED.

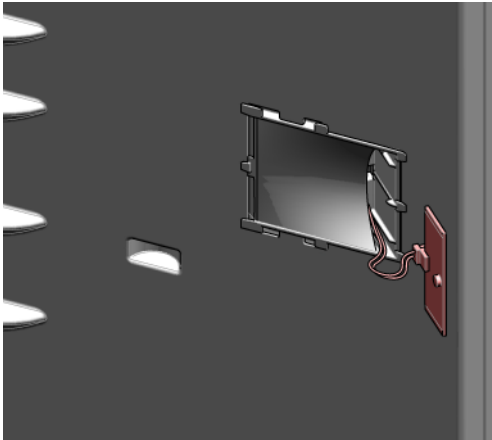

- ➔ Το spot φωτισμού LED αφαιρέθηκε.

### 4.13.2 Τοποθέτηση spot φωτισμού LED

- ▶ Εγκαταστήστε με την αντίθετη σειρά.

# Javítási útmutató - Hűtő-/fagyasztó-kombináció

## **A dokumentummal kapcsolatos információk..... 267**

1.1	Fontos tudnivalók .....	267
1.1.1	Cél .....	267
1.2	Szimbólummagyarázat .....	267
1.2.1	Veszélyességi szintek .....	267
1.2.2	Veszélyt jelző szimbólumok .....	267
1.2.3	A figyelmeztetések felépítése .....	268
1.2.4	Általános szimbólumok.....	268

## **Biztonság ..... 269**

2.1	Általános biztonsági utasítások.....	269
2.1.1	Összes háztartási készülék .....	269

## **Szerszámok és segédanyagok..... 270**

## **Javítás ..... 271**

4.1	A gumitömítés cseréje .....	271
4.1.1	A gumitömítés eltávolítása.....	271
4.1.2	A gumitömítés beszerelése.....	271
4.2	Lapos zsanér cseréje.....	274
4.2.1	Lapos zsanér eltávolítása .....	274
4.2.2	Lapos zsanér beszerelése .....	276
4.3	A csúszózszer cseréje .....	277
4.3.1	A csúszózszer eltávolítása .....	277
4.3.2	A csúszózszer felszerelése.....	278
4.4	Az ajtópolc cseréje .....	279
4.4.1	Az ajtópolc eltávolítása.....	279
4.4.2	Az ajtópolc felhelyezése .....	279
4.5	A polc cseréje .....	280
4.5.1	A polc eltávolítása .....	280
4.5.2	A polc beszerelése.....	280
4.6	A kihúzható polc cseréje .....	281
4.6.1	A kihúzható polc eltávolítása.....	281
4.6.2	A kihúzható polc behelyezése.....	281
4.7	Fagyasztórekesz polcának cseréje .....	282
4.7.1	Fagyasztórekesz polcának eltávolítása .....	282
4.7.2	Fagyasztórekesz polcának beszerelése .....	282

4.8	Fagyasztódoboz cseréje.....	283
4.8.1	Fagyasztódoboz eltávolítása .....	283
4.8.2	A fagyasztódoboz behelyezése .....	283
4.9	A gyümölcs- és zöldségtároló cseréje .....	284
4.9.1	A gyümölcs- és zöldségtároló eltávolítása.....	284
4.9.2	A gyümölcs- és zöldségtároló behelyezése .....	284
4.10	A gyümölcs- és zöldségtároló elválasztóelemének cseréje .....	285
4.10.1	A gyümölcs- és zöldségtároló elválasztóelemének eltávolítása .....	285
4.10.2	A gyümölcs- és zöldségtároló elválasztóelemének és fedelének behelyezése .....	285
4.11	A frissentartó rekesz cseréje.....	286
4.11.1	A frissentartó rekesz eltávolítása .....	286
4.11.2	A frissentartó rekesz behelyezése .....	286
4.12	A kihúzható tároló cseréje .....	287
4.12.1	A kihúzható tároló eltávolítása .....	287
4.12.2	A kihúzható tároló behelyezése .....	287
4.13	LED-es oldalsó spotvilágítás cseréje .....	288
4.13.1	LED-es spotvilágítás eltávolítása .....	288
4.13.2	A LED-es spotvilágítás beszerelése.....	289

# **i** A dokumentummal kapcsolatos információk

## 1.1 Fontos tudnivalók

### 1.1.1 Cél

Ezek a javítási tanácsok támogatják a fogyasztót a készülékek otthoni megjavításában a környezettudatos tervezésről szóló rendeletnek (2021 márciusától alkalmazandó) megfelelően.

Információkat tartalmaznak bizonyos pótalkatrészek cseréjével kapcsolatban, ideértve a figyelmeztetéseket és a kockázatokat is.

Ha kérdése van, vegye fel a kapcsolatot a vevőszolgálattal. A károkért kizárólag akkor vállalunk felelősséget, ha a javítási tanácsokat pontosan betartották.

## 1.2 Szimbólummagyarázat

### 1.2.1 Veszélyességi szintek

A veszélyességi szintek egy szimbólumból és egy figyelmeztető mondatból állnak. A figyelmeztető mondat utal a veszély súlyosságára.





Veszélyességi szint	Jelentés
 <b>VESZÉLY</b>	A figyelmeztető üzenet figyelmen kívül hagyása halált vagy súlyos sérüléseket okoz.
 <b>FIGYELMEZTETÉS</b>	A figyelmeztető üzenet figyelmen kívül hagyása halált vagy súlyos sérüléseket okozhat.
 <b>VIGYÁZAT</b>	A figyelmeztető üzenet figyelmen kívül hagyása kisebb sérüléseket okozhat.
<b>FIGYELEM!</b>	A figyelmeztető üzenet figyelmen kívül hagyása anyagi károkat okozhat.

Táblázat 1: Veszélyességi szintek

### 1.2.2 Veszélyt jelző szimbólumok

A veszélyt jelző szimbólumok a veszélyt ábrázoló szimbolikus ábrázolások.

A jelen dokumentumban az alábbi veszélyt jelző szimbólumok használatosak:

Veszélyt jelző szimbólum	Jelentés
	Általános figyelmeztető üzenet
	Elektromos feszültség veszélye
	Robbanásveszély
	Vágásveszély
	Zúzódásveszély

## **i** A dokumentummal kapcsolatos információk

Veszélyt jelző szimbólum	Jelentés
	Forró felületek miatt fennálló veszély
	Erős mágneses mező miatt fennálló veszély
	Nem ionizáló sugárzás veszélye

Táblázat 2: Veszélyt jelző szimbólumok

### 1.2.3 A figyelmeztetések felépítése

A jelen dokumentumban lévő figyelmeztetések szabványosított megjelenésűek és felépítésűek.

	<p><b>⚠ VESZÉLY</b></p> <p><b>A veszély típusa és forrása!</b> A veszély / figyelmeztetés figyelmen kívül hagyásának lehetséges következményei.</p> <ul style="list-style-type: none"> <li>▶ A veszély megelőzésére szolgáló intézkedések és tiltások.</li> </ul>
--	---

Az alábbi példa egy olyan figyelmeztetést mutat be, amely az áram alatt lévő alkatrészek okozta áramütésre figyelmeztet. Megemlíti a veszély elkerülésére szolgáló intézkedést.

	<p><b>⚠ VESZÉLY</b></p> <p><b>Áramütés veszélye áram alatt lévő alkatrészek miatt!</b> Halálos áramütés</p> <ul style="list-style-type: none"> <li>▶ A javítás megkezdése előtt legalább 60 másodperccel válassza le a készülékeket az elektromos hálózatról.</li> </ul>
--	--

### 1.2.4 Általános szimbólumok

A jelen dokumentumban az alábbi általános szimbólumok használatosak:

Ált. szimbólum	Jelentés
	Különleges tanács (szöveg és/vagy grafika)

Ált. szimbólum	Jelentés
	Egyszerű tanács (csak szöveg)
	Videós oktatóanyagra mutató hivatkozás
	A szükséges eszközök
	A szükséges feltételek
	Feltétel (ha..., akkor...)
	Eredmény
[Indítás]	Billentyű vagy gomb
[00123456]	Anyagszám azonosítója
Állapot	Megjelenített szöveg / ablak (a készülék kijelzőjén)

Táblázat 3: Általános szimbólumok

## 2.1 Általános biztonsági utasítások

### 2.1.1 Összes háztartási készülék

#### **Áramütés veszélye áram alatt lévő alkatrészek miatt!**

- Az elektromos alkatrészek hibás javítása áramütéshez vezethet!
- A javítás megkezdése előtt legalább 60 másodperccel válassza le a készüléket az elektromos hálózatról.
- A javítás után végeztesse a VDE 0701-nek vagy az országspecifikus szabályozásoknak megfelelő vizsgálatot.

#### **Éles peremek miatt fennálló sérülésveszély!**

- Viseljen védőkesztyűt.

#### **Zúzódásveszély a javítás, karbantartás, hibaelhárítás és szervizelés során a nehéz és mozgó alkatrészek miatt**

- Viseljen védőcipőt.
- Biztosítsa leesés ellen a nehéz alkatrészeket.
- Ne dugja be a testrészeit a mozgó alkatrészek közé.



#### **Sérülhet a készülék biztonsága / működése!**

- Kizárólag eredeti pótalkatrészeket használjon.

#### **Elektrosztatikailag érzékeny alkatrészek (ESD-k) károsodásának veszélye!**

- Ne érintse meg a modulokat, ideértve a csatlakozásokat és a vezetőket.

## Szerszámok és segédanyagok

Kijelölés	Részletek	Képek
Védőrongy [00342013]	60 cm x 50 cm	
TX20 Torx bithegy [00340865]	6,3 mm (1/4")	
Különleges szer- szám [00342180]		

## 4.1 A gumitömítés cseréje

### Követelmény:

- ✓ Az ajtó nyitva van

### 4.1.1 A gumitömítés eltávolítása

1. Vegye ki a gumitömítést a barázdából a jobb és a bal sarokban.

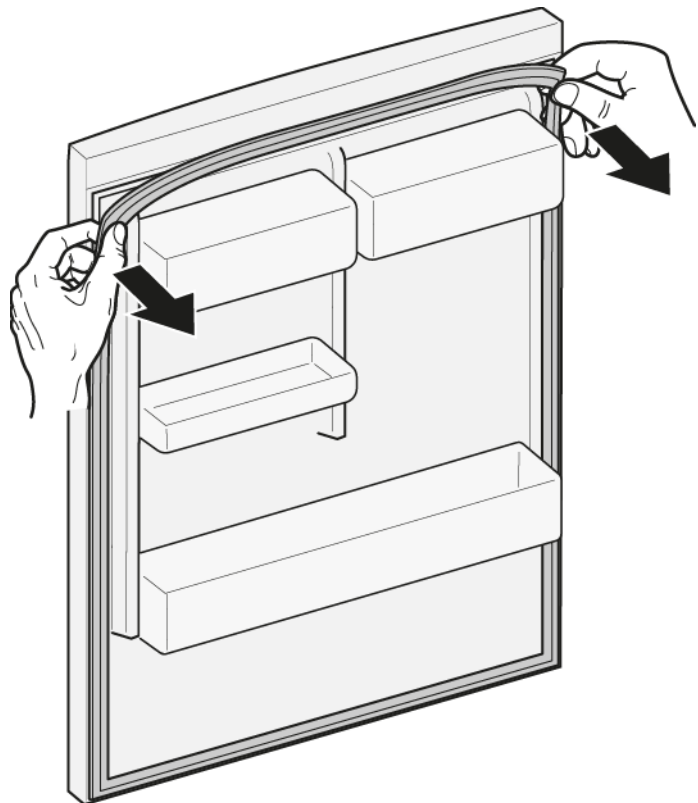

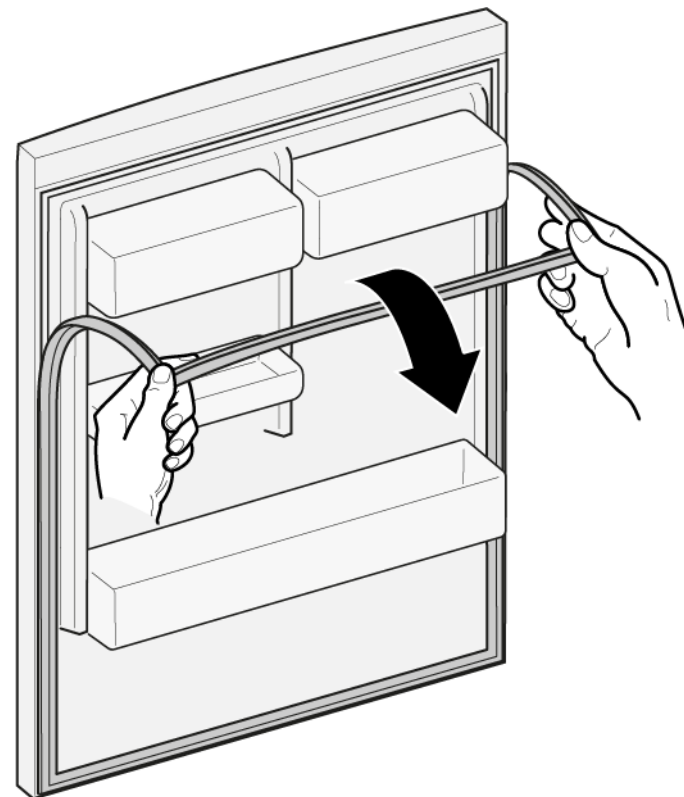

2. Húzza ki a gumitömítést a barázdából.



- ➡ Eltávolította a gumitömítést.

### 4.1.2 A gumitömítés beszerelése

	Az új gumitömítés vastagsága enyhén eltérhet a régi gumitömítés vastagságától. Ez nem befolyásolja az ajtócsukás módját és hosszú távú működését.
	Ha a készülékében beállítható zsanérok vagy zsanérrögzítések vannak, utólag optimalizálhatja a becsukás módját.
	A gumitömítésben lévő apró, oldalsó lyukak funkcionálisak (a szellőzéshez szükségesek). Ezek nem gyártási hibák.

1. Ellenőrizze a barázdát sérülések szempontjából.

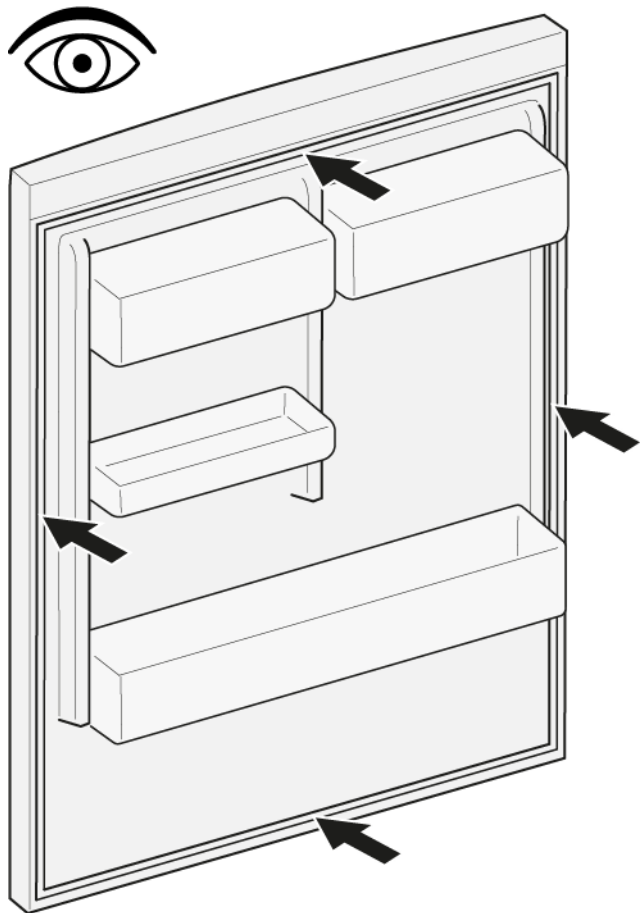

4. Nyomja a gumitömítés fenti és lenti sarkait a barázdába.

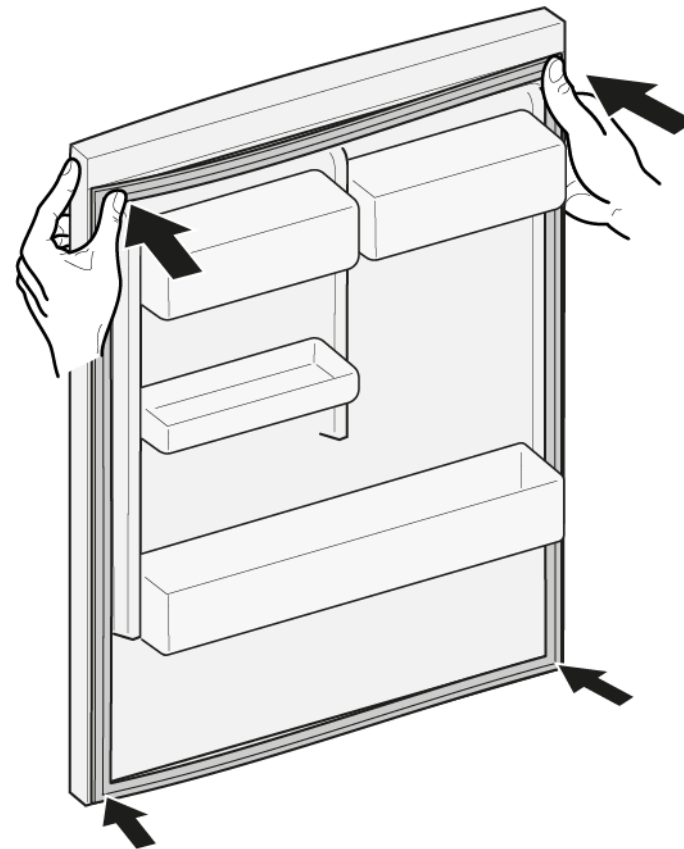

2. ⓘ Ha a gumitömítés barázdája sérült:  
- Vegye fel a kapcsolatot az ügyfélszolgálattal.

3. ⓘ A gumitömítés enyhe deformálódása normális, és nem befolyásolja a működését. Javasolt a gumitömítés kiegyenesítése a készülékbe történő behelyezés előtt.

Hajszárítóval vagy forró vízzel melegítse fel a gumitömítést, és kézzel formázza újra.



5. Nyomja a teljes gumiötmitést apránként a barázdába.

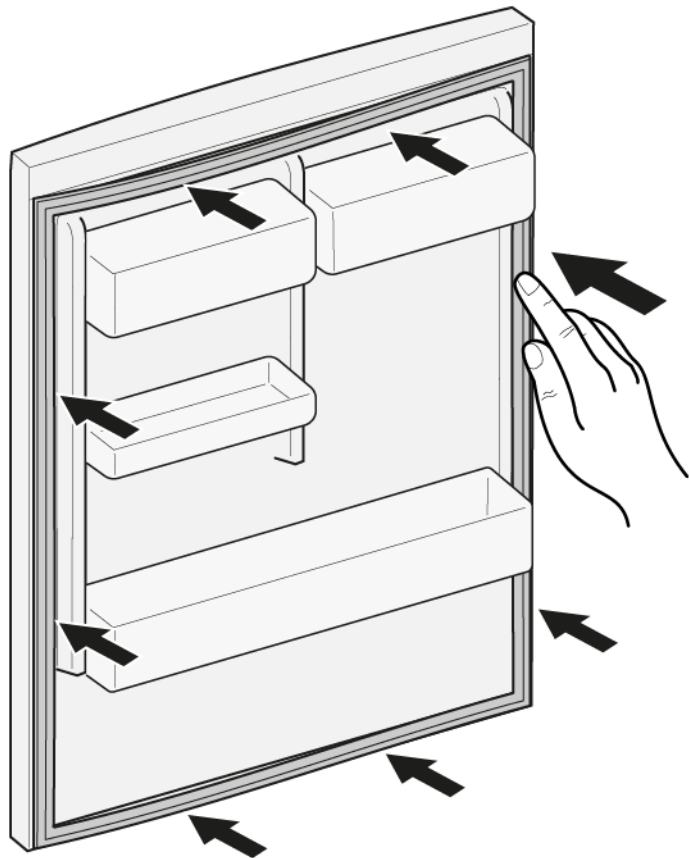

-  Beszerelte a gumiötmitést.

## 4.2 Lapos zsanér cseréje

### Különleges eszközök

 TX20 Torx bithegy

6,3 mm (1/4")

[00340865]

	<b>⚠ FIGYELMEZTETÉS</b>
<p><b>Nehéz, nagy készülékek!</b> Hát- és izomsérülések</p> <ul style="list-style-type: none"> <li>▶ A készülék aajtájának eltávolítását kizárólag szakemberrel végeztesse.</li> <li>▶ A készülék elmozdításához két emberre van szükség.</li> <li>▶ Kizárólag megfelelő eszközöket és berendezéseket használjon.</li> </ul>	



	<b>⚠ VIGYÁZAT</b>
<p><b>Éles szélek!</b> Vágási sérülések</p> <ul style="list-style-type: none"> <li>▶ Viseljen védőkesztyűt.</li> </ul>	

	<b>⚠ VIGYÁZAT</b>
<p><b>Nyitott zsanér!</b> Ujjak zúzódása/beszorulása</p> <ul style="list-style-type: none"> <li>▶ Ne nyúljon be a nyitott zsanérba.</li> <li>▶ Viseljen védőkesztyűt.</li> </ul>	

	<b>⚠ VIGYÁZAT</b>
<p><b>Leeső alkatrészek veszélye a kioldott csavarok miatt!</b> Leeső alkatrészek miatti sérülés.</p> <ul style="list-style-type: none"> <li>▶ Biztosítsa az alkatrészt leesés ellen.</li> </ul>	

	<b>FIGYELEM!</b>
<p><b>Leeső alkatrészek veszélye a kioldott csavarok miatt!</b> A készülék többi részeinek vagy az ügyfél lakásának (pl. padló) károsodása.</p> <ul style="list-style-type: none"> <li>▶ Biztosítsa az alkatrészt leesés ellen.</li> </ul>	

### Követelmény:

-  A készüléket leválasztotta az áramellátásról.
-  Eltávolította a bútorajtót. Lásd a Beszerelési útmutatót.
-  Az ajtó nyitva van

### 4.2.1 Lapos zsanér eltávolítása

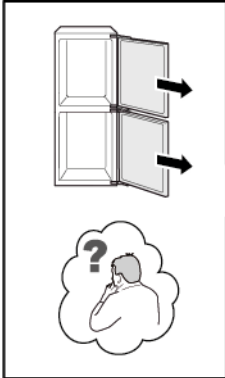
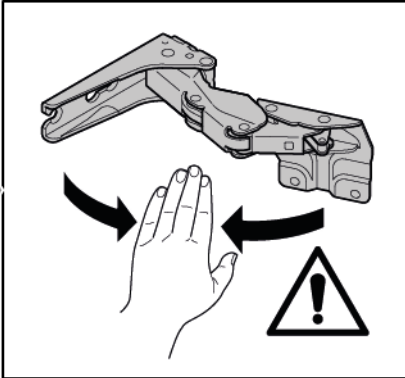
	<p>Figyeljen arra, hogy eltávolítás/beszereelés közben a zsanérok ne csúskódjanak be.</p>	
		

1. Távolítsa el a négy zsanérburkolatot.

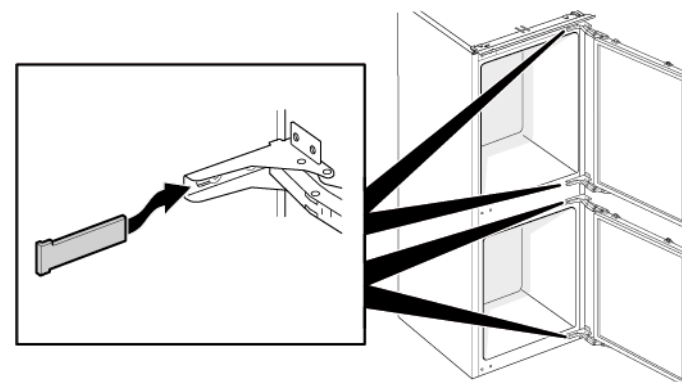

## Javítás

2. 1. Lazítsa meg a négy csavart (1).  
2. Csúsztassa ki és vegye le a felső ajtót (2).

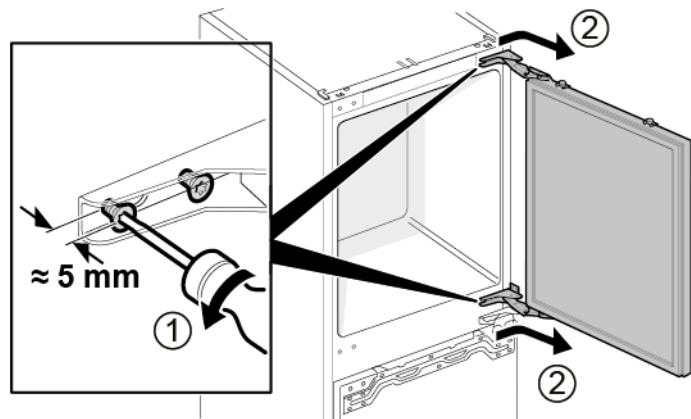

3. 1. Távolítsa el a négy csavart (1).  
2. Távolítsa el a zsanérokat (2).

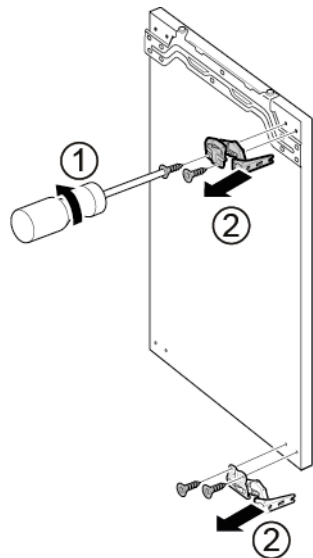

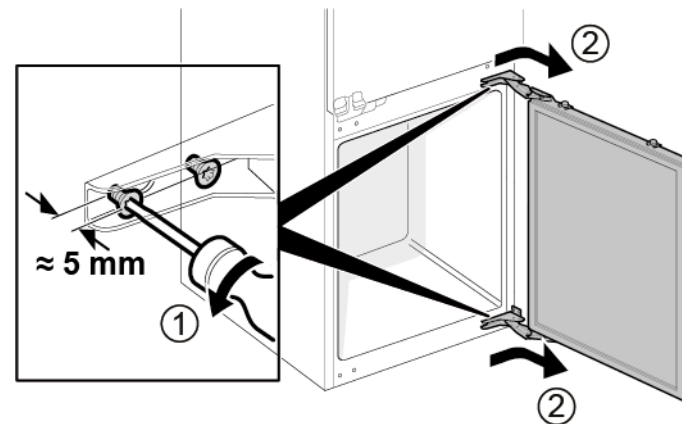

 Eltávolította a felső ajtózsanérokat.

4. 1. Lazítsa meg a négy csavart (1).  
2. Csúsztassa ki és vegye le az alsó ajtót (2).

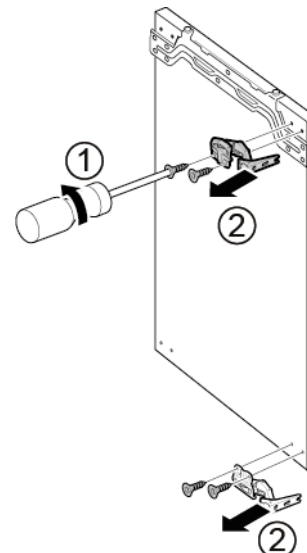

5. 1. Távolítsa el a négy csavart (1).  
2. Távolítsa el a zsanérokat (2).



 Eltávolította az alsó ajtózsanérokat.

#### **4.2.2 Lapos zsanér beszerelése**

- ▶ Az elhelyezést fordított sorrendben végezze.

## 4.3 A csúszózsánér cseréje

### Különleges eszközök

TX20 Torx bithegy

6,3 mm (1/4")

[00340865]



#### FIGYELMEZTETÉS

##### Nehéz, nagy készülékek!

Hát- és izomsérülések

- ▶ A készülék ajtajának eltávolítását kizárólag szakemberrel végeztesse.
- ▶ A készülék elmozdításához két emberre van szükség.
- ▶ Kizárólag megfelelő eszközöket és berendezéseket használjon.



#### VIGYÁZAT

##### Éles szélek!

Vágási sérülések

- ▶ Viseljen védőkesztyűt.



#### VIGYÁZAT

##### Leeső alkatrészek veszélye a kioldott csavarok miatt!

Leeső alkatrészek miatti sérülés.

- ▶ Biztosítsa az alkatrészt leesés ellen.



#### FIGYELEM!

##### Leeső alkatrészek veszélye a kioldott csavarok miatt!

A készülék többi részeinek vagy az ügyfél lakásának (pl. padló) károsodása.

- ▶ Biztosítsa az alkatrészt leesés ellen.

### Követelmény:

- ✔ A készüléket leválasztotta az áramellátásról.
- ✔ Szétválasztotta a bútorajtót és a készülékajtót. Lásd a Beszerelési útmutatót.

### 4.3.1 A csúszózsánér eltávolítása

1. Csavarja ki a két csavart (1).
2. Távolítsa el a felső ajtó felső zsanérját (2).
3. Vegye le a felső ajtót (3).
4. Csavarja ki a két csavart (4).
5. Távolítsa el az alsó ajtó felső zsanérját (5).
6. Vegye le az alsó ajtót (6).

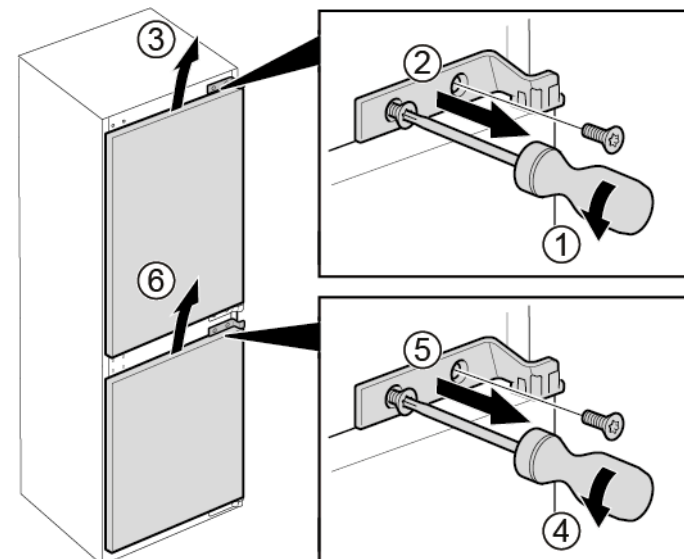

2. 1. Távolítsa el a négy csavart (1).
2. Távolítsa el az alsó zsanérokat (2).

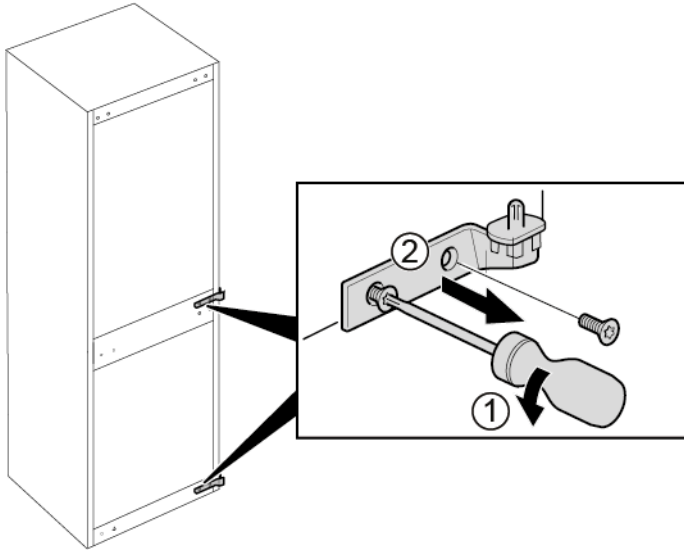

 Eltávolította a zsanérokat.

### 4.3.2 A csúszózsánér felszerelése

- ▶ Az elhelyezést fordított sorrendben végezze.

## 4.4 Az ajtópolc cseréje

### Követelmény:

- ✓ Az ajtó nyitva van

### 4.4.1 Az ajtópolc eltávolítása

- ▶ Emelje fel az ajtópolcot.

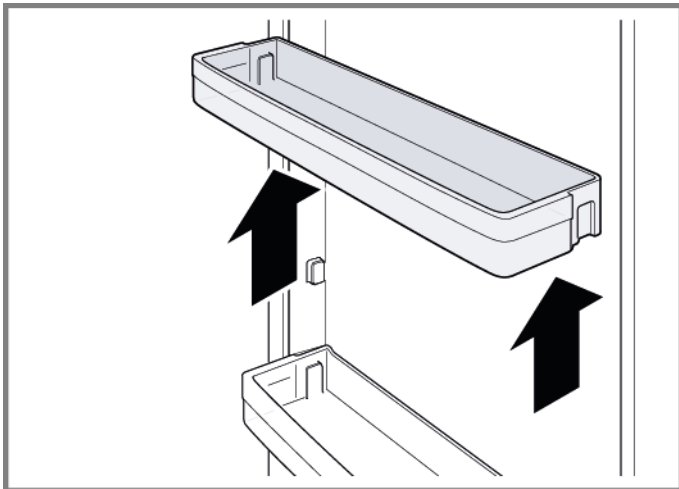

- ➡ Eltávolította az ajtópolcot.

### 4.4.2 Az ajtópolc felhelyezése

- ▶ Az elhelyezést fordított sorrendben végezze.

## 4.5 A polc cseréje

### Követelmény:

- ✔ Az ajtó nyitva van

### 4.5.1 A polc eltávolítása

- ▶ Húzza ki a polcot.

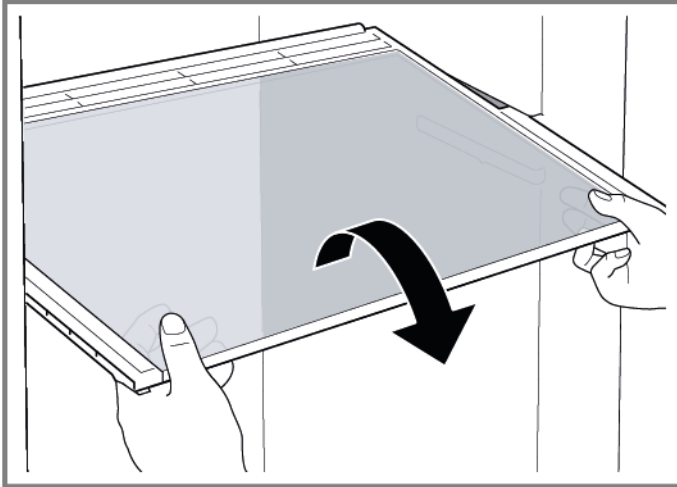

- ➡ Eltávolította a polcot.

### 4.5.2 A polc beszerelése

- ▶ Az elhelyezést fordított sorrendben végezze.



## 4.6 A kihúzható polc cseréje

**Követelmény:**

- ✔ Az ajtó nyitva van

### 4.6.1 A kihúzható polc eltávolítása

1. Húzza ki a kihúzható polcot a rögzítőelem kinyílásáig.

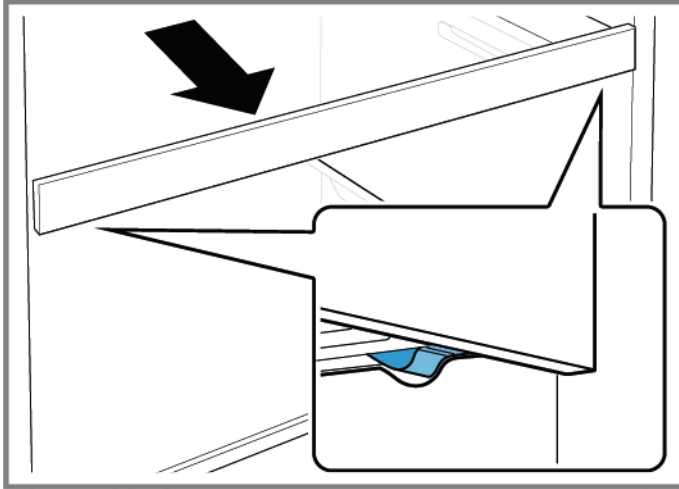

2. Engedje le a kihúzható polcot és emelje ki.
3. ⬅ Eltávolította a kihúzható polcot.

### 4.6.2 A kihúzható polc behelyezése

- ▶ Az elhelyezést fordított sorrendben végezze.

## 4.7 Fagyasztórekesz polcának cseréje

### Követelmény:

- ✔ Az ajtó nyitva van

### 4.7.1 Fagyasztórekesz polcának eltávolítása

- ▶ Húzza ki a fagyasztórekesz polcát.

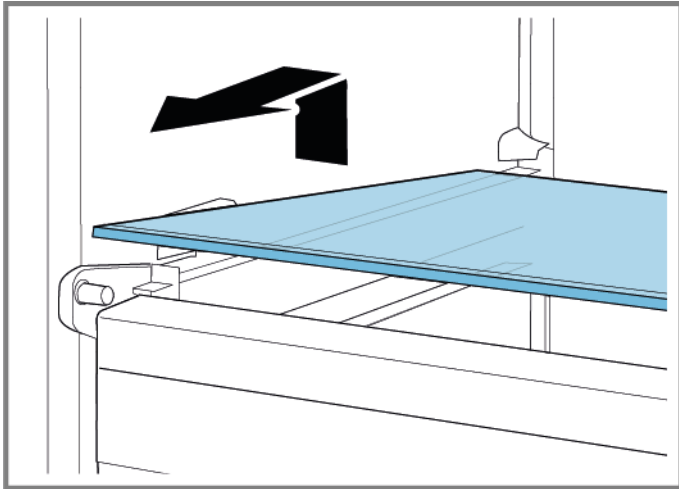

- ➡ Eltávolította a fagyasztórekesz polcát.

### 4.7.2 Fagyasztórekesz polcának beszerelése

- ▶ Az elhelyezést fordított sorrendben végezze.

## 4.8 Fagyasztódoboz cseréje

### Követelmény:

- ✔ Az ajtó nyitva van

### 4.8.1 Fagyasztódoboz eltávolítása

- ▶ 1. Húzza ki teljesen a fagyasztódobozt (1).
- ▶ 2. Távolítsa el a fagyasztódobozt (2).

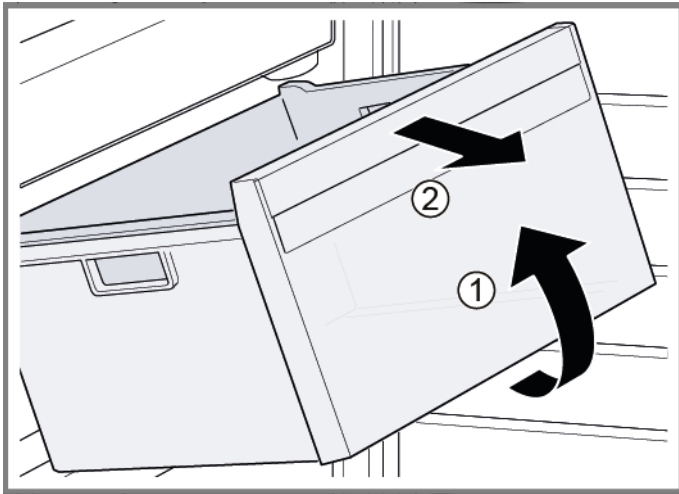

- ➡ Eltávolította a fagyasztódobozt.

### 4.8.2 A fagyasztódoboz behelyezése

- ▶ Az elhelyezést fordított sorrendben végezze.

## 4.9 A gyümölcs- és zöldségtároló cseréje

### Követelmény:

- ✔ Az ajtó nyitva van

### 4.9.1 A gyümölcs- és zöldségtároló eltávolítása

- ▶ 1. Húzza ki teljesen a tárolót (1).
- ▶ 2. Távolítsa el a tárolót (2).

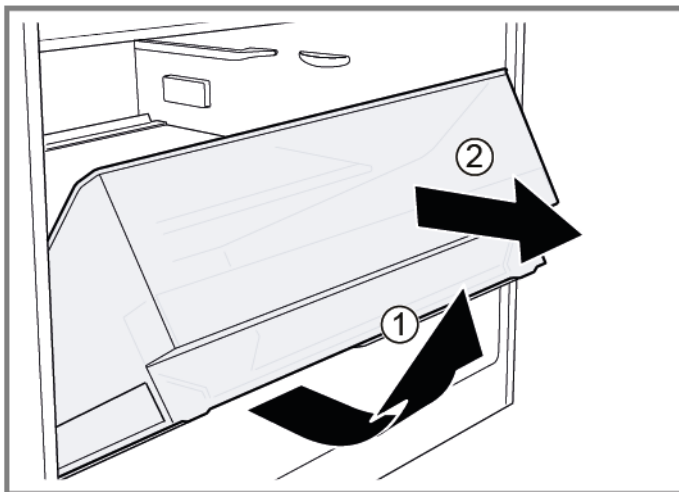

- ➡ Eltávolította a tárolót.

### 4.9.2 A gyümölcs- és zöldségtároló behelyezése

- ▶ Az elhelyezést fordított sorrendben végezze.

## 4.10 A gyümölcs- és zöldségtároló elválasztóelemének cseréje

### Követelmény:

- ✓ Az ajtó nyitva van

### 4.10.1 A gyümölcs- és zöldségtároló elválasztóelemének eltávolítása

1. Távolítsa el az üvegpalcot az elválasztóelemről.

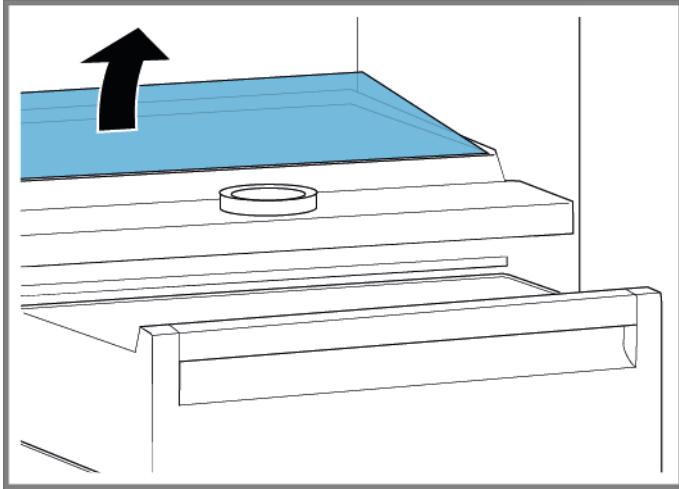

2. [Távolítsa el a gyümölcs- és zöldségtárolót. →284](#)

3. 1. Nyomja meg az elválasztóelem két oldalán található karokat (1).
2. Húzza előre az elválasztóelemet (2).

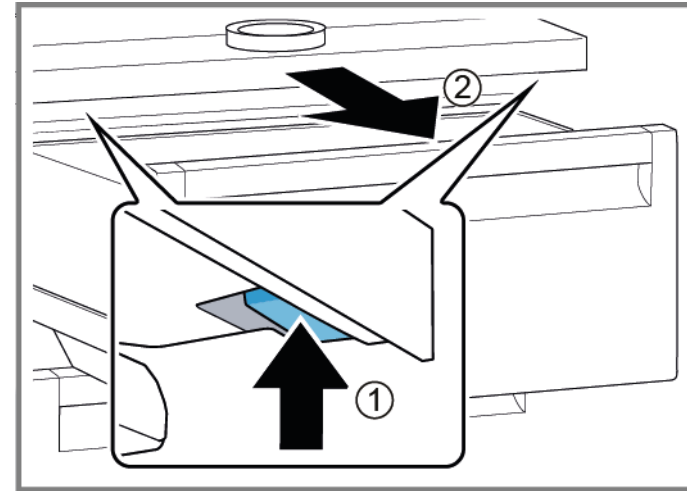

4. Emelje fel az elválasztóelemet, és fordítsa oldalra.  
➡ Eltávolította az elválasztóelemet.
5. 1. Emelje fel a gyümölcs- és zöldségtároló fedelét.  
2. Húzza előre a gyümölcs- és zöldségtároló fedelét, és fordítsa oldalra.  
➡ Eltávolította a gyümölcs- és zöldségtároló fedelét.

### 4.10.2 A gyümölcs- és zöldségtároló elválasztóelemének és fedelének behelyezése

- ▶ Az elhelyezést fordított sorrendben végezze.

## 4.11 A frissentartó rekesz cseréje

### Követelmény:

- ✔ Az ajtó nyitva van

### 4.11.1 A frissentartó rekesz eltávolítása

- ▶ 1. Döntse előre a frissentartó rekeszt (1).
- ▶ 2. Távolítsa el a frissentartó rekeszt (2).

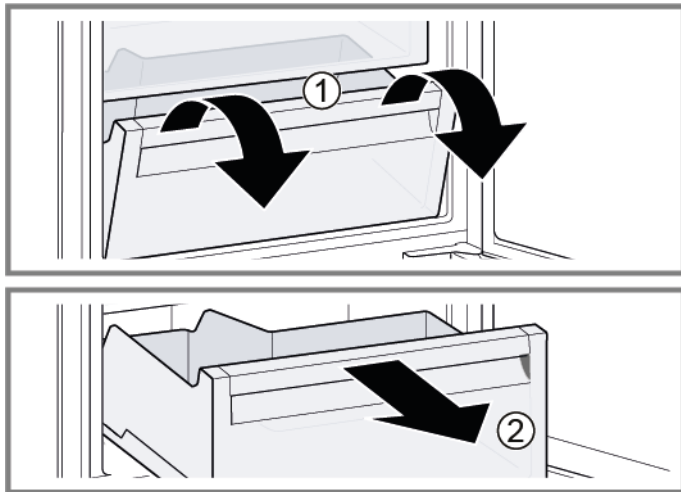

- ➡ Eltávolította a frissentartó rekeszt.

### 4.11.2 A frissentartó rekesz behelyezése

- ▶ Az elhelyezést fordított sorrendben végezze.

## 4.12 A kihúzható tároló cseréje

### Követelmény:

- ✔ Az ajtó nyitva van

### 4.12.1 A kihúzható tároló eltávolítása

- ▶ 1. Döntse előre a kihúzható tárolót (1).
- ▶ 2. Távolítsa el a kihúzható tárolót (2).

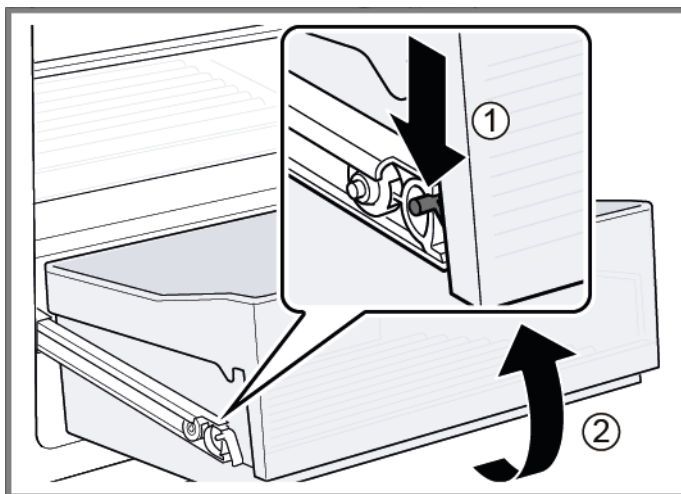



- ➡ Eltávolította a kihúzható tárolót.

### 4.12.2 A kihúzható tároló behelyezése

- ▶ Az elhelyezést fordított sorrendben végezze.

## 4.13 LED-es oldalsó spotvilágítás cseréje

### Különleges eszközök

-  Különleges szerszám [00342180]
-  Laposfejű csavarhúzó Hegy 2,4 mm x 0,4 mm x 60 mm, a készletben [00341820]

 A készüléke karbantartásmentes LED-világítással rendelkezik. A világítást kizárólag az ügyfélszolgálat vagy szakképzett technikusok javíthatják meg!

 **⚠ VESZÉLY**  
**Áramütés veszélye áram alatt lévő alkatrészek miatt!**  
 Életveszély a nem megfelelő javítás okozta áramütés miatt

- ▶ Az elektromos alkatrészek javítását kizárólag képzett elektroműszerész végezheti.
- ▶ A javítás után végeztesen a VDE 0701-nek vagy az országspecifikus szabályozásoknak megfelelő vizsgálatot.



 **⚠ VESZÉLY**  
**Áramütés veszélye áram alatt lévő alkatrészek miatt!**  
 Halálos áramütés

- ▶ A javítás megkezdése előtt legalább 60 másodperccel válassza le a készülékeket az elektromos hálózatról.

 **⚠ VIGYÁZAT**  
**Éles szélek!**  
 Vágási sérülések

- ▶ Viseljen védőkesztyűt.

### Követelmény:

-  A készüléket leválasztotta az áramellátásról.
-  Az ajtó nyitva van
-  Eltávolította a hűtőszekrény polcait.

### 4.13.1 LED-es spotvilágítás eltávolítása

1. Oldja ki a LED-es spotvilágítás burkolatát.

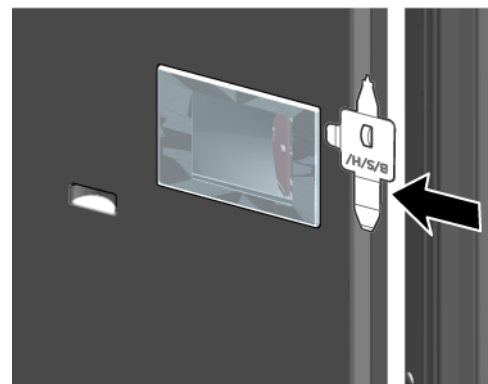

2. Húzza befelé a LED-es spotvilágítás burkolatát, és ezzel egyidejűleg tolja előre.

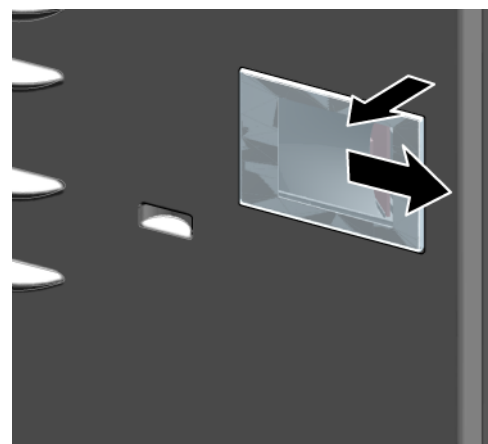



3. Válassza le a LED-es spotvilágítás modulját.

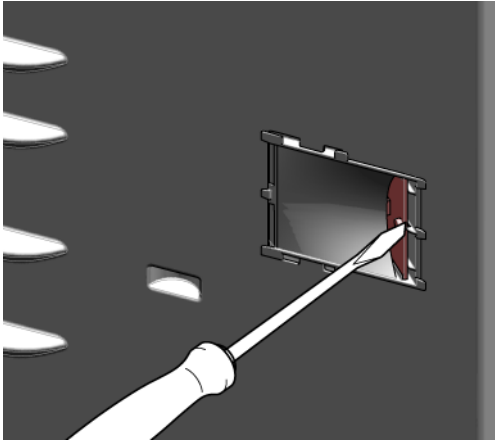

4. Válassza le a LED-es spotvilágítás elektromos csatlakozását.

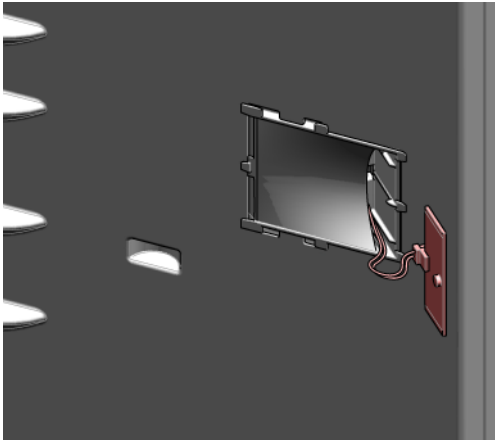





-  Eltávolította a LED-es spotvilágítást.

### 4.13.2 A LED-es spotvilágítás beszerelése

- ▶ Az elhelyezést fordított sorrendben végezze.

# Consigli di riparazione - Combinazione frigorifero / congelatore

 <b>Utilizzo del documento</b> .....	<b>291</b>
1.1 Avvertenze importanti .....	291
1.1.1 Scopo .....	291
1.2 Spiegazione dei simboli .....	291
1.2.1 Livelli di pericolo .....	291
1.2.2 Simboli di pericolo .....	291
1.2.3 Struttura degli avvertimenti .....	292
1.2.4 Simboli generici .....	292
 <b>Sicurezza</b> .....	<b>293</b>
2.1 Note generali sulla sicurezza .....	293
2.1.1 Tutti gli elettrodomestici .....	293
 <b>Strumenti e ausili</b> .....	<b>294</b>
 <b>Riparazione</b> .....	<b>295</b>
4.1 Sostituzione della guarnizione della porta .....	295
4.1.1 Smontaggio della guarnizione della porta .....	295
4.1.2 Montaggio della guarnizione della porta .....	295
4.2 Sostituzione della cerniera piatta .....	298
4.2.1 Smontaggio della cerniera piatta .....	298
4.2.2 Montaggio della cerniera piatta .....	300
4.3 Sostituzione della cerniera scorrevole .....	301
4.3.1 Smontaggio della cerniera scorrevole .....	301
4.3.2 Montaggio della cerniera scorrevole .....	302
4.4 Sostituzione del balconcino della porta .....	303
4.4.1 Smontaggio del balconcino della porta .....	303
4.4.2 Montaggio del balconcino della porta .....	303
4.5 Sostituzione del ripiano .....	304
4.5.1 Smontaggio del ripiano .....	304
4.5.2 Montaggio del ripiano .....	304
4.6 Sostituzione del ripiano estraibile .....	305
4.6.1 Rimozione del ripiano estraibile .....	305
4.6.2 Inserimento del ripiano estraibile .....	305
4.7 Sostituzione del ripiano del comparto freezer .....	306
4.7.1 Rimozione del ripiano del comparto freezer .....	306
4.7.2 Inserimento del ripiano del comparto freezer .....	306
4.8 Sostituzione del cassetto surgelati .....	307
4.8.1 Rimozione del cassetto surgelati .....	307
4.8.2 Inserimento del cassetto surgelati .....	307
4.9 Sostituzione del cassetto frutta e verdura .....	308
4.9.1 Rimozione del cassetto frutta e verdura .....	308
4.9.2 Inserimento del cassetto frutta e verdura .....	308
4.10 Sostituzione della divisoria e del coperchio del cassetto frutta e verdura .....	309
4.10.1 Smontaggio della divisoria e del coperchio del cassetto frutta e verdura .....	309
4.10.2 Montaggio della divisoria e del coperchio del cassetto frutta e verdura .....	309
4.11 Sostituzione del cassetto a 0 °C .....	310
4.11.1 Estrazione del cassetto a 0 °C .....	310
4.11.2 Inserimento del cassetto a 0 °C .....	310
4.12 Sostituzione del cassetto estraibile .....	311
4.12.1 Rimozione del cassetto estraibile .....	311
4.12.2 Inserimento del cassetto estraibile .....	311
4.13 Sostituzione del faretto a LED .....	312
4.13.1 Smontaggio del faretto a LED .....	312
4.13.2 Montaggio del faretto a LED .....	313

# **i** Utilizzo del documento

## 1.1 Avvertenze importanti

### 1.1.1 Scopo

Queste istruzioni di riparazione spiegano ai clienti come riparare da soli gli elettrodomestici in conformità alle regole sull'Ecodesign vigenti (al 03/2021).

Contengono informazioni sulla sostituzione di pezzi di ricambio specifici e sulle avvertenze e i rischi correlati.

In caso di domande, contattare l'assistenza tecnica. Il mancato rispetto di tali istruzioni da parte dei clienti ci esonera da qualsiasi responsabilità.

## 1.2 Spiegazione dei simboli

### 1.2.1 Livelli di pericolo

I livelli di avvertimento corrispondono a un simbolo accompagnato da una parola di allerta. La parola di allerta identifica il livello di pericolo.





Livello di avvertimento	Significato
	Ignorare questo messaggio di avvertimento comporta rischio di morte o ferite gravi.
	Ignorare questo messaggio di avvertimento può comportare rischio di morte o ferite gravi.
	Ignorare questo messaggio di avvertimento può comportare ferite di minore gravità.
	Ignorare questo messaggio di avvertimento può comportare danni materiali.

Tabella 1: Livelli di pericolo

### 1.2.2 Simboli di pericolo

I simboli di pericolo sono illustrazioni che specificano la tipologia di rischio.

Nella presente documentazione vengono utilizzati i seguenti simboli di pericolo:

Simbolo di pericolo	Significato
	Messaggio di avvertimento generico
	Pericolo di scossa elettrica
	Pericolo di esplosione
	Rischio di ferite da taglio

## Utilizzo del documento





Simbolo di pericolo	Significato
	Pericolo di schiacciamento
	Pericolo derivante da superfici calde
	Pericolo derivante da forti campi magnetici
	Pericolo derivante da radiazioni non ionizzanti

Tabella 2: Simboli di pericolo

### 1.2.3 Struttura degli avvertimenti

Gli avvertimenti presenti in questo manuale hanno una forma e una struttura standardizzati.

	<p> <b>PERICOLO</b></p> <p><b>Tipo e origine del pericolo!</b> Possibili conseguenze in caso di pericolo/avvertimento ignorato.</p> <ul style="list-style-type: none"> <li>▶ Misure e divieti volti a prevenire il pericolo.</li> </ul>
--	--

L'esempio seguente mostra un avvertimento con rischio di folgorazione dovuto a componenti sotto tensione. È riportata la misura di precauzione per evitare il pericolo.

	<p> <b>PERICOLO</b></p> <p><b>Rischio di scossa elettrica dovuto a componenti sotto tensione!</b> Morte per folgorazione</p> <ul style="list-style-type: none"> <li>▶ Scollegare l'apparecchio dall'alimentazione per almeno 60 secondi prima di iniziare la riparazione.</li> </ul>
--	---

### 1.2.4 Simboli generici

Nel presente manuale vengono utilizzati i seguenti simboli generici:





Simbolo generico	Significato
	Identificazione di un suggerimento speciale (testo e/o grafica)
	Identificazione di un suggerimento semplice (solo testo)
	Identificazione di un link per un video tutorial
	Identificazione degli strumenti necessari
	Identificazione delle condizioni preve necessarie
	Identificazione di una condizione (se ..., allora ...)
	Identificazione di un risultato
[Avvio]	Identificazione di un tasto o di un pulsante
[00123456]	Identificazione di un codice articolo
Stato	Identificazione di un testo/finestra visualizzati (sul display dell'apparecchio)

Tabella 3: Simboli generici

## 2.1 Note generali sulla sicurezza

### 2.1.1 Tutti gli elettrodomestici

#### **Rischio di scosse elettriche dovute a componenti sotto tensione!**

- La riparazione non conforme dei componenti elettrici può causare scosse elettriche!
- Scollegare l'apparecchio dall'alimentazione per almeno 60 secondi prima di iniziare il lavoro.
- Ultimata la riparazione, occorre eseguire un test di sicurezza conforme alla norma VDE 0701 o alle norme specifiche del Paese.

#### **Rischio di lesioni causate da bordi taglienti!**

- Indossare guanti di protezione.

#### **Rischio di schiacciamento dovuto a componenti pesanti e in movimento durante la riparazione, la manutenzione, la ricerca dei guasti e l'assistenza**

- Indossare calzature antinfortunistiche.
- Fissare i componenti pesanti per impedire che cadano.
- Non inserire parti del corpo nei componenti in movimento.



#### **Rischio per il funzionamento o la sicurezza dell'apparecchio!**

- Utilizzare solo ricambi originali.

#### **Rischio di danneggiamento di componenti sensibili a carica elettrostatica (ESD)!**

- Non toccare i moduli, inclusi i collegamenti e le piste conduttive.

## Strumenti e ausili

Designazione	Dettagli	Immagini
Panno di protezione [00342013]	60 cm x 50 cm	
Punta Torx TX20 [00340865]	6,3 mm (1/4")	
Utensile speciale [00342180]		

## 4.1 Sostituzione della guarnizione della porta

### Prerequisiti:

- ✔ La porta è aperta.

### 4.1.1 Smontaggio della guarnizione della porta

1. Staccare la guarnizione della porta dalla scanalatura negli angoli destro e sinistro.

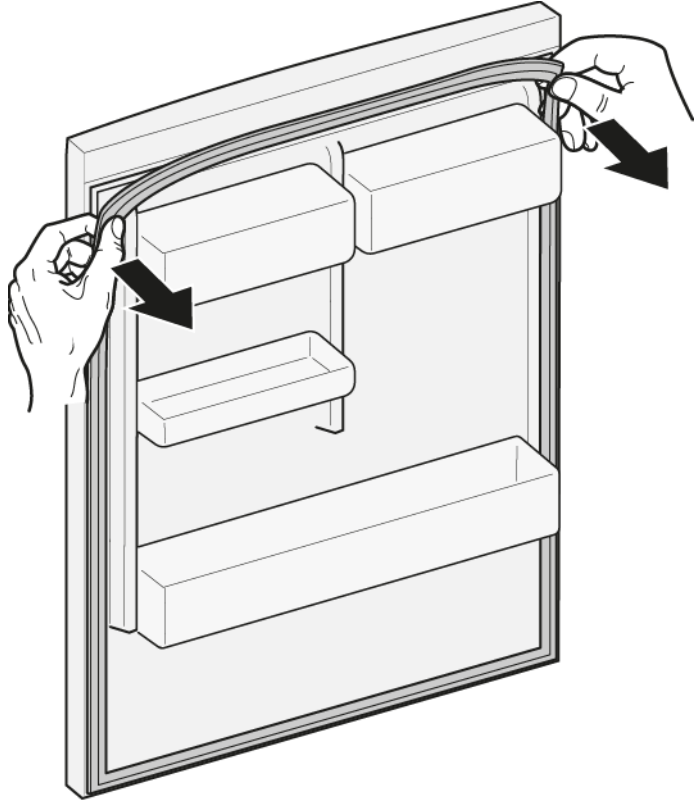

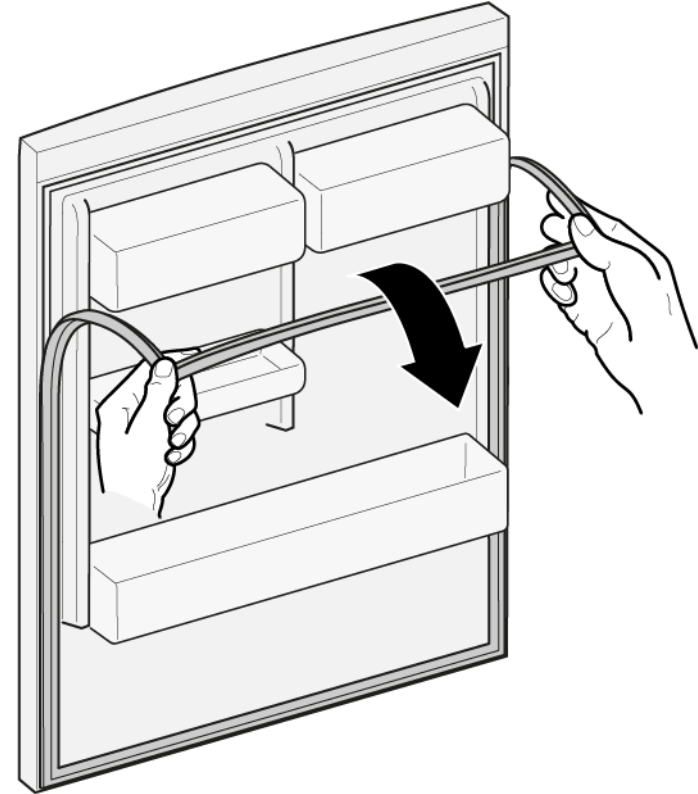

2. Estrarre la guarnizione della porta dalla scanalatura.



- ➡ La guarnizione della porta è rimossa.

### 4.1.2 Montaggio della guarnizione della porta

	Lo spessore della nuova guarnizione della porta può essere leggermente diverso dallo spessore di quella vecchia. Ciò non incide sulla chiusura e sul funzionamento a lungo termine.
	Se l'apparecchio è dotato di cerniere regolabili o accessori, è possibile ottimizzare il comportamento di chiusura.
	I piccoli fori laterali nella guarnizione della porta sono funzionali (necessari per la ventilazione). Non si tratta di difetti di produzione.

## Riparazione

1. Controllare che la scanalatura della guarnizione non sia danneggiata.

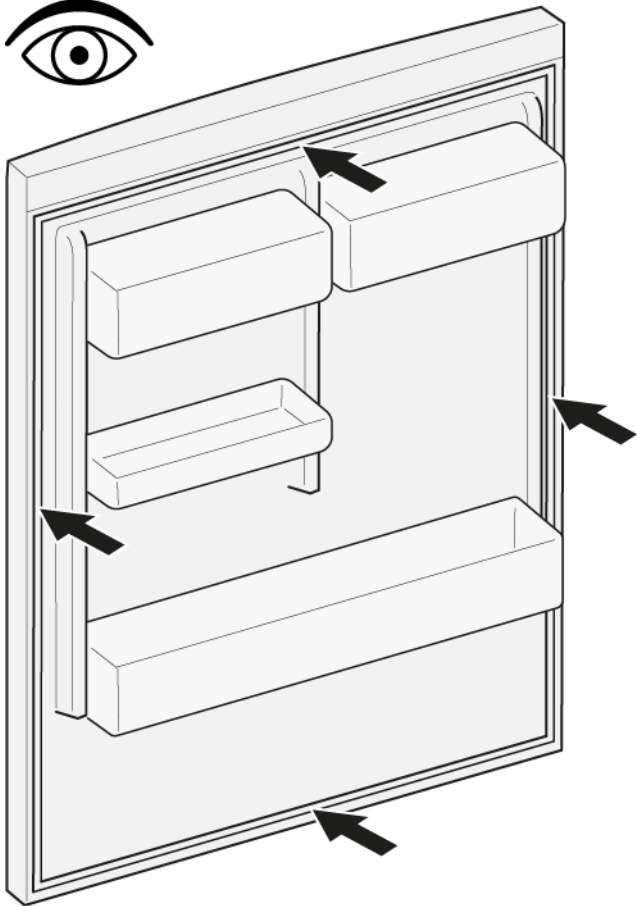

4. Spingere gli angoli della guarnizione nella scanalatura in alto e in basso.

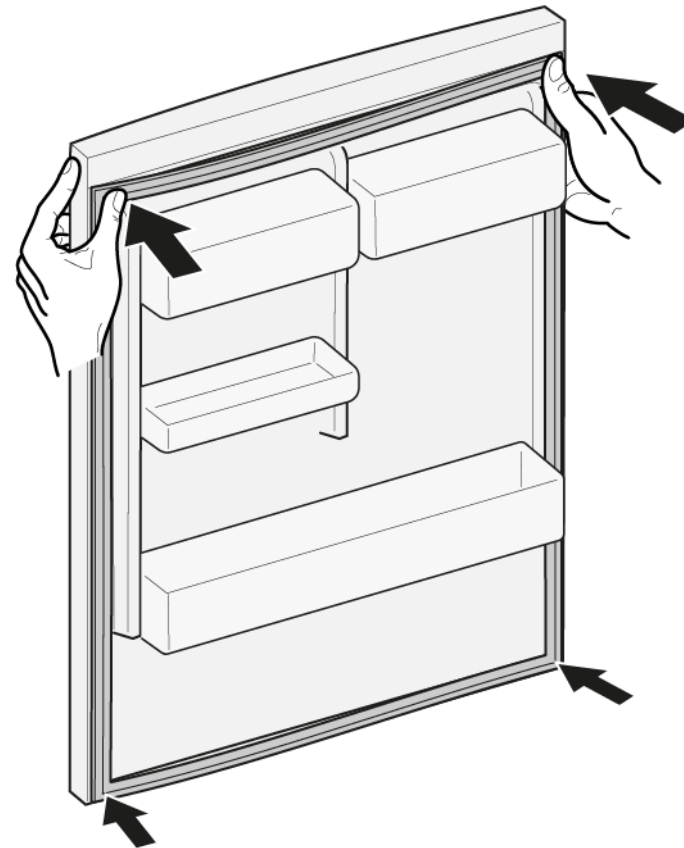

2.  Se la scanalatura della guarnizione è danneggiata.  
- Contattare l'assistenza tecnica.

3.  Una leggera deformazione della guarnizione della porta è normale e non incide sul funzionamento. Si consiglia di raddrizzare la guarnizione della porta prima di inserirla nell'apparecchio.

Riscaldare la guarnizione della porta con un asciugacapelli o acqua calda e ridarle la forma manualmente.



## Riparazione

5. Premere la guarnizione nella scanalatura un pezzo per volta.

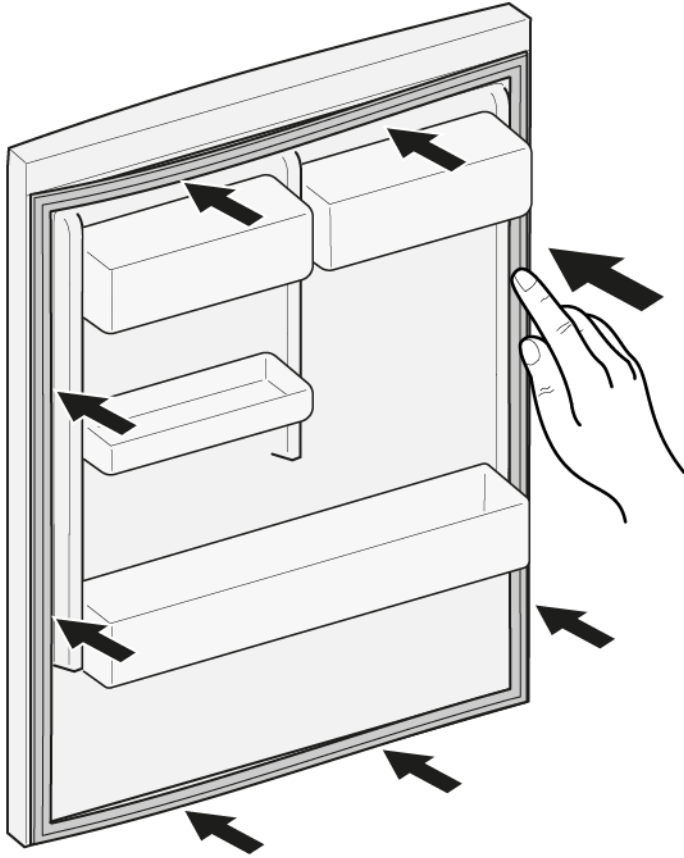



-  La guarnizione della porta è montata.

## 4.2 Sostituzione della cerniera piatta

### Attrezzi speciali:

 Punta Torx TX20      6,3 mm (1/4")      [00340865]

	<b>⚠ AVVERTENZA</b>
	<p><b>Apparecchi pesanti, ingombranti!</b>                  Rischio di infortuni muscolari e alla schiena</p> <ul style="list-style-type: none"> <li>▶ L'operazione di smontaggio della porta dell'apparecchio deve essere eseguita soltanto da tecnici addestrati.</li> <li>▶ Spostare l'apparecchio in due persone.</li> <li>▶ Usare solo utensili e attrezzature idonei.</li> </ul>



	<b>⚠ ATTENZIONE</b>
	<p><b>Bordi taglienti!</b>                  Ferite da taglio</p> <ul style="list-style-type: none"> <li>▶ Indossare guanti di protezione.</li> </ul>

	<b>⚠ ATTENZIONE</b>
	<p><b>Zona della cerniera aperta!</b>                  Rischio di schiacciamento delle dita / di rimanere incastrati</p> <ul style="list-style-type: none"> <li>▶ Non inserire le dita nella zona della cerniera.</li> <li>▶ Indossare guanti di protezione.</li> </ul>



	<b>⚠ ATTENZIONE</b>
	<p><b>Rischio di caduta di componenti a causa di viti allentate!</b>                  Lesioni provocate dalla caduta di componenti.</p> <ul style="list-style-type: none"> <li>▶ Fissare i componenti in modo che non cadano.</li> </ul>

	<b>ATTENZIONE!</b>
	<p><b>Rischio di caduta di componenti a causa di viti allentate!</b>                  Danni a altre parti dell'apparecchio o all'abitazione del cliente, ad es. parte inferiore.</p> <ul style="list-style-type: none"> <li>▶ Fissare i componenti in modo che non cadano.</li> </ul>

### Prerequisiti:

-  L'apparecchio è scollegato dalla rete elettrica.
-  Il pannello della porta è rimosso. Vedere le Istruzioni di installazione.
-  La porta è aperta.

### 4.2.1 Smontaggio della cerniera piatta

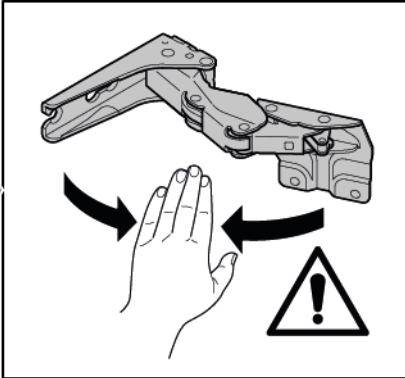
	Prestare attenzione che le cerniere non si chiudano durante lo smontaggio / rimontaggio.	
		

1. Togliere le coperture delle quattro cerniere.

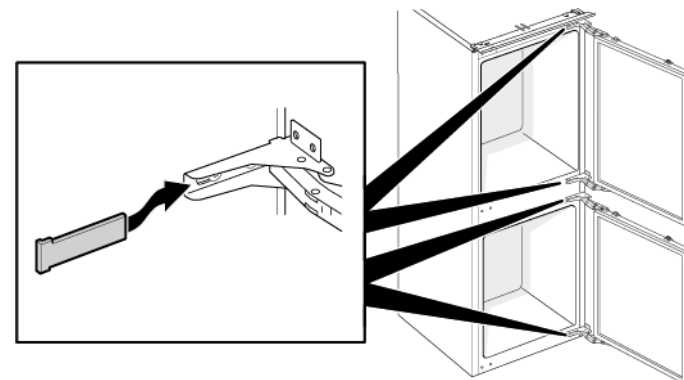

## Riparazione

2. 1. Svitare le quattro viti (1).  
2. Far scorrere e rimuovere la porta superiore (2).

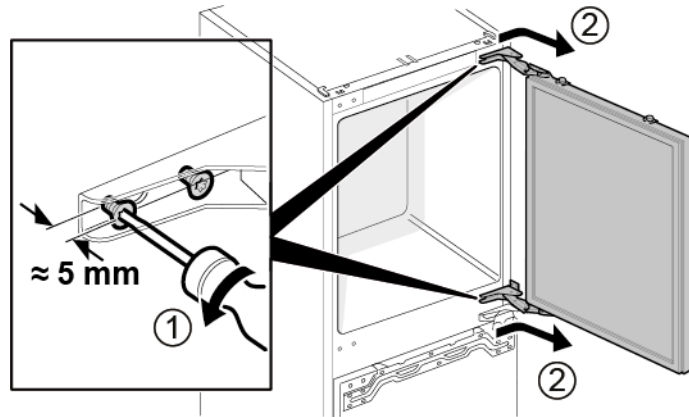

3. 1. Togliere le quattro viti (1).  
2. Togliere le cerniere (2).

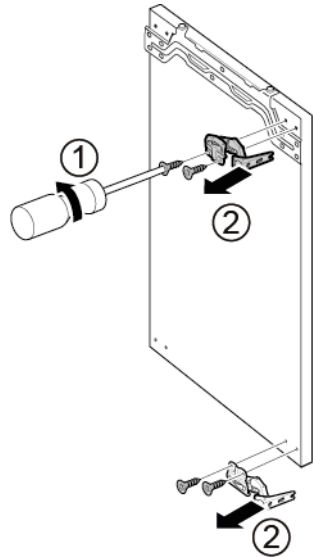

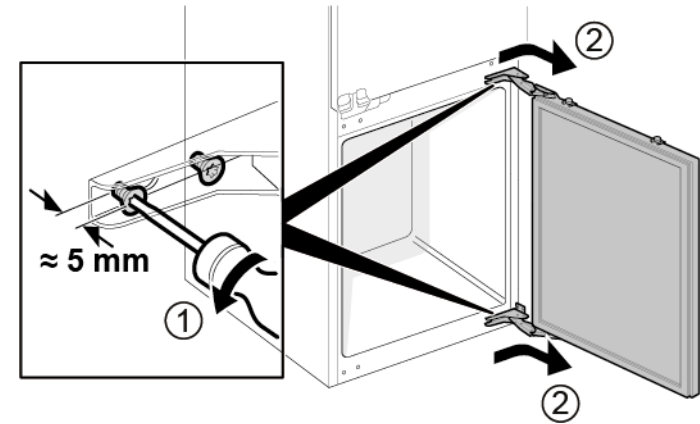

 Le cerniere superiori della porta sono rimosse.

4. 1. Svitare le quattro viti (1).  
2. Far scorrere e rimuovere la porta inferiore (2).

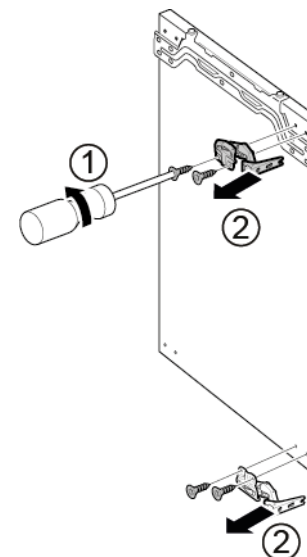

5. 1. Togliere le quattro viti (1).  
2. Togliere le cerniere (2).



 Le cerniere inferiori della porta sono rimosse.

### 4.2.2 Montaggio della cerniera piatta

- ▶ Per il montaggio, seguire la procedura sopra descritta in senso opposto.

## 4.3 Sostituzione della cerniera scorrevole

### Attrezzi speciali:

 Punta Torx TX20      6,3 mm (1/4")      [00340865]



	<b>⚠ AVVERTENZA</b>
	<b>Apparecchi pesanti, ingombranti!</b> Rischio di infortuni muscolari e alla schiena <ul style="list-style-type: none"><li>▶ L'operazione di smontaggio della porta dell'apparecchio deve essere eseguita soltanto da tecnici addestrati.</li><li>▶ Spostare l'apparecchio in due persone.</li><li>▶ Usare solo utensili e attrezzature idonei.</li></ul>

	<b>⚠ ATTENZIONE</b>
	<b>Bordi taglienti!</b> Ferite da taglio <ul style="list-style-type: none"><li>▶ Indossare guanti di protezione.</li></ul>

	<b>⚠ ATTENZIONE</b>
	<b>Rischio di caduta di componenti a causa di viti allentate!</b> Lesioni provocate dalla caduta di componenti. <ul style="list-style-type: none"><li>▶ Fissare i componenti in modo che non cadano.</li></ul>

	<b>ATTENZIONE!</b>
	<b>Rischio di caduta di componenti a causa di viti allentate!</b> Danni a altre parti dell'apparecchio o all'abitazione del cliente, ad es. parte inferiore. <ul style="list-style-type: none"><li>▶ Fissare i componenti in modo che non cadano.</li></ul>

### Prerequisiti:

-  L'apparecchio è scollegato dalla rete elettrica.
-  Il pannello della porta e la porta dell'apparecchio sono separate. Vedere le Istruzioni di installazione.

### 4.3.1 Smontaggio della cerniera scorrevole

1. 1. Svitare le due viti (1).
2. 2. Rimuovere la cerniera superiore della porta superiore (2).
3. 3. Togliere la porta superiore (3).
4. 4. Svitare le due viti (4).
5. 5. Rimuovere la cerniera superiore della porta inferiore (5).
6. 6. Togliere la porta inferiore (6).

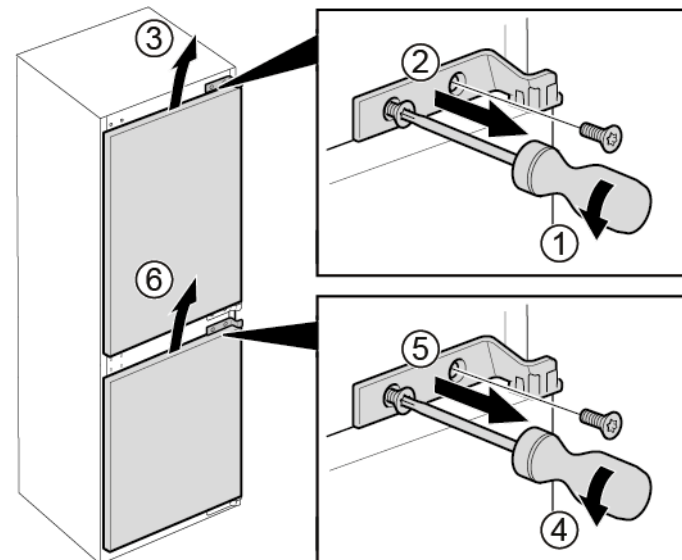

## Riparazione

2. 1. Togliere le quattro viti (1).
2. Togliere le cerniere inferiori (2).

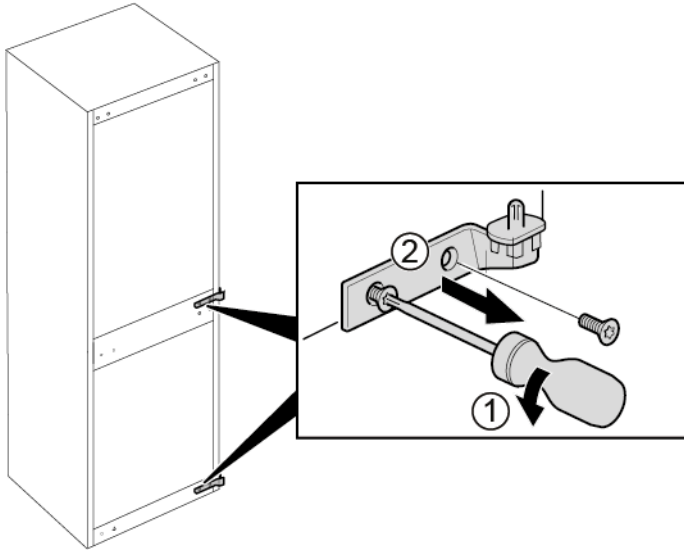

 Le cerniere sono rimosse.

### 4.3.2 Montaggio della cerniera scorrevole

- ▶ Per il montaggio, seguire la procedura sopra descritta in senso opposto.

### 4.4 Sostituzione del balconcino della porta

#### Prerequisiti:

- ✔ La porta è aperta.

#### 4.4.1 Smontaggio del balconcino della porta

- ▶ Tirare il balconcino della porta verso l'alto.

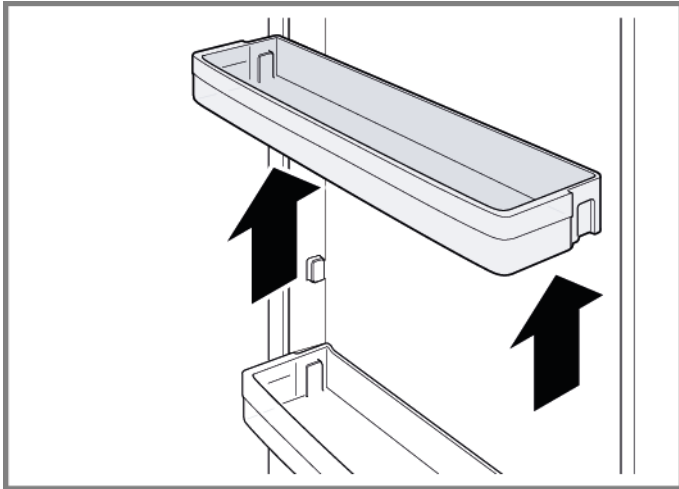

➡ Il balconcino della porta è rimosso.

#### 4.4.2 Montaggio del balconcino della porta

- ▶ Per il montaggio, seguire la procedura sopra descritta in senso opposto.

## 4.5 Sostituzione del ripiano

### Prerequisiti:

- ✔ La porta è aperta.

### 4.5.1 Smontaggio del ripiano

- ▶ Estrarre il ripiano.

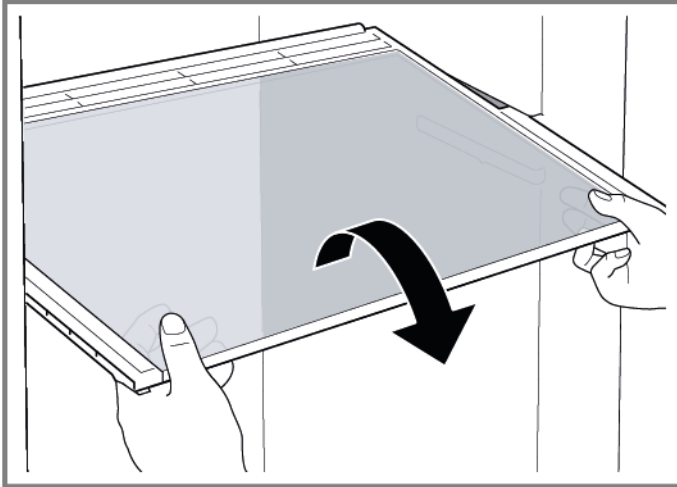

- ➡ Il ripiano è rimosso.

### 4.5.2 Montaggio del ripiano

- ▶ Per il montaggio, seguire la procedura sopra descritta in senso opposto.



## 4.6 Sostituzione del ripiano estraibile

### Prerequisiti:

- ✔ La porta è aperta.

### 4.6.1 Rimozione del ripiano estraibile

1. Estrarre il ripiano estraibile fino a sganciare il fermo.

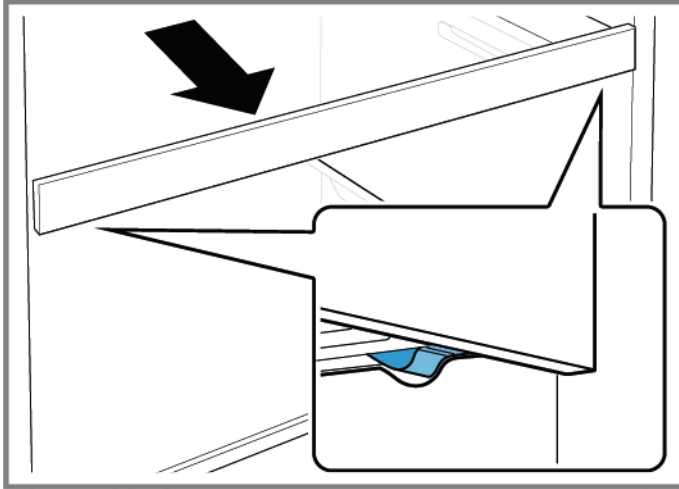

2. Abbassare il ripiano estraibile e girarlo di lato.
3. ➡ Il ripiano estraibile è rimosso.

### 4.6.2 Inserimento del ripiano estraibile

- ▶ Per il montaggio, seguire la procedura sopra descritta in senso opposto.

## 4.7 Sostituzione del ripiano del comparto freezer

### Prerequisiti:

- ✔ La porta è aperta.

### 4.7.1 Rimozione del ripiano del comparto freezer

- ▶ Estrarre il ripiano del comparto freezer.

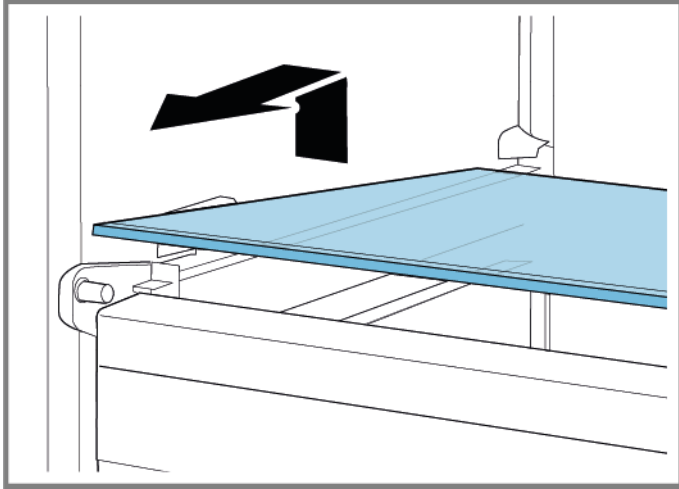

- ➡ Il ripiano del comparto freezer è rimosso.

### 4.7.2 Inserimento del ripiano del comparto freezer

- ▶ Per il montaggio, seguire la procedura sopra descritta in senso opposto.

## 4.8 Sostituzione del cassetto surgelati

### Prerequisiti:

- ✔ La porta è aperta.

### 4.8.1 Rimozione del cassetto surgelati

- ▶ 1. Estrarre completamente il cassetto surgelati (1).
- ▶ 2. Togliere il cassetto surgelati (2).

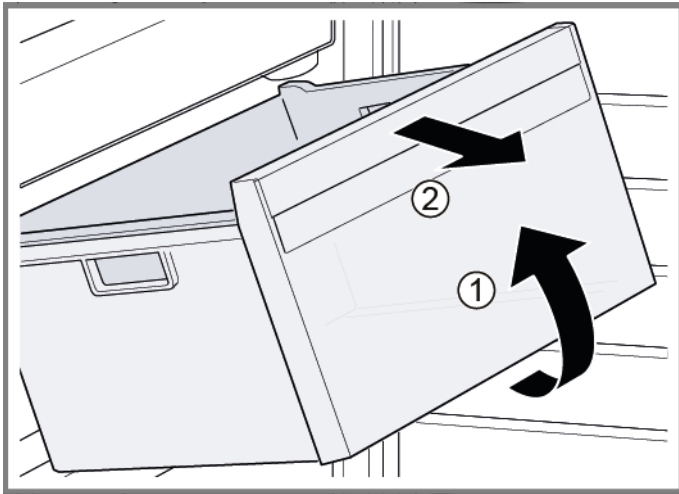

- ➡ Il cassetto surgelati è rimosso.

### 4.8.2 Inserimento del cassetto surgelati

- ▶ Per il montaggio, seguire la procedura sopra descritta in senso opposto.

## 4.9 Sostituzione del cassetto frutta e verdura

### Prerequisiti:

- ✔ La porta è aperta.

### 4.9.1 Rimozione del cassetto frutta e verdura

- ▶ 1. Estrarre completamente il cassetto (1).
- ▶ 2. Rimuovere il cassetto (2).

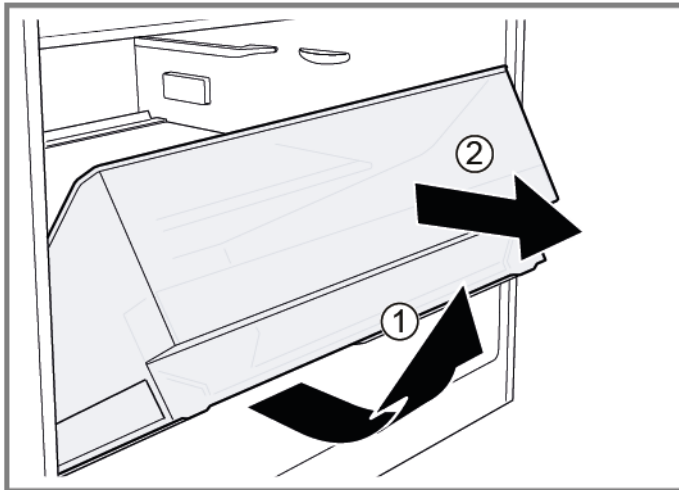

- ➡ Il cassetto è rimosso.

### 4.9.2 Inserimento del cassetto frutta e verdura

- ▶ Per il montaggio, seguire la procedura sopra descritta in senso opposto.

### 4.10 Sostituzione della divisoria e del coperchio del cassetto frutta e verdura

#### Prerequisiti:

- ✔ La porta è aperta.

#### 4.10.1 Smontaggio della divisoria e del coperchio del cassetto frutta e verdura

1. Togliere la lastra di vetro dalla divisoria.

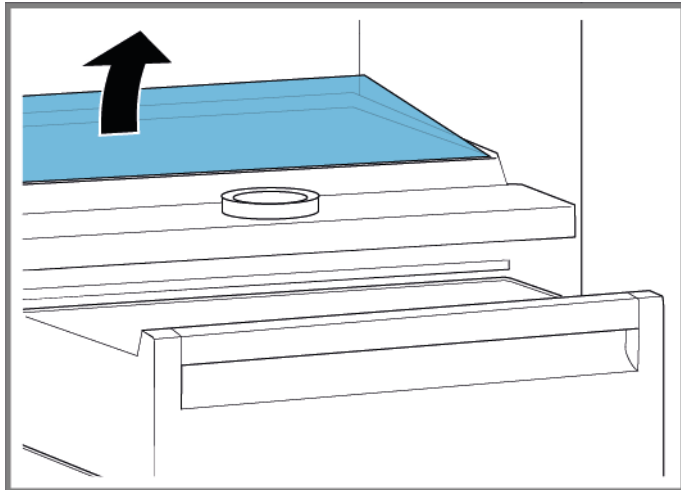

2. [Togliere il cassetto frutta e verdura. → 308](#)

3. 1. Premere la leva nella parte inferiore di entrambi i lati della divisoria (1).
2. Tirare la divisoria in avanti (2).

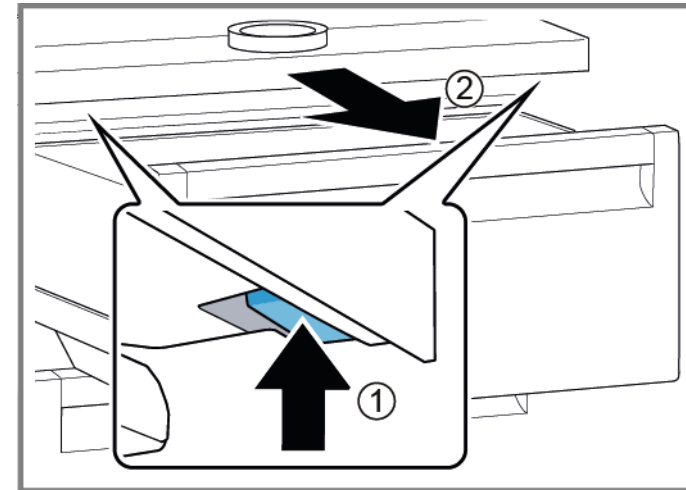

4. Sollevare la divisoria e ruotarla di lato.  
➡ La divisoria è rimossa.
5. 1. Sollevare il coperchio del cassetto frutta e verdura.  
2. Tirare il coperchio del cassetto frutta e verdura in avanti e girarlo di lato.  
➡ Il coperchio del cassetto frutta e verdura è rimosso.

#### 4.10.2 Montaggio della divisoria e del coperchio del cassetto frutta e verdura

- ▶ Per il montaggio, seguire la procedura sopra descritta in senso opposto.

### 4.11 Sostituzione del cassetto a 0 °C

#### Prerequisiti:

- ✔ La porta è aperta.

#### 4.11.1 Estrazione del cassetto a 0 °C

- ▶ 1. Inclinare il cassetto a 0 °C in avanti (1).
- ▶ 2. Togliere il cassetto a 0 °C (2).

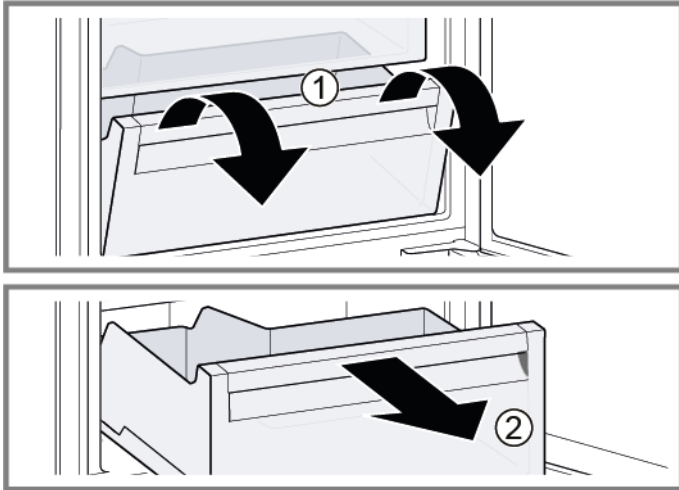

➡ Il cassetto a 0 °C è rimosso.

#### 4.11.2 Inserimento del cassetto a 0 °C

- ▶ Per il montaggio, seguire la procedura sopra descritta in senso opposto.

## 4.12 Sostituzione del cassetto estraibile

### Prerequisiti:

- ✔ La porta è aperta.

### 4.12.1 Rimozione del cassetto estraibile

- ▶ 1. Inclinare il cassetto estraibile in avanti (1).
- ▶ 2. Togliere il cassetto estraibile (2).

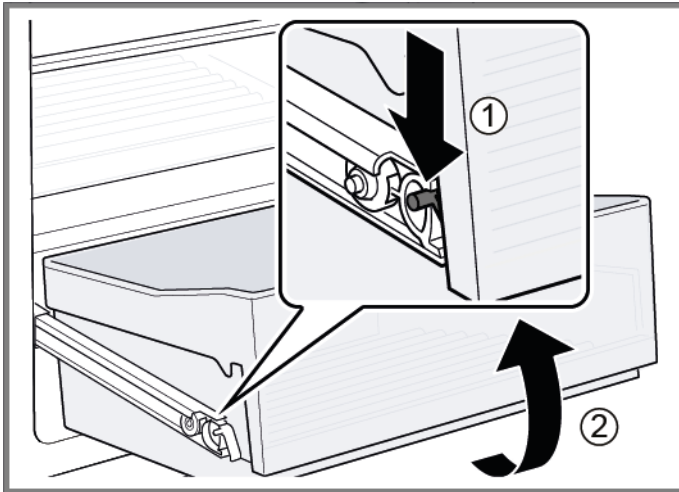



➡ Il cassetto estraibile è rimosso.

### 4.12.2 Inserimento del cassetto estraibile

- ▶ Per il montaggio, seguire la procedura sopra descritta in senso opposto.

## 4.13 Sostituzione del faretto a LED

### Attrezzi speciali:

-  Utensile speciale [00342180]
-  Cacciavite a taglio Lama 2,4 mm x 0,4 mm x 60 mm, nel kit [00341820]

 L'apparecchio è dotato di una luce a LED esente da manutenzione. Queste luci possono essere riparate esclusivamente dall'assistenza clienti o da tecnici autorizzati!

 **PERICOLO**  
**Rischio di scosse elettriche dovute a componenti sotto tensione!**  
Pericolo di morte dovuto a scosse elettriche in caso di riparazione non conforme

- ▶ Le parti elettriche devono essere riparate da elettricisti qualificati.
- ▶ Ultimata la riparazione, occorre eseguire un test di sicurezza conforme alla norma VDE 0701 o alle norme specifiche del Paese.



 **PERICOLO**  
**Rischio di scossa elettrica dovuto a componenti sotto tensione!**  
Morte per folgorazione

- ▶ Scollegare l'apparecchio dall'alimentazione per almeno 60 secondi prima di iniziare la riparazione.

 **ATTENZIONE**  
**Bordi taglienti!**  
Ferite da taglio

- ▶ Indossare guanti di protezione.

### Prerequisiti:

-  L'apparecchio è scollegato dalla rete elettrica.
-  La porta è aperta.
-  I ripiani del comparto frigorifero sono rimossi.

### 4.13.1 Smontaggio del faretto a LED

1. Sganciare il coperchio del faretto a LED.

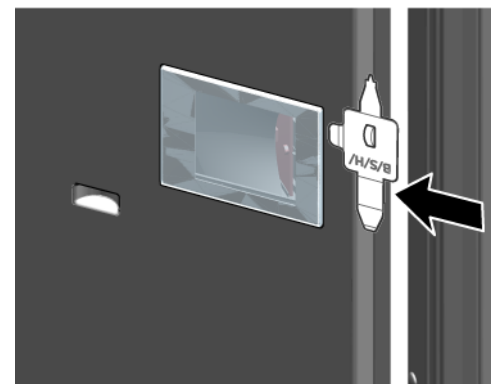

2. Tirare il coperchio del faretto a LED all'interno e contemporaneamente spingerlo in avanti.

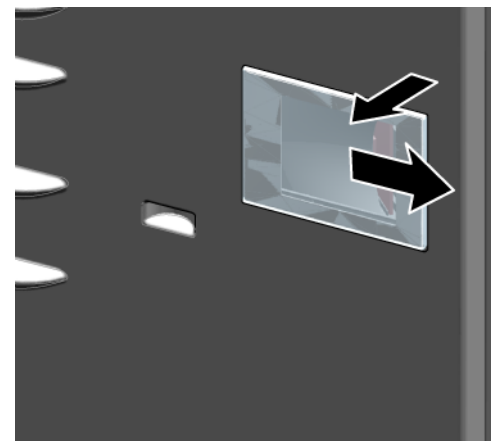



3. Staccare il modulo del faretto a LED.

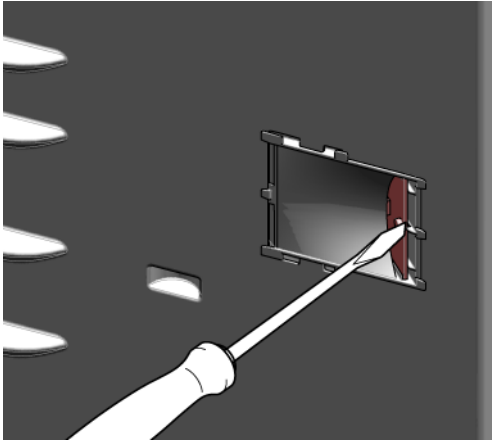

4. Staccare il collegamento elettrico del faretto a LED.

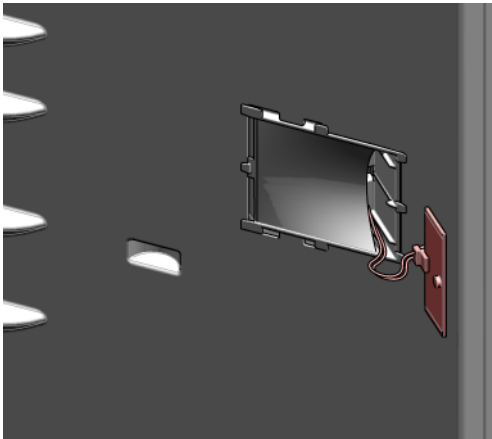





-  Il faretto a LED è rimosso.

### 4.13.2 Montaggio del faretto a LED

- ▶ Per il montaggio, seguire la procedura sopra descritta in senso opposto.

# Informācija par remontu - Dzesēšanas un saldēšanas kombinācija

 <b>Par šo dokumentu</b> .....	<b>315</b>	4.8 Saldētās pārtikas tvertnes nomaiņa.....	331
1.1 Būtiska informācija .....	315	4.8.1 Saldētās pārtikas tvertnes izņemšana .....	331
1.1.1 Mērķis .....	315	4.8.2 Saldētās pārtikas tvertnes uzstādīšana .....	331
1.2 Simbolu skaidrojums.....	315	4.9 Augļu un dārzeņu tvertnes nomaiņa .....	332
1.2.1 Bīstamības līmeņi .....	315	4.9.1 Augļu un dārzeņu tvertnes izņemšana .....	332
1.2.2 Bīstamības simboli .....	315	4.9.2 Augļu un dārzeņu tvertnes uzstādīšana .....	332
1.2.3 Brīdinājumu struktūra .....	316	4.10 Starplikas un augļu un dārzeņu tvertnes vāka nomaiņa .....	333
1.2.4 Vispārīgie simboli.....	316	4.10.1 Starplikas izņemšana un augļu un dārzeņu tvertnes vāka noņemšana.....	333
 <b>Drošība</b> .....	<b>317</b>	4.10.2 Starplikas un augļu un dārzeņu tvertnes vāka uzstādīšana .....	333
2.1 Vispārējie drošības norādījumi .....	317	4.11 Svaiguma saglabāšanas tvertnes nomaiņa .....	334
2.1.1 Visām mājsaimniecības ierīcēm .....	317	4.11.1 Svaiguma saglabāšanas tvertnes izņemšana .....	334
 <b>Piederumi un palīgīdzekļi</b> .....	<b>318</b>	4.11.2 Svaiguma saglabāšanas tvertnes uzstādīšana .....	334
 <b>Remonts</b> .....	<b>319</b>	4.12 Izvelkamās tvertnes nomaiņa.....	335
4.1 Durvju blīvslēga nomaiņa .....	319	4.12.1 Izvelkamās tvertnes izņemšana .....	335
4.1.1 Durvju blīvslēga noņemšana .....	319	4.12.2 Izvelkamās tvertnes uzstādīšana .....	335
4.1.2 Durvju blīvslēga uzstādīšana .....	319	4.13 LED starmeša nomaiņa .....	336
4.2 Plakanās viras nomaiņa .....	322	4.13.1 LED starmeša noņemšana .....	336
4.2.1 Plakanās viras noņemšana .....	322	4.13.2 LED starmeša uzstādīšana .....	337
4.2.2 Plakanās viras uzstādīšana .....	324		
4.3 Slīdošās viras nomaiņa .....	325		
4.3.1 Slīdošās viras noņemšana .....	325		
4.3.2 Slīdošās viras uzstādīšana .....	326		
4.4 Durvju plaukta nomaiņa .....	327		
4.4.1 Durvju plaukta noņemšana .....	327		
4.4.2 Durvju plaukta uzstādīšana.....	327		
4.5 Plaukta nomaiņa.....	328		
4.5.1 Plaukta izņemšana .....	328		
4.5.2 Plaukta uzstādīšana .....	328		
4.6 Izvelkamā plaukta nomaiņa .....	329		
4.6.1 Izvelkamā plaukta izņemšana .....	329		
4.6.2 Izvelkamā plaukta uzstādīšana .....	329		
4.7 Saldētavas nodalījuma plaukta nomaiņa .....	330		
4.7.1 Saldētavas nodalījuma plaukta izņemšana .....	330		
4.7.2 Saldētavas nodalījuma plaukta uzstādīšana .....	330		

# **i** Par šo dokumentu

## 1.1 Būtiska informācija

### 1.1.1 Mērķis

Šie labošanas ieteikumi ir paredzēti patērētājam, patstāvīgi labojot ierīces, saskaņā ar piemērojamo Ekodizaina regulu (sākot no 03.2021.).





Tajā ir sniegta informācija par to, kā nomainīt noteiktas rezerves daļas, kā arī brīdinājumi un riski.

Jautājumu gadījumā lūdzam sazināties ar mūsu klientu apkalpošanas dienestu. Mēs esam atbildīgi par zaudējumiem tikai tad, ja ir pienācīgi ievēroti šie labošanas ieteikumi.

## 1.2 Simbolu skaidrojums

### 1.2.1 Bīstamības līmeņi

Brīdinājuma līmeņus veido simbols un signālvārds. Signālvārds apzīmē bīstamības pakāpi.





Brīdinājuma līmenis	Nozīme
 <b>BĪSTAMI</b>	Brīdinājuma paziņojuma neievērošanas rezultātā iestāsies nāve vai radīsies smagas traumas.
 <b>BRĪDINĀJUMS</b>	Brīdinājuma paziņojuma neievērošanas rezultātā var iestāties nāve vai rasties smagas traumas.
 <b>ESJET PIESARDŽĪGI</b>	Brīdinājuma paziņojuma neievērošanas rezultātā var rasties nelielas traumas.
 <b>UZMANĪBU!</b>	Brīdinājuma paziņojuma neievērošanas rezultātā var rasties kaitējums īpašumam.

Tabula 1: Bīstamības līmeņi



### 1.2.2 Bīstamības simboli

Bīstamības simboli ir simboliski apzīmējumi, kas sniedz norādes par bīstamības veidu.

Šajā dokumentā ir izmantoti šādi bīstamības simboli:

Bīstamības simbols	Nozīme
	Vispārējs brīdinājuma paziņojums
	Elektriskā sprieguma radīts apdraudējums
	Sprādzienbīstamības risks
	Griezumu bīstamība
	Saspiešanas bīstamība

## **i** Par šo dokumentu

Bīstamības simbols	Nozīme
	Karstu virsmu radīta bīstamība
	Spēcīgu magnētisko lauku radīta bīstamība
	Nejonizējoša starojuma radīta bīstamība

Tabula 2: Bīstamības simboli

### 1.2.3 Brīdinājumu struktūra

Šajā dokumentā sniegtajiem brīdinājumiem ir standartizēts noformējums un standartizēta struktūra.



	<p><b>⚠ BĪSTAMI</b></p> <p><b>Bīstamības veids un avots!</b> Iespējamās sekas, kas rodas, neievērojot bīstamības paziņojumu / brīdinājumu.</p> <ul style="list-style-type: none"> <li>▶ Bīstamības novēršanas pasākumi un aizliegumi.</li> </ul>
--	--





Nākamajā piemērā ir parādīts brīdinājums, kas apzīmē elektrotrieciena risku, ko rada spriegumaktīvas detaļas. Ir norādīts bīstamības novēršanas pasākums.

	<p><b>⚠ BĪSTAMI</b></p> <p><b>Elektrotrieciena risks, ko rada spriegumaktīvas detaļas!</b> Nāvējošs elektrotrieciens</p> <ul style="list-style-type: none"> <li>▶ Atvienojiet iekārtas no strāvas padeves vismaz 60 sekundes pirms labošanas sākšanas.</li> </ul>
--	---

### 1.2.4 Vispārīgie simboli

Šajā dokumentā ir izmantoti šādi vispārīgie simboli:

Visp. simbols	Nozīme
	Īpašu ieteikumu apzīmējums (teksts un/ vai grafika)
	Vienkāršu ieteikumu apzīmējums (tikai teksts)

Visp. simbols	Nozīme
	Video pamācības saites apzīmējums
	Nepieciešamo rīku apzīmējums
	Nepieciešamo priekšnosacījumu apzīmējums
	Nosacījuma apzīmējums (ja ..., tad ...)
	Rezultāta apzīmējums
[Sākt]	Taustiņa vai pogas apzīmējums
[00123456]	Materiāla numura apzīmējums
Statuss	Attēlotā teksta / loga apzīmējums (iekārtas displejā)

Tabula 3: Vispārīgie simboli

## 2.1 Vispārējie drošības norādījumi

### 2.1.1 Visām mājsaimniecības ierīcēm

#### **Elektrotrieciena risks spriegumaktīvu daļu dēļ!**

- Ja remonts, kas skar elektriskās daļas, ir veikts kļūdaini, pastāv elektrotrieciena risks!
- Ierīcei ir jābūt atvienotai no tīkla vismaz 60 sekundes, pirms sāk darbu.
- Pēc remonta ierīces drošība ir jāpārbauda atbilstīgi noteikumiem VDE 0701 vai valsts noteikumiem.

#### **Savainojumu risks asu malu dēļ!**

- Valkājiet aizsargcimdus.

#### **Saspiešanas risks labošanas, uzturēšanas, traucējumu novēršanas un apkopes laikā, ko rada smagas un kustīgas detaļas**

- Valkājiet aizsargapavus.
- Nostipriniet smagas detaļas, lai tās nenokristu.
- Neievietojiet ķermeņa daļas kustīgās detaļās.



#### **Ierīces drošības / darbības traucējuma risks!**

- Izmantojiet tikai oriģinālās rezerves daļas.

#### **Pret elektrostatisko izlādi jutīgu daļu (ESDS) bojājuma risks!**

- Neaiztieciet moduļus, ieskaitot savienojumus un vadojumu.

## Piederumi un palīglīdzekļi

Apzīmējums	Sīkāka informācija	Attēli
Aizsargdrāna [00342013]	60 cm x 50 cm	
Torx uzgalis TX20 [00340865]	6,3 mm (1/4")	
Īpašs darbarīks [00342180]		

## 4.1 Durvju blīvslēga nomaīņa

### Prasība:

- ✓ Durvīm ir jābūt atvērtām.

### 4.1.1 Durvju blīvslēga noņemšana

1. Atbrīvojiet durvju blīvslēgu no rievas labajā un kreisajā pusē.

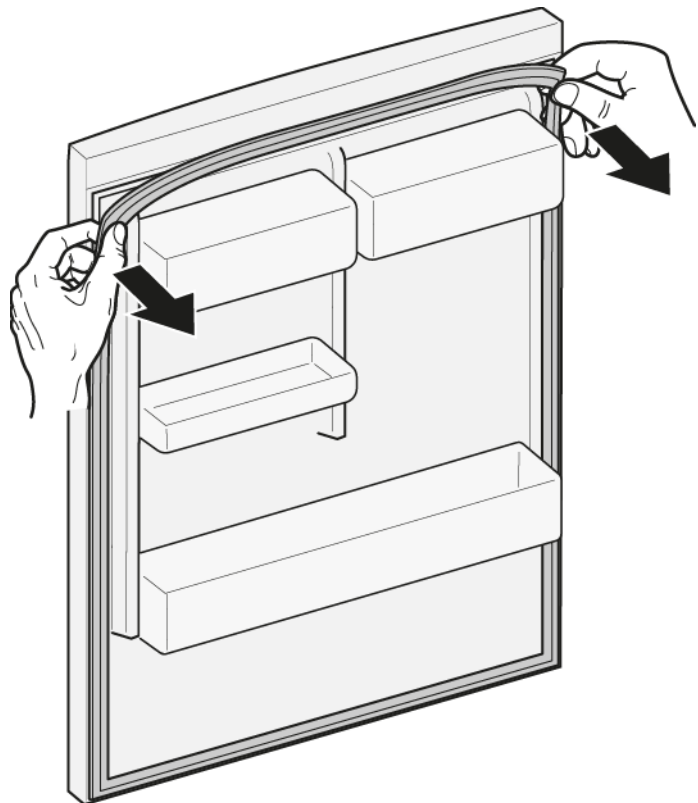

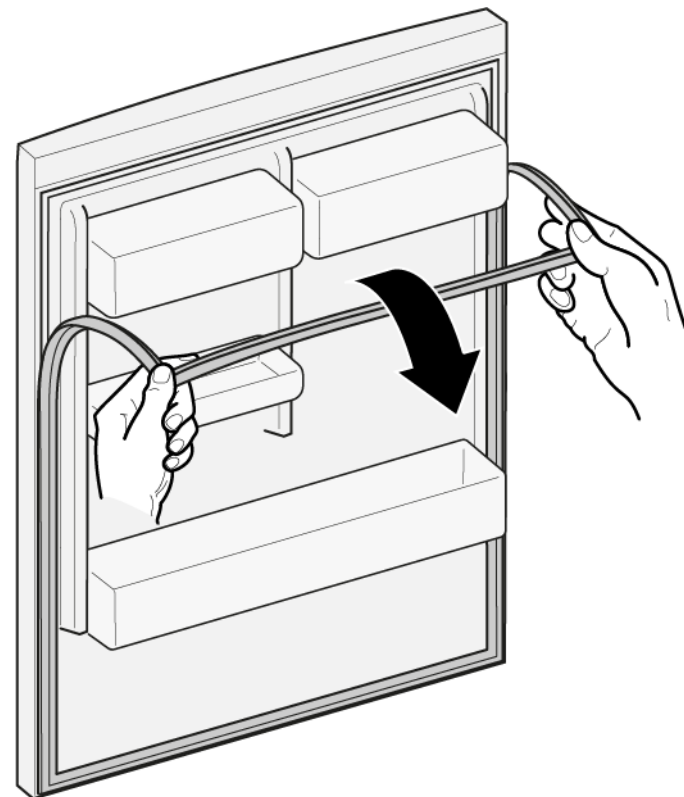

2. Izvelciet durvju blīvslēgu no rievas.



- ➡ Durvju blīvslēgs ir noņemts.

### 4.1.2 Durvju blīvslēga uzstādīšana

	Jaunā durvju blīvslēga biezums var mazliet atšķirties no vecā durvju blīvslēga biezuma. Tas neietekmē aizvēršanos un darbību ilgtermiņā.
	Ja ierīces viras var regulēt vai tai ir viru savienojumi, vēlāk aizvēršanos var pielāgot.
	Mazie caurumi durvju blīvslēga sānos ir funkcionāli (nodrošina ventilāciju). Tie nav ražošanas defekti.

1. Pārbaudiet, ka blīvslēga rieta nav bojāta.

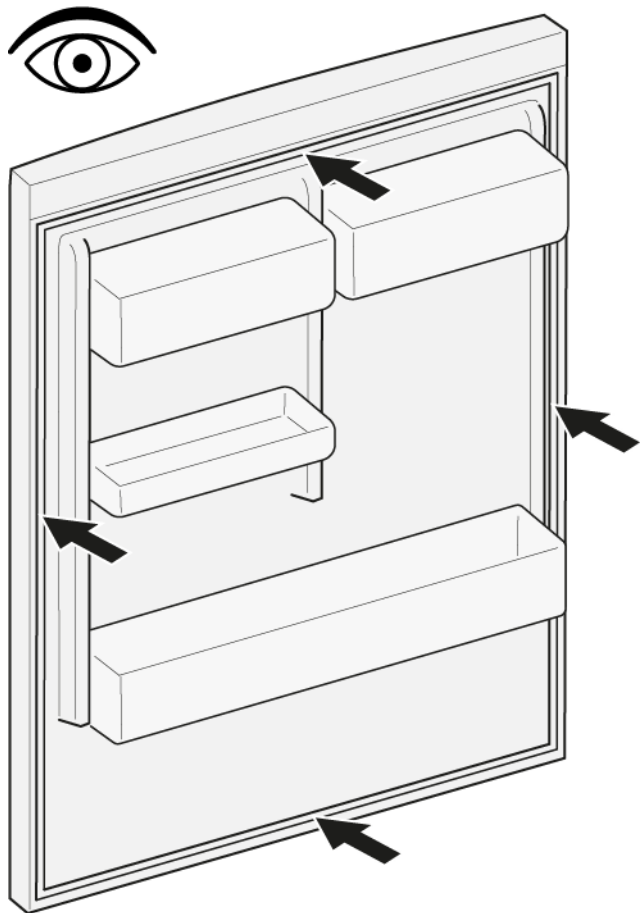

4. Iespiediet blīvslēga augšējos un apakšējos stūrus rieta.

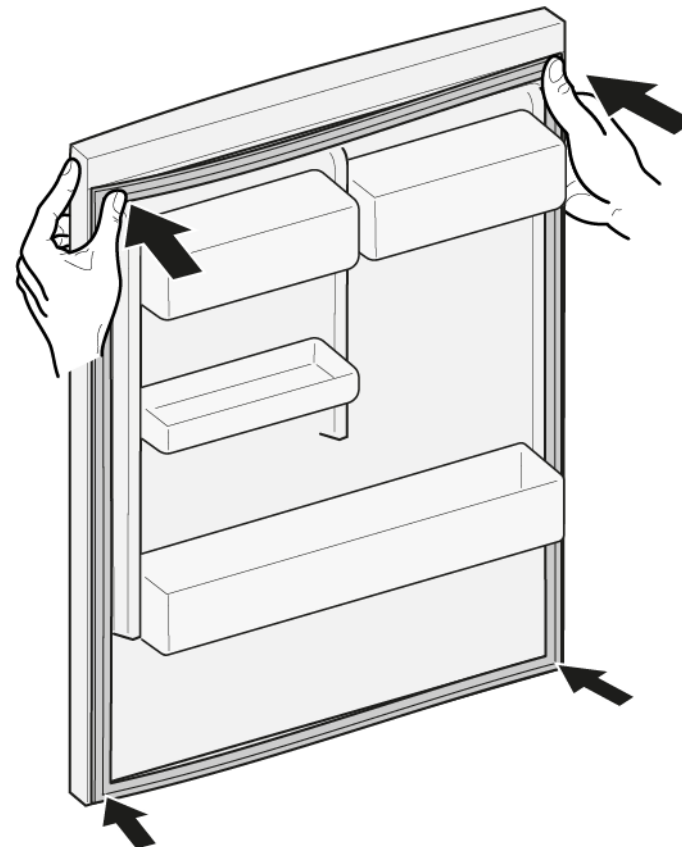

2.  Ja blīvslēga rieta ir bojāta  
- Sazinieties ar klientu apkalpošanas dienesta pārstāvi.

3.  Durvju blīvslēgs var būt mazliet deformējies, kas neietekmē tā darbību. Pirms durvju blīvslēgu ieliek ierīcē, to ir ieteicams iztaisnot.

Sasildiet durvju blīvslēgu ar matu fēnu vai karstā ūdenī un ar rokām atjaunojiet tā formu.



5. Pakāpeniski iespiediet visu blīvslēgu rievā.

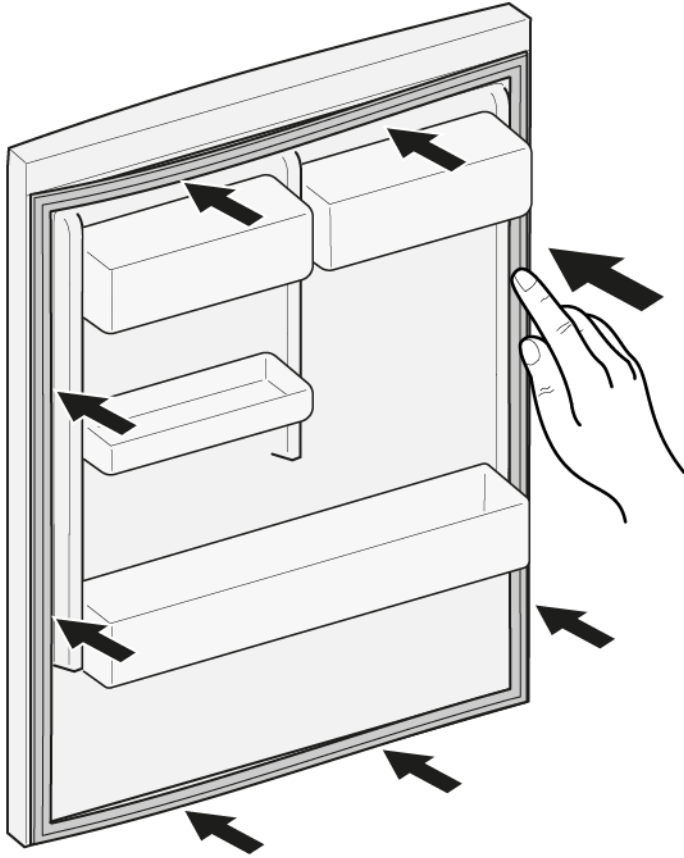

 Durvju blīvslēgs ir uzstādīts.

## 4.2 Plakanās viras nomaiņa

### Speciāli rīki:

Torx uzgalis TX20

6,3 mm (1/4")

[00340865]

	<b>BRĪDINĀJUMS</b>
	<p><b>Smaga lielizmēra ierīce!</b> Muguras un muskuļu savainojumi</p> <ul style="list-style-type: none"> <li>▶ Ierīces durvis drīkst noņemt tikai apmācīts speciālists.</li> <li>▶ Ierīce ir jāpārvieta divatā.</li> <li>▶ Ir jāizmanto tikai piemēroti darbarīki un aprīkojums.</li> </ul>

	<b>ESIET PIESARDZĪGI</b>
	<p><b>Asas malas!</b> Grieztas brūces</p> <ul style="list-style-type: none"> <li>▶ Lietojiet aizsargcimdus.</li> </ul>

	<b>ESIET PIESARDZĪGI</b>
	<p><b>Atveriet eņģu nodalījumu!</b> Pirkstu saspiešana / iesprūšana</p> <ul style="list-style-type: none"> <li>▶ Neievietojiet rokas eņģu nodalījumā.</li> <li>▶ Valkājiet aizsargcimdus.</li> </ul>

	<b>ESIET PIESARDZĪGI</b>
	<p><b>Krītošu detaļu risks, ko izraisa vaļīgas skrūves!</b> Krītošu detaļu izraisītas traumas.</p> <ul style="list-style-type: none"> <li>▶ Nostipriniet detaļu, lai tā nenokristu.</li> </ul>

	<b>UZMANĪBU!</b>
	<p><b>Krītošu detaļu risks, ko izraisa vaļīgas skrūves!</b> Citu ierīces detaļu bojājumi vai bojājumi, kas rodas klienta mājās, piem., apakšpuse.</p> <ul style="list-style-type: none"> <li>▶ Nostipriniet detaļu, lai tā nenokristu.</li> </ul>

### Prasība:

- ✔ Ierīces elektropadevei ir jābūt atvienotai.
- ✔ Mēbeles durvīm ir jābūt noņemtām. Skatiet uzstādīšanas instrukciju.
- ✔ Durvīm ir jābūt atvērtām.

## 4.2.1 Plakanās viras noņemšana

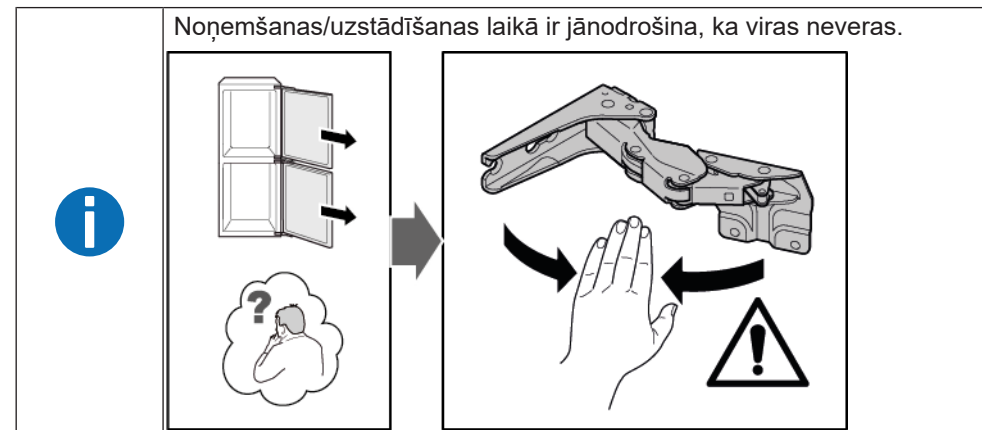

1. Noņemiet četrus viras pārsegus.

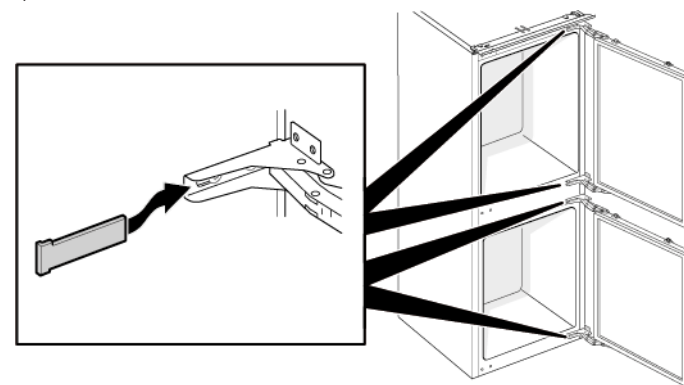

## Remonts

2. 1. Atskrūvējiet četras skrūves (1).  
2. Augšējās durvis izvelciet un noņemiet (2).

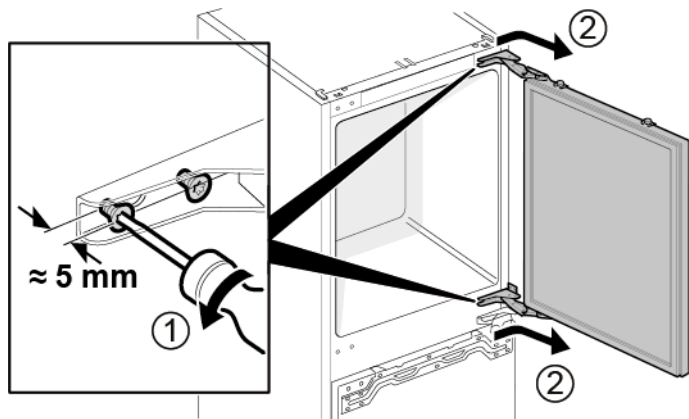

3. 1. Izskrūvējiet četras skrūves (1).  
2. Noņemiet viras (2).

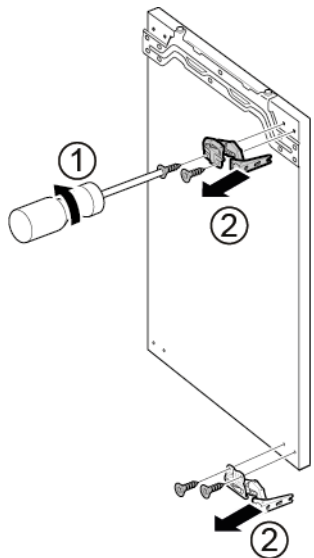

➡ Augšējo durvju viras ir noņemtas.

4. 1. Atskrūvējiet četras skrūves (1).  
2. Apakšējās durvis izvelciet un noņemiet (2).

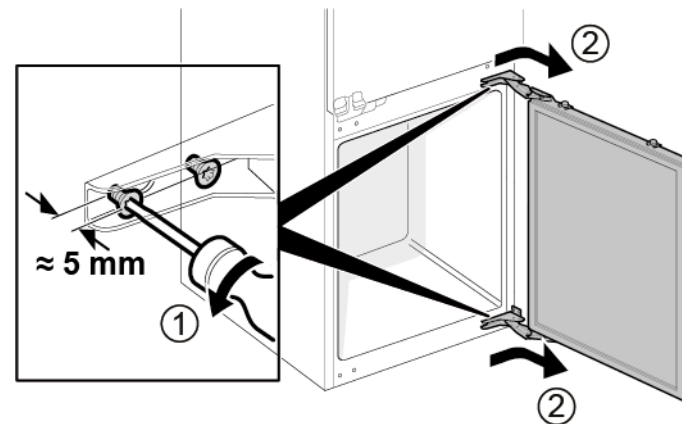

5. 1. Izskrūvējiet četras skrūves (1).  
2. Noņemiet viras (2).

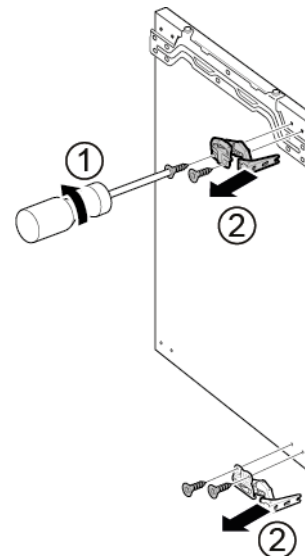

➡ Apakšējo durvju viras ir noņemtas.





### 4.2.2 Plakanās viras uzstādīšana

- ▶ Uzstādiet apgrieztā kārtībā.

## 4.3 Slīdošās viras nomaiņa

### Speciāli rīki:

Torx uzgalis TX20 6,3 mm (1/4") [00340865]

	<p><b>BRĪDINĀJUMS</b></p> <p><b>Smaga lielizmēra ierīce!</b> Muguras un muskuļu savainojumi</p> <ul style="list-style-type: none"> <li>▶ Ierīces durvis drīkst noņemt tikai apmācīts speciālists.</li> <li>▶ Ierīce ir jāpārvieta divatā.</li> <li>▶ Ir jāizmanto tikai piemēroti darbarīki un aprīkojums.</li> </ul>
	<p><b>ESIET PIESARDZĪGI</b></p> <p><b>Asas malas!</b> Grieztas brūces</p> <ul style="list-style-type: none"> <li>▶ Lietojiet aizsargcimdus.</li> </ul>
	<p><b>ESIET PIESARDZĪGI</b></p> <p><b>Krītošu detaļu risks, ko izraisa vaļīgās skrūves!</b> Krītošu detaļu izraisītas traumas.</p> <ul style="list-style-type: none"> <li>▶ Nostipriniet detaļu, lai tā nenokristu.</li> </ul>
	<p><b>UZMANĪBU!</b></p> <p><b>Krītošu detaļu risks, ko izraisa vaļīgās skrūves!</b> Citu ierīces detaļu bojājumi vai bojājumi, kas rodas klienta mājās, piem., apakšpuse.</p> <ul style="list-style-type: none"> <li>▶ Nostipriniet detaļu, lai tā nenokristu.</li> </ul>

### Prasība:

- ✓ Ierīces elektropadevei ir jābūt atvienotai.
- ✓ Mēbeles durvis un ierīces durvis ir atvienotas. Skatiet uzstādīšanas instrukciju.

## 4.3.1 Slīdošās viras noņemšana

1. Izskrūvējiet abas skrūves (1).
2. Noņemiet augšējo durvju augšējo viru (2).
3. Noņemiet augšējās durvis (3).
4. Izskrūvējiet abas skrūves (4).
5. Noņemiet apakšējo durvju augšējo viru (5).
6. Noņemiet apakšējās durvis (6).

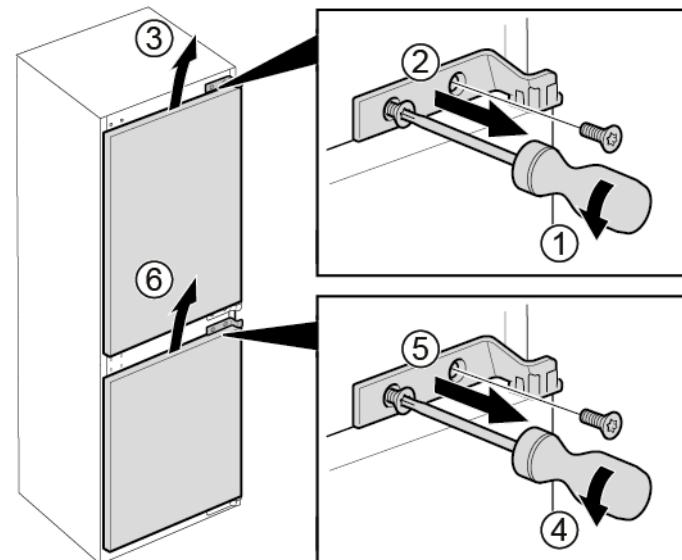

1. Izskrūvējiet četras skrūves (1).
2. Noņemiet apakšējās viras (2).

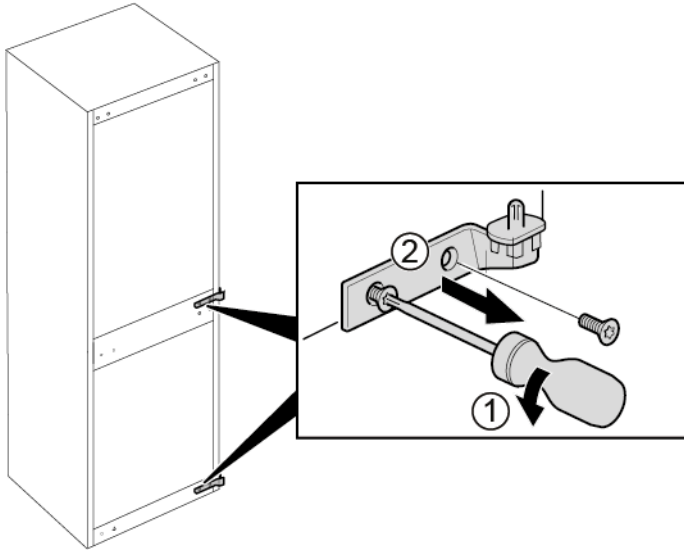

 Viras ir noņemtas.

### 4.3.2 Slidošās viras uzstādīšana

- ▶ Uzstādiet apgrieztā kārtībā.

## 4.4 Durvju plaukta nomaiņa

### Prasība:

- ✓ Durvīm ir jābūt atvērtām.

### 4.4.1 Durvju plaukta noņemšana

- ▶ Paceliet durvju plauktu uz augšu.

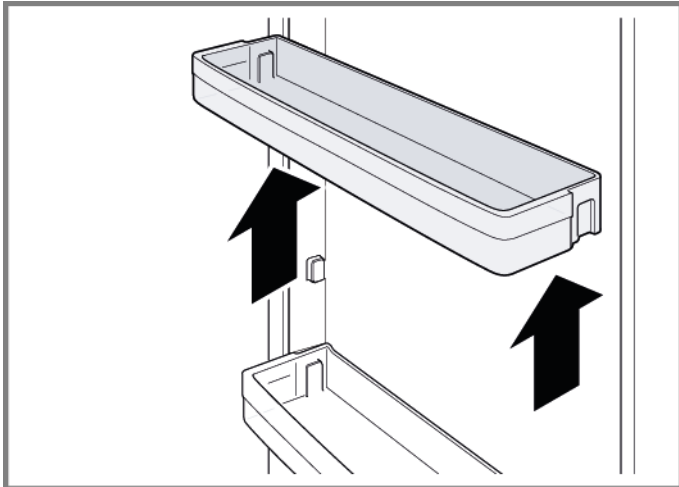

- ➡ Durvju plaukts ir noņemts.

### 4.4.2 Durvju plaukta uzstādīšana

- ▶ Uzstādiet apgrieztā kārtībā.

## 4.5 Plaukta nomaiņa

### Prasība:

- ✔ Durvīm ir jābūt atvērtām.

### 4.5.1 Plaukta izņemšana

- ▶ Izvelciet plauktu.

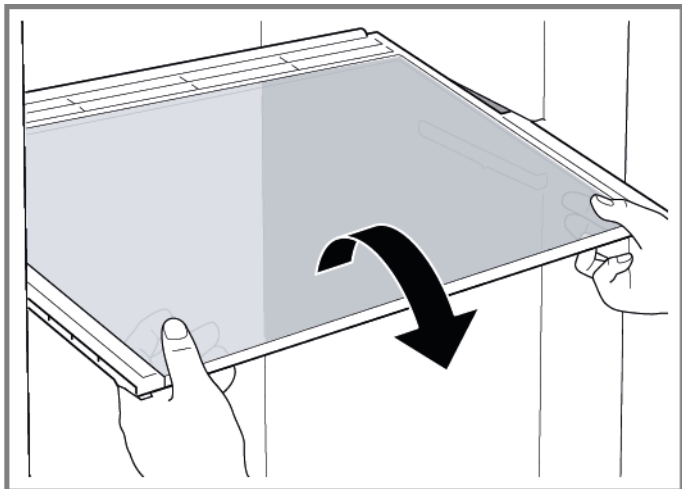

- ➡ Plaukts ir izņemts.

### 4.5.2 Plaukta uzstādīšana

- ▶ Uzstādiet apgrieztā kārtībā.



## 4.6 Izvelkamā plaukta nomaiņa

### Prasība:

- ✔ Durvīm ir jābūt atvērtām.

### 4.6.1 Izvelkamā plaukta izņemšana

1. Velciet izvelkamo plauktu uz āru, līdz aizturis atbrīvojas.

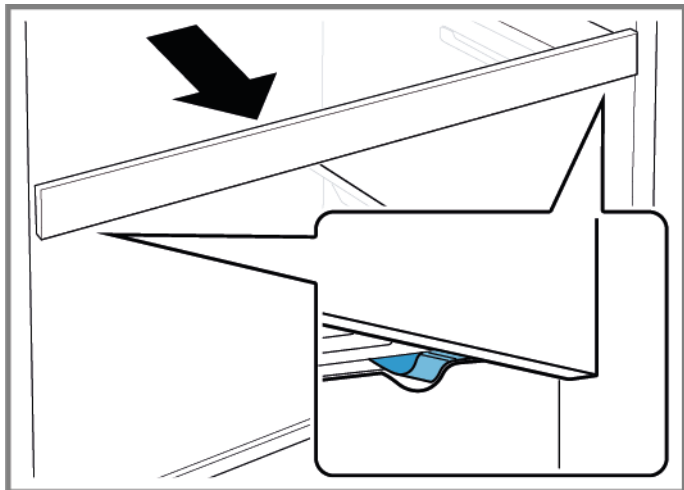

2. Izvelkamo plauktu nolaidiet un sasveriet uz sāniem, lai izņemtu.
3. ➡ Izvelkamais plaukts ir izņemts.

### 4.6.2 Izvelkamā plaukta uzstādīšana

- ▶ Uzstādiet apgrieztā kārtībā.

## 4.7 Saldētavas nodalījuma plaukta nomaiņa

### Prasība:

- ✔ Durvīm ir jābūt atvērtām.

### 4.7.1 Saldētavas nodalījuma plaukta izņemšana

- ▶ Izvelciet saldētavas nodalījuma plauktu.

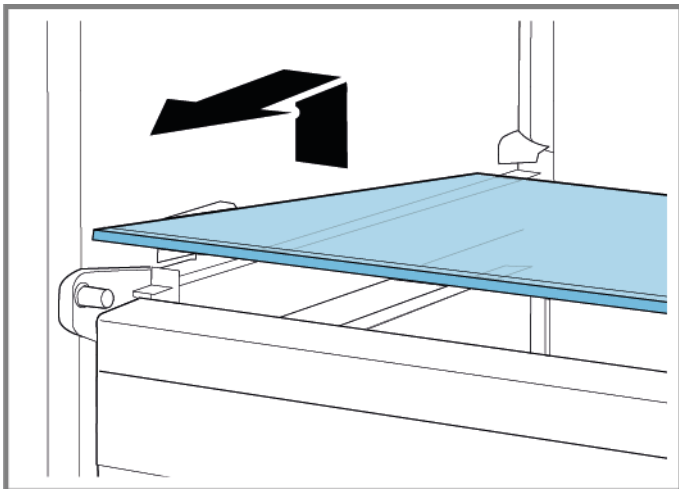

- ➡ Saldētavas nodalījuma plaukts ir izņemts.

### 4.7.2 Saldētavas nodalījuma plaukta uzstādīšana

- ▶ Uzstādiet apgrieztā kārtībā.

## 4.8 Saldētās pārtikas tvertnes nomaiņa

### Prasība:

- ✔ Durvīm ir jābūt atvērtām.

### 4.8.1 Saldētās pārtikas tvertnes izņemšana

- ▶ 1. Pilnībā izvelciet saldētās pārtikas tvertni (1).
- ▶ 2. Izņemiet saldētās pārtikas tvertni (2).

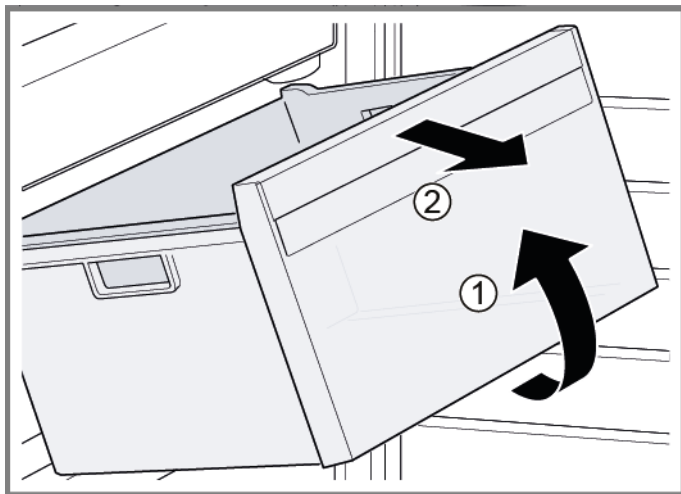

- ➡ Saldētās pārtikas tvertne ir izņemta.

### 4.8.2 Saldētās pārtikas tvertnes uzstādīšana

- ▶ Uzstādiet apgrieztā kārtībā.

## 4.9 Augļu un dārzeņu tvertnes nomaiņa

### Prasība:

- ✔ Durvīm ir jābūt atvērtām.

### 4.9.1 Augļu un dārzeņu tvertnes izņemšana

- ▶ 1. Pilnībā izvelciet tvertni (1).
- ▶ 2. Izņemiet tvertni (2).

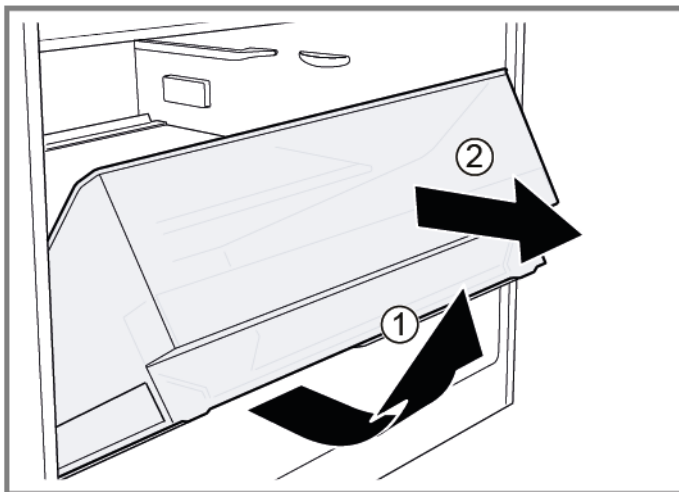

- ➡ Tvertne ir izņemta.

### 4.9.2 Augļu un dārzeņu tvertnes uzstādīšana

- ▶ Uzstādiet apgrieztā kārtībā.

## 4.10 Starplikas un augļu un dārzeņu tvertnes vāka nomaiņa

### Prasība:

- ✔ Durvīm ir jābūt atvērtām.

### 4.10.1 Starplikas izņemšana un augļu un dārzeņu tvertnes vāka noņemšana

1. Izņemiet no starplikas stikla plāksni.

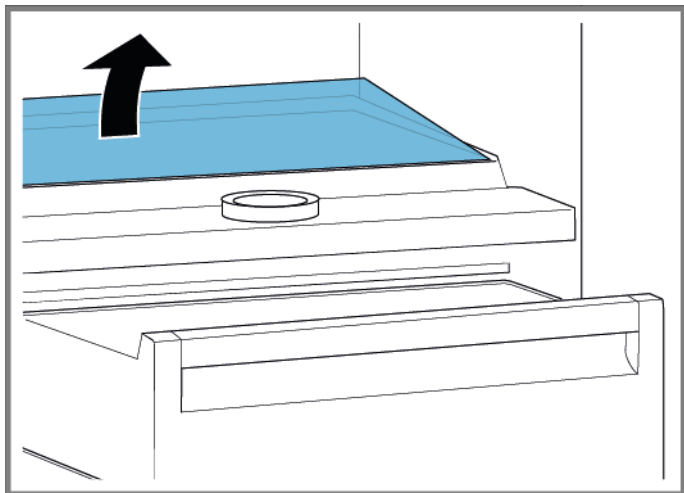

2. [Izņemiet augļu un dārzeņu tvertni.→332](#)

3. 1. Nospiediet sviru starplikas apakšā abās pusēs (1).
2. Velciet starpliku uz priekšu (2).

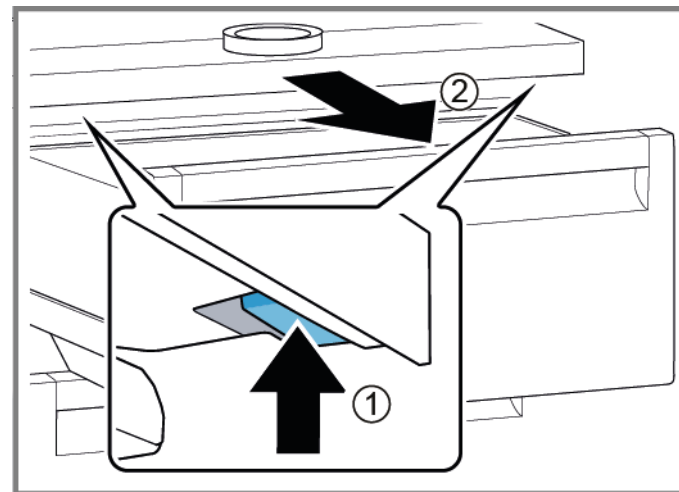

4. Starpliku paceliet un sagāziet uz sāniem, lai izņemtu.  
➡ Starplika ir izņemta.
5. 1. Paceliet augļu un dārzeņu tvertnes vāku.  
2. Augļu un dārzeņu tvertnes vāku pavelciet uz priekšu un sagāziet uz sāniem, lai izņemtu.  
➡ Augļu un dārzeņu tvertnes vāks ir noņemts.

### 4.10.2 Starplikas un augļu un dārzeņu tvertnes vāka uzstādīšana

- ▶ Uzstādiet apgrieztā kārtībā.

## 4.11 Svaiguma saglabāšanas tvertnes nomaiņa

### Prasība:

- ✔ Durvīm ir jābūt atvērtām.

### 4.11.1 Svaiguma saglabāšanas tvertnes izņemšana

- ▶ 1. Sagāziet svaiguma saglabāšanas tvertni uz priekšu (1).
- ▶ 2. Izņemiet svaiguma saglabāšanas tvertni (2).

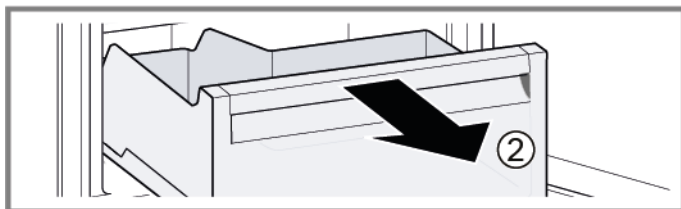
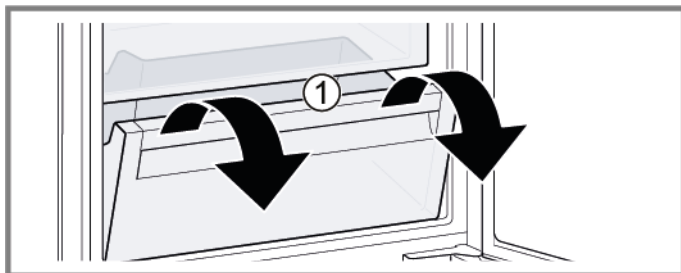

- ➡ Svaiguma saglabāšanas tvertne ir izņemta.

### 4.11.2 Svaiguma saglabāšanas tvertnes uzstādīšana

- ▶ Uzstādiet apgrieztā kārtībā.

## 4.12 Izvelkamās tvertnes nomaiņa

### Prasība:

- ✔ Durvīm ir jābūt atvērtām.

### 4.12.1 Izvelkamās tvertnes izņemšana

- ▶ 1. Sagāziet izvelkamo tvertni uz priekšu (1).
- ▶ 2. Izņemiet izvelkamo tvertni (2).

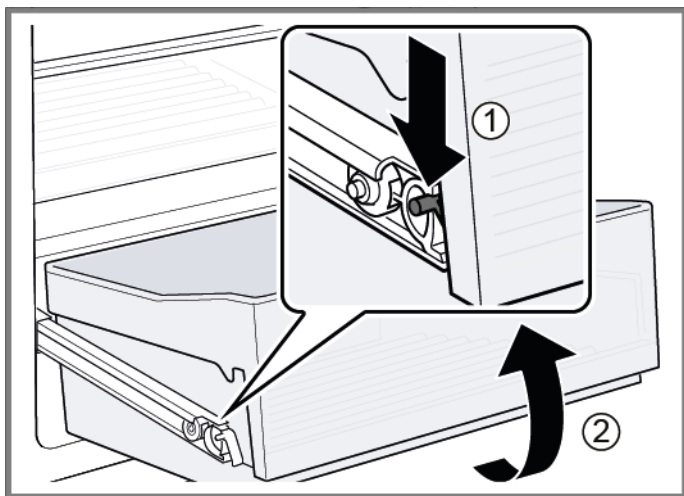

- ➡ Izvelkamā tvertne ir izņemta.

### 4.12.2 Izvelkamās tvertnes uzstādīšana

- ▶ Uzstādiet apgrieztā kārtībā.

## 4.13 LED starmeša nomaiņa

### Speciāli rīki:

- 🔧 Īpašs darbarīks [00342180]
- 🔧 Plakanais skrūvgriezis Izmērs: 2,4 mm x 0,4 mm x 60 mm, komplektā [00341820]

**i** Ierīcē ir LED gaismeklis, kam nav jāveic apkope. Šo gaismekli drīkst remontēt tikai klientu apkalpošanas dienesta pārstāvis vai pilnvarots tehniķis!

**⚠ BĪSTAMI**  
**Elektrotrieciena risks spriegumaktīvu daļu dēļ!**  
 Dzīvības apdraudējums nepareiza remonta izraisīta elektrotrieciena dēļ

- ▶ Elektriskās daļas ir jāremontē kvalificētam elektriķim.
- ▶ Pēc remonta ierīces drošība ir jāpārbauda atbilstīgi noteikumiem VDE 0701 vai valsts noteikumiem.

**⚠ BĪSTAMI**  
**Elektrotrieciena risks, ko rada spriegumaktīvas detaļas!**  
 Nāvējošs elektrotrieciens

- ▶ Atvienojiet iekārtas no strāvas padeves vismaz 60 sekundes pirms labošanas sākšanas.

**⚠ ESIET PIESARDZĪGI**  
**Asas malas!**  
 Grieztas brūces

- ▶ Lietojiet aizsargcimdus.

### Prasība:

- ✅ Ierīces elektropadevei ir jābūt atvienotai.
- ✅ Durvīm ir jābūt atvērtām.
- ✅ Ledusskapja nodalījuma plauktiem ir jābūt izņemtiem.

## 4.13.1 LED starmeša noņemšana

1. Atbrīvojiet LED starmeša pārsegu.

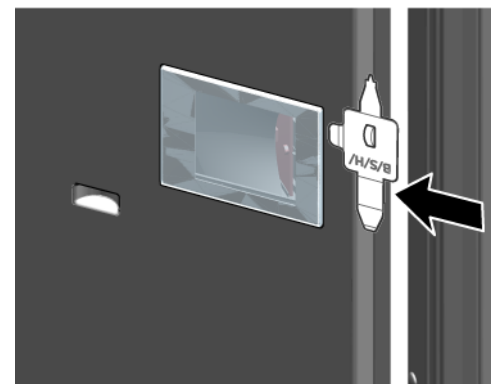

2. LED starmeša pārsegu vienlaikus velciet uz iekšu un prom no sienas.

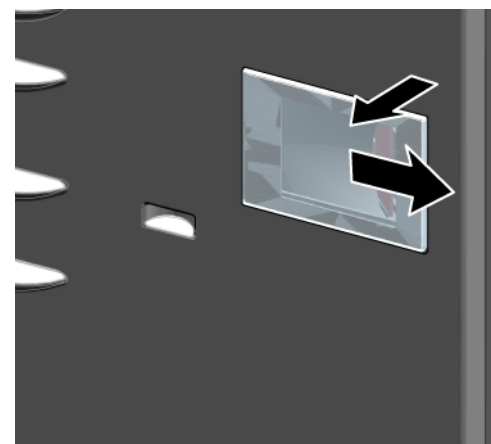



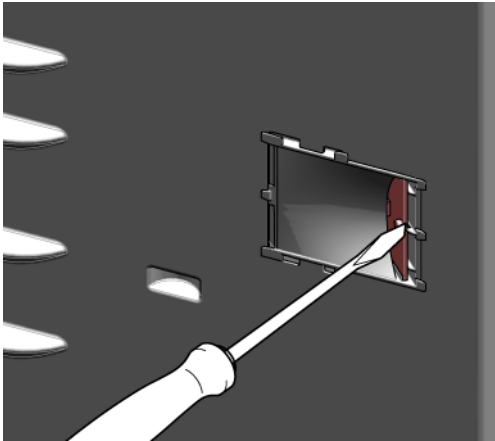

3. Atvienojiet LED starmeša moduli.

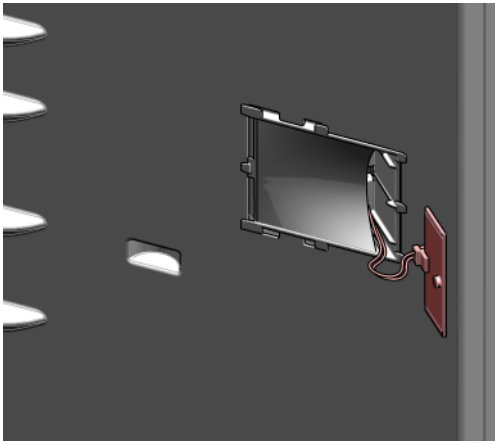

4. Atvienojiet LED starmeša elektrisko savienojumu.







 LED starmetis ir noņemts.

### 4.13.2 LED starmeša uzstādīšana

▶ Uzstādiet apgrieztā kārtībā.

# Informacija apie remontą - Šaldymo prietaiso ir šaldiklio kombinacija

 <b>Dėl šio dokumento</b> .....	<b>339</b>	4.8 Šaldytų maisto produktų talpyklos keitimas .....	355
1.1 Svarbi informacija .....	339	4.8.1 Šaldytų maisto produktų talpyklos išėmimas .....	355
1.1.1 Paskirtis .....	339	4.8.2 Šaldytų maisto produktų talpyklos įdėjimas .....	355
1.2 Simbolių paaiškinimas .....	339	4.9 Vaisių ir daržovių talpyklos keitimas .....	356
1.2.1 Pavojaus lygiai .....	339	4.9.1 Vaisių ir daržovių talpyklos išėmimas .....	356
1.2.2 Pavojaus simboliai .....	339	4.9.2 Vaisių ir daržovių talpyklos įdėjimas .....	356
1.2.3 Įspėjimų struktūra .....	340	4.10 Vaisių ir daržovių talpyklos pertvaros ir dangčio keitimas .....	357
1.2.4 Bendrieji simboliai .....	340	4.10.1 Vaisių ir daržovių talpyklos pertvaros išėmimas ir dangčio nuėmimas .....	357
 <b>Sauga</b> .....	<b>341</b>	4.10.2 Vaisių ir daržovių talpyklos pertvaros įdėjimas ir dangčio uždėjimas ...	357
2.1 Bendrosios saugos instrukcijos.....	341	4.11 Atšaldytų šviežių produktų talpyklos keitimas .....	358
2.1.1 Visi buitiniai prietaisai .....	341	4.11.1 Atšaldytų šviežių produktų talpyklos išėmimas.....	358
 <b>Įrankiai ir pagalbinės priemonės</b> .....	<b>342</b>	4.11.2 Atšaldytų šviežių produktų talpyklos įdėjimas .....	358
 <b>Remontas</b> .....	<b>343</b>	4.12 Ištraukiamos talpyklos keitimas .....	359
4.1 Durelių tarpiklio keitimas .....	343	4.12.1 Ištraukiamos talpyklos išėmimas .....	359
4.1.1 Durelių tarpiklio išėmimas.....	343	4.12.2 Ištraukiamos talpyklos įdėjimas .....	359
4.1.2 Durelių tarpiklio įdėjimas.....	343	4.13 LED apšvietimo lempučių keitimas .....	360
4.2 Atlenkiamo vyro keitimas.....	346	4.13.1 LED apšvietimo lempučių išėmimas .....	360
4.2.1 Atlenkiamo vyro nuėmimas .....	346	4.13.2 LED apšvietimo lempučių montavimas.....	361
4.2.2 Atlenkiamo vyro montavimas .....	348		
4.3 Slankiojo vyro keitimas.....	349		
4.3.1 Slankiojo vyro nuėmimas .....	349		
4.3.2 Slankiojo vyro montavimas .....	350		
4.4 Durelių lentynos keitimas .....	351		
4.4.1 Durelių lentynos išėmimas.....	351		
4.4.2 Durelių lentynos įdėjimas.....	351		
4.5 Lentynos keitimas.....	352		
4.5.1 Lentynos nuėmimas .....	352		
4.5.2 Lentynos įdėjimas .....	352		
4.6 Ištraukiamos lentynos keitimas .....	353		
4.6.1 Ištraukiamos lentynos išėmimas.....	353		
4.6.2 Ištraukiamos lentynos įdėjimas .....	353		
4.7 Šaldiklio skyriaus lentynos keitimas .....	354		
4.7.1 Šaldiklio skyriaus lentynos išėmimas.....	354		
4.7.2 Šaldiklio skyriaus lentynos įdėjimas.....	354		

# **i** Dėl šio dokumento

## 1.1 Svarbi informacija

### 1.1.1 Paskirtis

Šios remonto nuorodos padeda naudotojui pataisyti prietaisus patiems pagal galiojantį ekologinio projektavimo reglamentą (2021 m. kovo mėn. redakcija).

Jose pateikta informacija, kaip pakeisti tam tikras atsargines dalis, įskaitant ir įspėjimus bei riziką.

Jei kiltų klausimų, kreipkitės į mūsų klientų aptarnavimo tarnybą. Mes atsakysime už žalą tik tuo atveju, jei bus tinkamai laikomasi remonto nuorodų.

## 1.2 Simbolių paaiškinimas

### 1.2.1 Pavojaus lygiai

Įspėjimo lygiai susideda iš simbolio ir signalinio žodžio. Signalinis žodis nurodo pavojaus sunkumą.





Įspėjimo lygis	Reikšmė
 <b>PAVOJUS</b>	Nepaisant įspėjamojo pranešimo, ištinka mirtis arba sunkūs sužalojimai.
 <b>ĮSPĖJIMAS</b>	Nepaisant įspėjamojo pranešimo, gali ištikti mirtis arba sunkūs sužalojimai.
 <b>PERSPĖJIMAS</b>	Nepaisant įspėjamojo pranešimo, galimi nedideli sužalojimai.
<b>DĖMESIO!</b>	Nepaisant įspėjamojo pranešimo, gali būti sugadintas turtas.

Lentelė 1: Pavojaus lygiai



### 1.2.2 Pavojaus simboliai

Pavojaus simboliai yra simboliniai atvaizdai, nurodantys pavojaus rūšį.

Šiame: dokumente naudojami tokie pavojaus simboliai

Pavojaus simbolis	Reikšmė
	Bendras įspėjamasis pranešimas
	Pavojinga elektros įtampa
	Sprogimo pavojus
	Įpjovimo pavojus
	Prispaudimo pavojus

## **i** Dėl šio dokumento

Pavojaus simbolis	Reikšmė
	Pavojus dėl karštų paviršių
	Pavojus dėl stipraus magnetinio lauko
	Pavojus dėl nejonizuojančiosios spinduliuotės

Lentelė 2: Pavojaus simboliai

### 1.2.3 Įspėjimų struktūra

Šiame dokumente pateikiami įspėjimai yra standartizuotos išvaizdos ir standartizuotos struktūros.



	<p><b>⚠ PAVOJUS</b></p> <p><b>Pavojaus tipas ir šaltinis!</b> Galimos pasekmės, jei nepaisoma pavojaus / įspėjimo.</p> <ul style="list-style-type: none"> <li>▶ Priemonės ir draudimai pavojui išvengti.</li> </ul>
--	---





Šiame pavyzdyje parodytas įspėjimas, įspėjantis apie elektros smūgį dėl dalių su įtampa. Paminėta priemonė, kaip išvengti pavojaus.

	<p><b>⚠ PAVOJUS</b></p> <p><b>Elektros smūgio pavojus dėl dalių, kuriose yra įtampa!</b> Mirtis dėl elektros smūgio</p> <ul style="list-style-type: none"> <li>▶ Prieš pradėdami remontą, ne mažiau kaip prieš 60 sekundžių atjunkite prietaisus nuo elektros tiekimo.</li> </ul>
---	---

### 1.2.4 Bendrieji simboliai

Šiame dokumente naudojami tokie bendrieji simboliai:

Bendr. simbolis	Reikšmė
	Žymi specialų patarimą (tekstas ir (arba) grafika)
	Žymi paprastą patarimą (tik tekstas)
	Žymi nuorodą į vaizdo pamoką

Bendr. simbolis	Reikšmė
	Žymi reikalingus įrankius
	Žymi reikalingas prielaidas
	Žymi sąlygą (jei ..., tai ...)
	Žymi rezultatą
<code>[Paleisti]</code>	Žymi klavišą arba ekrano mygtuką
<code>[00123456]</code>	Žymi dalies numerį
<code>Būsena</code>	Žymi rodomą tekstą / langą (prietaiso ekrane)

Lentelė 3: Bendrieji simboliai

## 2.1 Bendrosios saugos instrukcijos

### 2.1.1 Visi būtiniai prietaisai

#### **Elektros smūgio pavojus dėl dalių, kuriose yra įtampa!**

- Elektrinių konstrukcinių dalių remonto klaidos gali sukelti elektros smūgį!
- Prieš pradėdami dirbti, ne mažiau kaip prieš 60 sekundžių atjunkite prietaisą nuo maitinimo.
- Po remonto pasirūpinkite, kad būtų atliktas saugos bandymas pagal VDE 0701 arba šalyje galiojančius reglamentus.

#### **Pavojus susižeisti į aštrias briaunas!**

- Mūvėkite apsaugines pirštines.

#### **Prispaudimo rizika remonto, einamosios techninės priežiūros, sutrikimų šalinimo ir techninės priežiūros metu dėl sunkių ir judančių konstrukcinių dalių**

- Avėkite apsauginius batus.
- Apsaugokite sunkias konstrukcines dalis, kad jos nenukristų.
- Neartinkite kūno dalių prie judančių konstrukcinių dalių.



#### **Rizika prietaiso saugai / veikimui!**

- Naudokite tik originalias atsargines dalis.

#### **Elektrostatškai jautrių konstrukcinių dalių (ESD) pažeidimo rizika!**

- Nelieskite modulių, o taip pat ir jų jungčių bei laidininkų kelių.

## Įrankiai ir pagalbinės priemonės

Paskyrimas	Išsami informacija	Vaizdai
Apsauginis audinys [00342013]	60 cm x 50 cm	
„Torx“ antgalis TX20 [00340865]	6,3 mm (1/4 col.)	
Specialus įrankis [00342180]		

## 4.1 Durelių tarpiklio keitimas

### Reikalavimas.

- ✔ Durelės turi būti atidarytos.

### 4.1.1 Durelių tarpiklio išėmimas

1. Išimkite durelių tarpiklį iš griovelio dešiniajame ir kairiajame kampe.

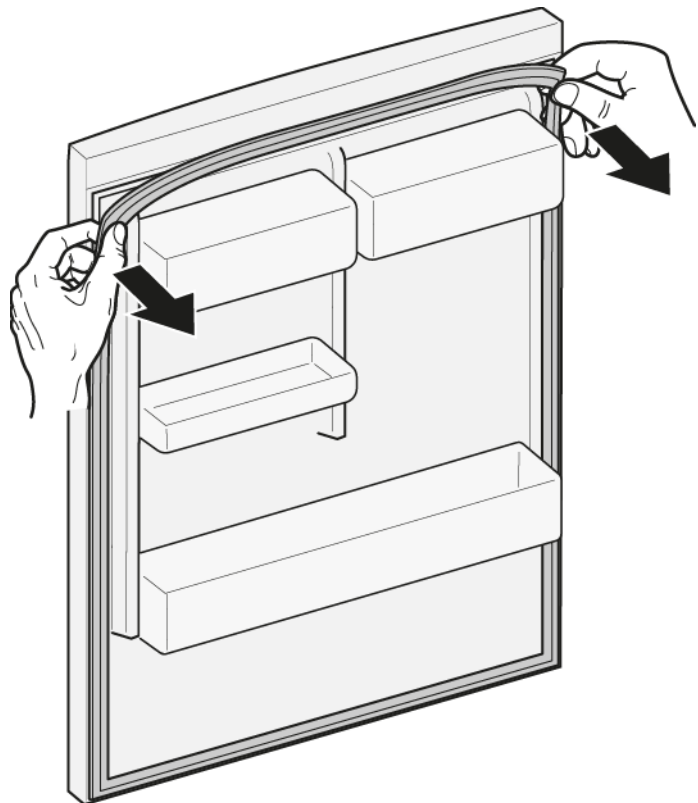

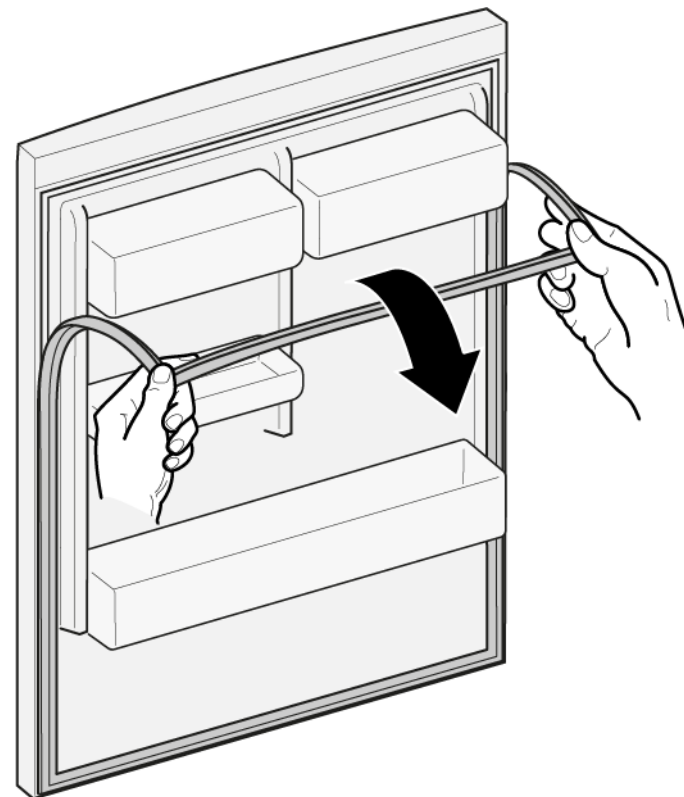

2. Ištraukite durelių tarpiklį iš griovelio.



- ➡ Durelių tarpiklis išimtas.

### 4.1.2 Durelių tarpiklio įdėjimas

	Naujo durelių tarpiklio storis gali šiek tiek skirtis nuo seno durelių tarpiklio storio. Dėl to durelės vis tiek užsidarys, o tarpiklį bus galima naudoti ilgai.
	Jei jūsų prietaiso vyriai arba vyrio priedai reguliuojami, uždarymo funkciją vėliau galima optimizuoti.
	Nedidelės šoninės skylutės durelių tarpiklyje turi savo funkciją (reikalingos ventiliacijai). Tai nėra gamybinis brokas.

1. Patikrinkite griovelį, ar nėra tarpiklių galinčių pažeisti vietų.

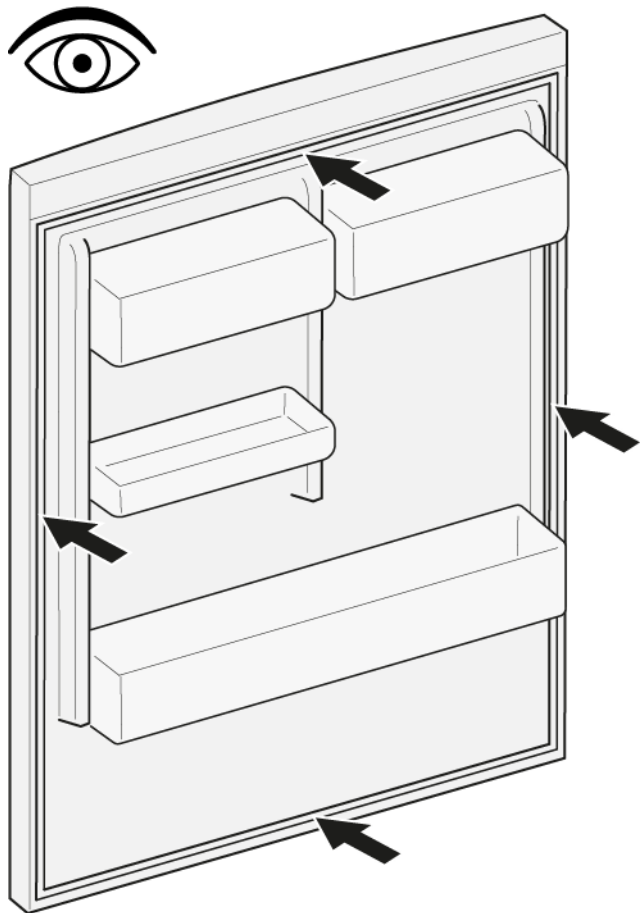

4. Įspauskite tarpiklio kampus viršuje ir apačioje į griovelį.

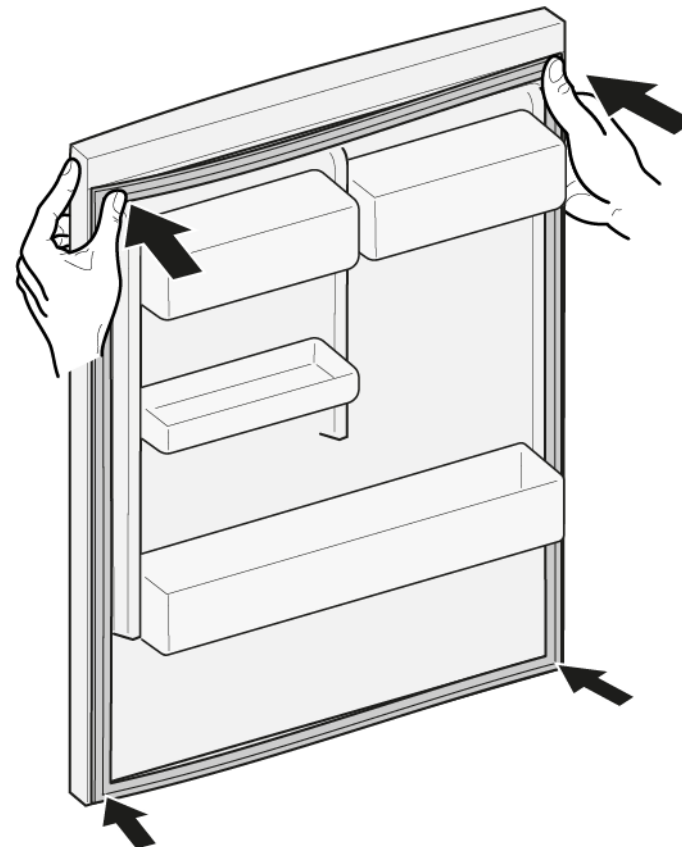

2.  Jei tarpiklio griovelis pažeistas.  
- Kreipkitės į klientų aptarnavimo tarnybą.

3.  Nedidelės durelių tarpiklio deformacijos yra įprastas požymis ir nepaveikia tarpiklio funkcinių savybių. Prieš įdedant durelių tarpiklį į prietaisą, rekomenduojama jį ištiesinti.

Pašildykite durelių tarpiklių plaukų džiovintuvu arba karštu vandeniu ir iš naujo suteikite formą rankiniu būdu.



5. Po truputį įspauskite į griovelį visą tarpiklį.

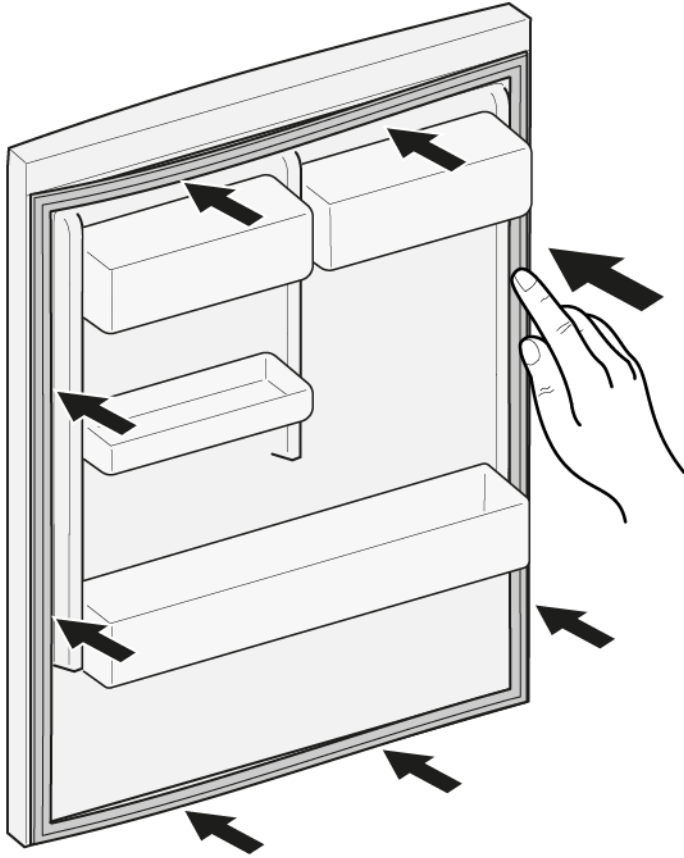

 Durelių tarpiklis įdėtas.

## 4.2 Atlenkiamo vyrio keitimas

### Specialūs įrankiai.

„Torx“ antgalis TX20

6,3 mm (1/4 col.)

[00340865]

	<b>⚠️ ĮSPĖJIMAS</b>
	<p><b>Sunkūs ir dideli prietaisai!</b> Nugaros ir raumenų sužalojimai</p> <ul style="list-style-type: none"> <li>▶ Prietaiso dureles nuimti gali tik apmokyti specialistai.</li> <li>▶ Norint perkelti prietaisą į kitą vietą, reikalingi du žmonės.</li> <li>▶ Naudokite tik tinkamus įrankius ir įrangą.</li> </ul>

	<b>⚠️ PERSPĖJIMAS</b>
	<p><b>Aštrios briaunos!</b> Galima įsipjauti</p> <ul style="list-style-type: none"> <li>▶ Mūvėkite apsaugines pirštines.</li> </ul>

	<b>⚠️ PERSPĖJIMAS</b>
	<p><b>Atvira vyrių sritis!</b> Galima prispausti / prisiverti pirštus</p> <ul style="list-style-type: none"> <li>▶ Nekiškite rankų į vyrių sritį.</li> <li>▶ Mūvėkite apsaugines pirštines.</li> </ul>

	<b>⚠️ PERSPĖJIMAS</b>
	<p><b>Pavojus, kad atpalaidavus varžtus dalys nukris!</b> Krentančios dalys gali sužeisti.</p> <ul style="list-style-type: none"> <li>▶ Apsaugokite konstrukcinę dalį, kad ji nenukristų.</li> </ul>

	<b>DĖMESIO!</b>
	<p><b>Pavojus, kad atpalaidavus varžtus dalys nukris!</b> Gali būti sugadintos kitos prietaiso dalys arba kliento namai, pvz., grindys.</p> <ul style="list-style-type: none"> <li>▶ Apsaugokite konstrukcinę dalį, kad ji nenukristų.</li> </ul>

### Reikalavimas.

- ✔️ Prietaisas turi būti atjungtas nuo maitinimo šaltinio.
- ✔️ Baldų durelės turi būti nuimtos. Žr. „Įrengimo instrukcija“.
- ✔️ Durelės turi būti atidarytos.

## 4.2.1 Atlenkiamo vyrio nuėmimas

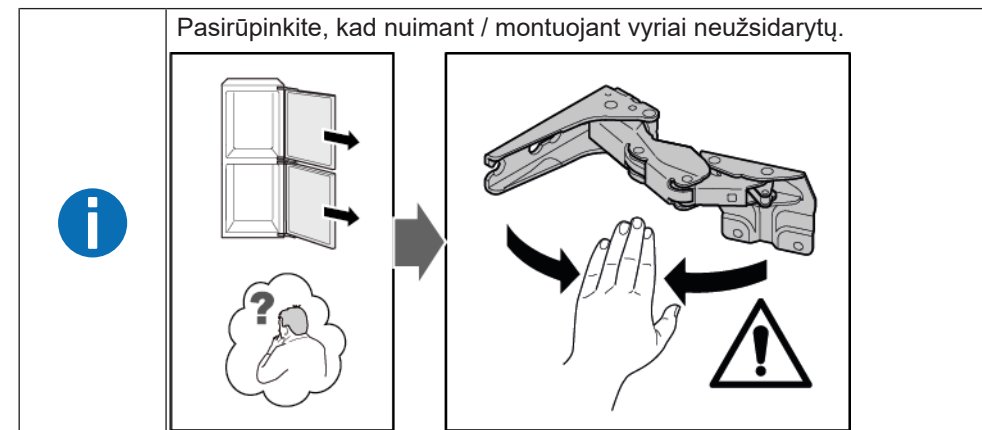

1. Nuimkite nuo keturių vyrių dangtelius.

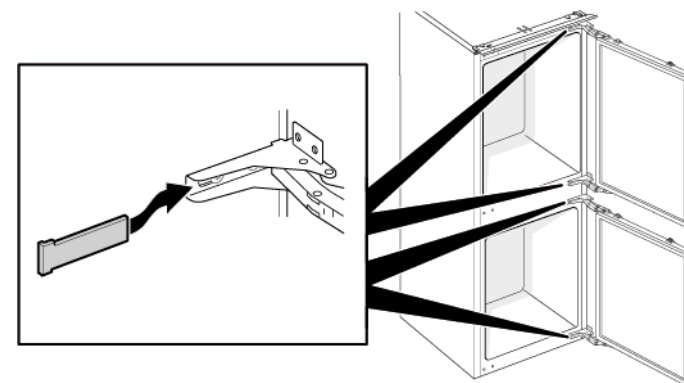

## Remontas

2. 1. Atleiskite keturis varžtus (1).  
2. Patraukite ir išimkite viršutines dureles (2).

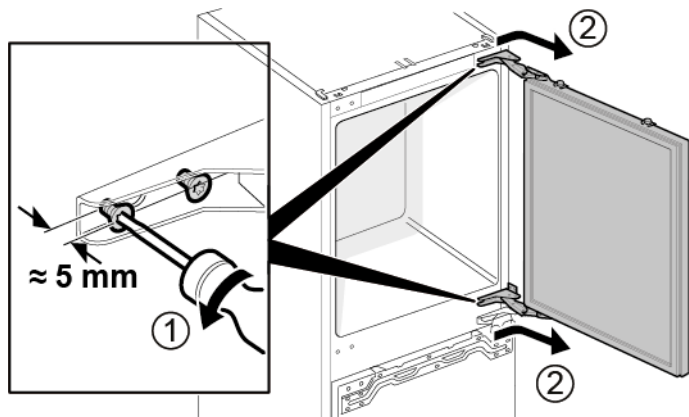

3. 1. Išsukite keturis varžtus (1).  
2. Nuimkite vyrius (2).

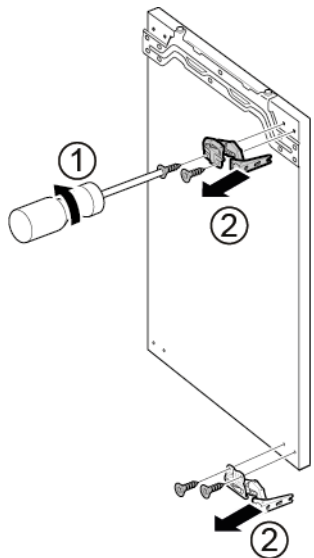

 Viršutinių durelių vyriai nuimti.

4. 1. Atleiskite keturis varžtus (1).  
2. Patraukite ir išimkite apatines dureles (2).

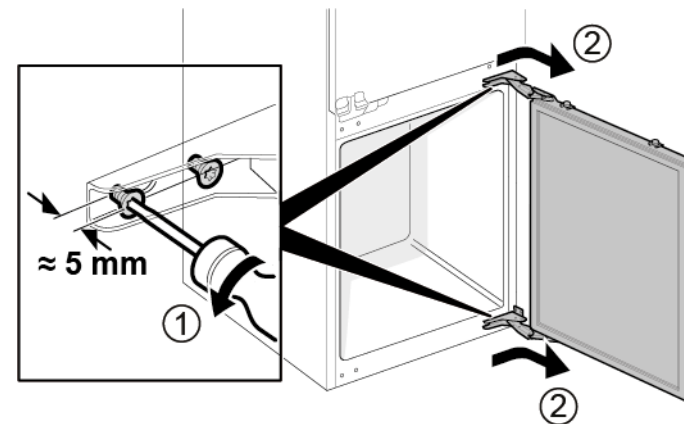

5. 1. Išsukite keturis varžtus (1).  
2. Nuimkite vyrius (2).

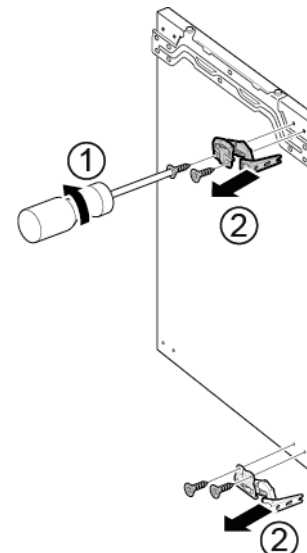

 Apatinių durelių vyriai nuimti.





#### **4.2.2 Atlenkiamo vyro montavimas**

- ▶ Uždėkite atvirkščią eilės tvarką.

## 4.3 Slankiojo vyro keitimas

### Specialūs įrankiai.

„Torx“ antgalis TX20 6,3 mm (1/4 col.) [00340865]

	<p style="text-align: center;"><b>⚠️ ĮSPĖJIMAS</b></p> <p><b>Sunkūs ir dideli prietaisai!</b> Nugaros ir raumenų sužalojimai</p> <ul style="list-style-type: none"> <li>▶ Prietaiso dureles nuimti gali tik apmokyti specialistai.</li> <li>▶ Norint perkelti prietaisą į kitą vietą, reikalingi du žmonės.</li> <li>▶ Naudokite tik tinkamus įrankius ir įrangą.</li> </ul>
	<p style="text-align: center;"><b>⚠️ PERSPĖJIMAS</b></p> <p><b>Aštrios briaunos!</b> Galima įsipjauti</p> <ul style="list-style-type: none"> <li>▶ Mūvėkite apsaugines pirštines.</li> </ul>
	<p style="text-align: center;"><b>⚠️ PERSPĖJIMAS</b></p> <p><b>Pavojus, kad atpalaidavus varžtus dalys nukris!</b> Krentančios dalys gali sužeisti.</p> <ul style="list-style-type: none"> <li>▶ Apsaugokite konstrukcinę dalį, kad ji nenukristų.</li> </ul>
	<p style="text-align: center;"><b>⚠️ DĖMESIO!</b></p> <p><b>Pavojus, kad atpalaidavus varžtus dalys nukris!</b> Gali būti sugadintos kitos prietaiso dalys arba kliento namai, pvz., grindys.</p> <ul style="list-style-type: none"> <li>▶ Apsaugokite konstrukcinę dalį, kad ji nenukristų.</li> </ul>

### Reikalavimas.

- ✔️ Prietaisas turi būti atjungtas nuo maitinimo šaltinio.
- ✔️ Baldų ir prietaiso durelės yra atskiros. Žr. „Įrengimo instrukcija“.

### 4.3.1 Slankiojo vyro nuėmimas

1. Išsukite du varžtus (1).
2. Nuimkite viršutinių durelių viršutinį vyrį (2).
3. Nuimkite viršutines dureles (3).
4. Išsukite du varžtus (4).
5. Nuimkite apatinių durelių viršutinį vyrį (5).
6. Nuimkite apatines dureles (6).

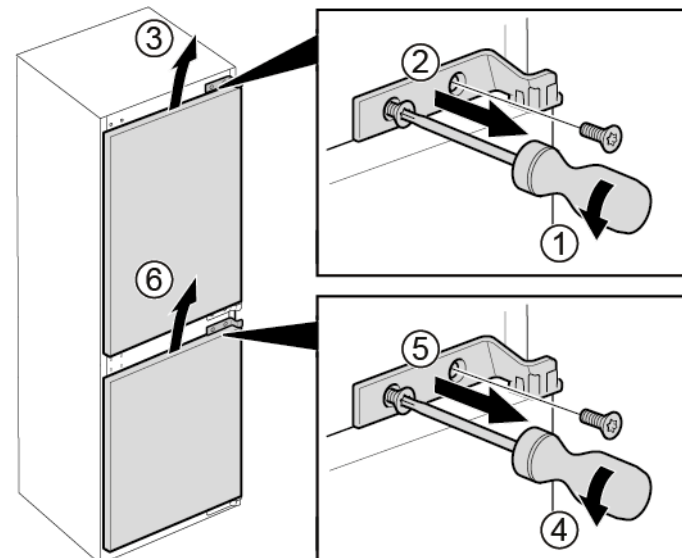

2. 1. Išsukite keturis varžtus (1).
2. Nuimkite apatinius vyrius (2).

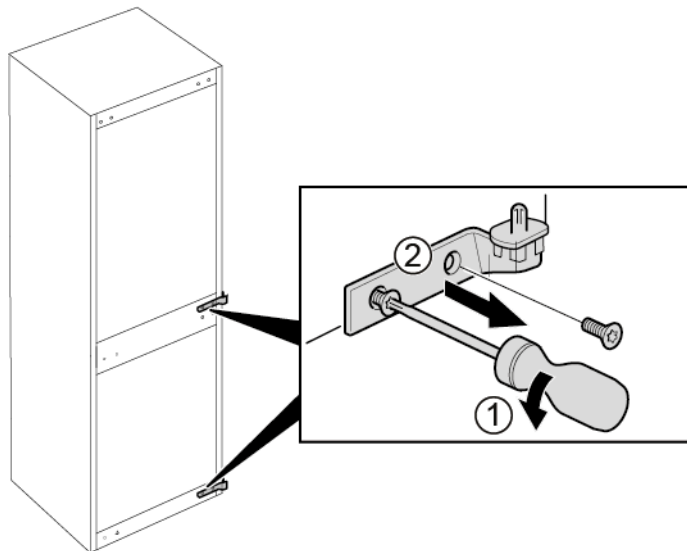

 Vyriai nuimti.

### 4.3.2 Slankiojo vyro montavimas

- ▶ Uždėkite atvirkščia eilės tvarka.

## 4.4 Durelių lentynos keitimas

Reikalavimas.

- ✔ Durelės turi būti atidarytos.

### 4.4.1 Durelių lentynos išėmimas

- ▶ Pakelkite durelių lentyną į viršų.

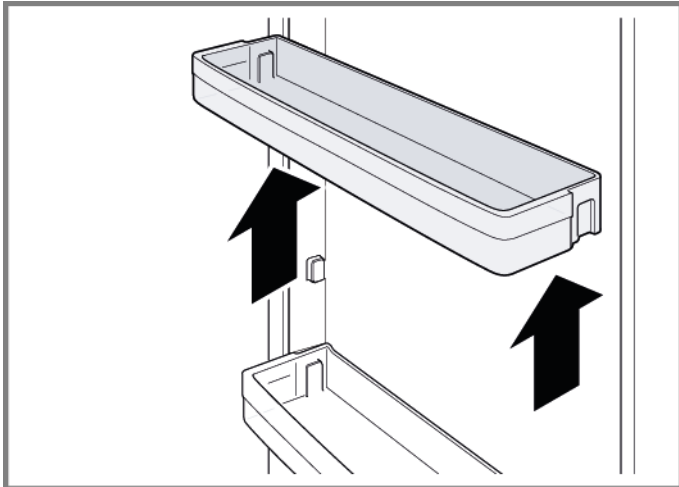

- ➡ Durelių lentyna išimta.

### 4.4.2 Durelių lentynos įdėjimas

- ▶ Uždėkite atvirkščia eilės tvarka.

## 4.5 Lentynos keitimas

### Reikalavimas.

- ✔ Durelės turi būti atidarytos.

### 4.5.1 Lentynos nuėmimas

- ▶ Ištraukite lentyną.

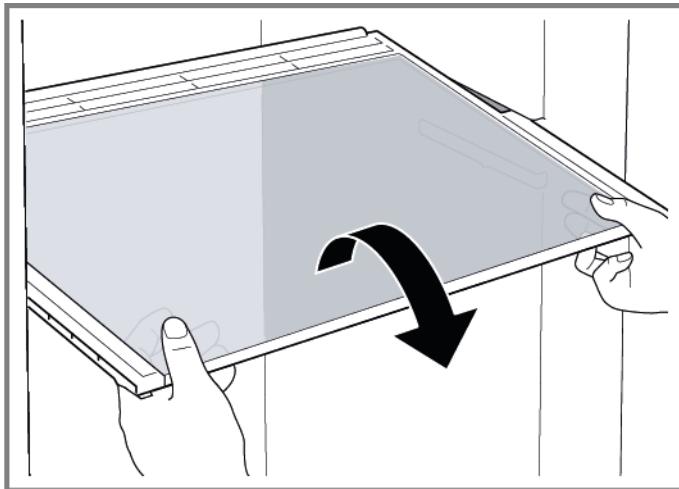

- ➔ Lentyna išimta.

### 4.5.2 Lentynos įdėjimas

- ▶ Uždėkite atvirkščia eilės tvarka.



## 4.6 Ištraukiamos lentynos keitimas

### Reikalavimas.

- ✔ Durelės turi būti atidarytos.

### 4.6.1 Ištraukiamos lentynos išėmimas

1. Traukite ištraukiamą lentyną, kol atsifiksuos fikсatorius.

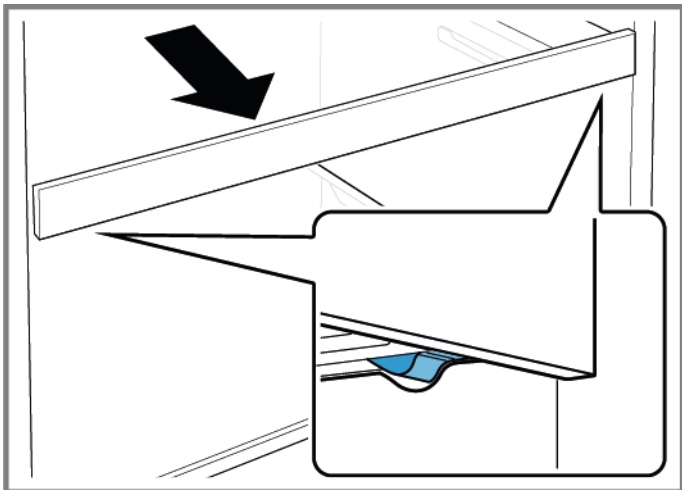

2. Nuleiskite ištraukiamą lentyną ir pakreipkite į šoną.
3. ➡ Ištraukiama lentyna išimta.

### 4.6.2 Ištraukiamos lentynos įdėjimas

- ▶ Uždėkite atvirkščia eilės tvarka.

## 4.7 Šaldiklio skyriaus lentynos keitimas

Reikalavimas.

- ✔ Durelės turi būti atidarytos.

### 4.7.1 Šaldiklio skyriaus lentynos išėmimas

- ▶ Ištraukite šaldiklio skyriaus lentyną.

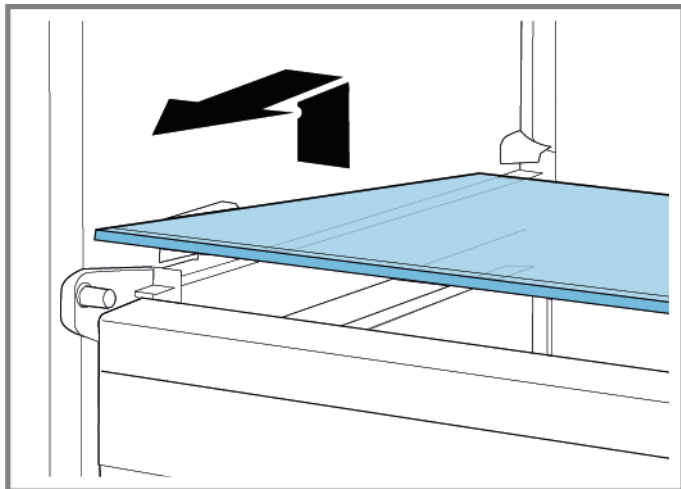

- ➡ Šaldiklio skyriaus lentyna išimta.

### 4.7.2 Šaldiklio skyriaus lentynos įdėjimas

- ▶ Uždėkite atvirkščia eilės tvarka.

## 4.8 Šaldytų maisto produktų talpyklos keitimas

### Reikalavimas.

- ✔ Durelės turi būti atidarytos.

### 4.8.1 Šaldytų maisto produktų talpyklos išėmimas

- ▶ 1. Ištraukite šaldytų maisto produktų talpyklą iki pat galo (1).
- ▶ 2. Išimkite šaldytų maisto produktų talpyklą (2).

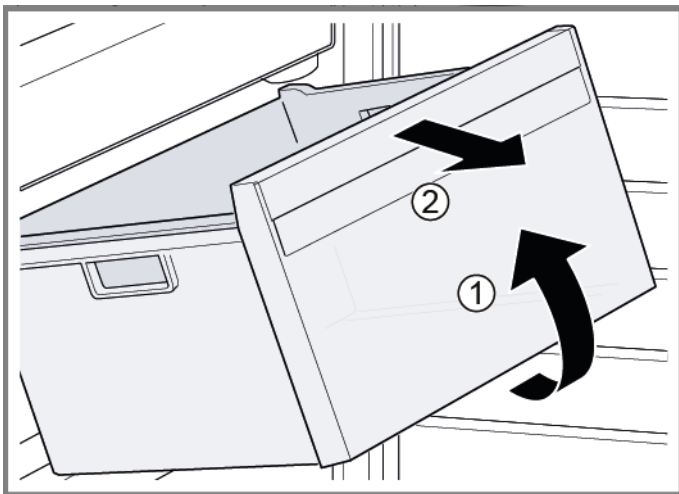

- ➡ Šaldytų maisto produktų talpykla išimta.

### 4.8.2 Šaldytų maisto produktų talpyklos įdėjimas

- ▶ Uždėkite atvirkščia eilės tvarka.

## 4.9 Vaisių ir daržovių talpyklos keitimas

### Reikalavimas.

- ✔ Durelės turi būti atidarytos.

### 4.9.1 Vaisių ir daržovių talpyklos išėmimas

- ▶ 1. Ištraukite talpyklą iki pat galo (1).
- ▶ 2. Išimkite talpyklą (2).

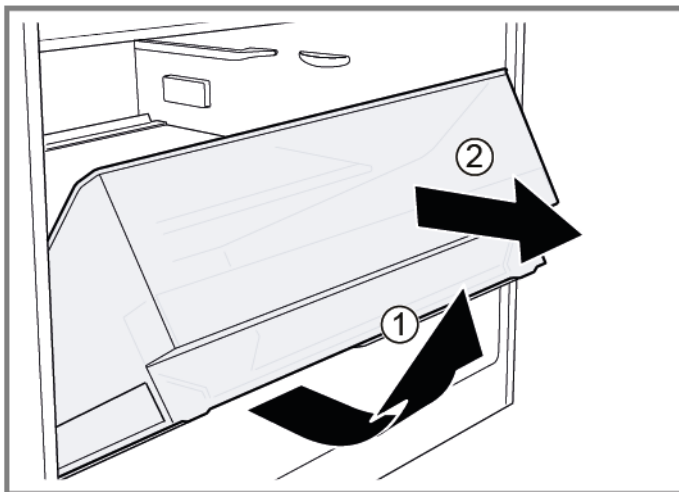

- ➡ Talpykla išimta.

### 4.9.2 Vaisių ir daržovių talpyklos įdėjimas

- ▶ Uždėkite atvirkščia eilės tvarka.

## 4.10 Vaisių ir daržovių talpyklos pertvaros ir dangčio keitimas

### Reikalavimas.

- ✔ Durelės turi būti atidarytos.

### 4.10.1 Vaisių ir daržovių talpyklos pertvaros išėmimas ir dangčio nuėmimas

1. Nuimkite nuo pertvaros stiklinę plokštelę.

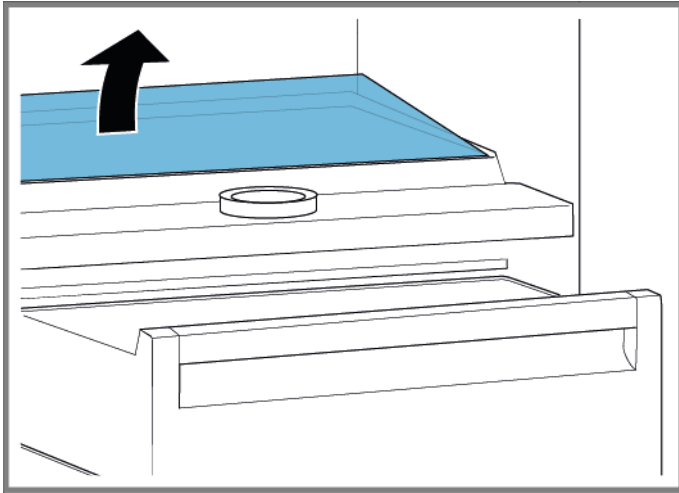

2. [Išimkite vaisių ir daržovių talpyklą.→356](#)

3. 1. Abiejose pertvaros pusėse apačioje nuspauskite svirtelę (1).
2. Patraukite pertvarą į priekį (2).

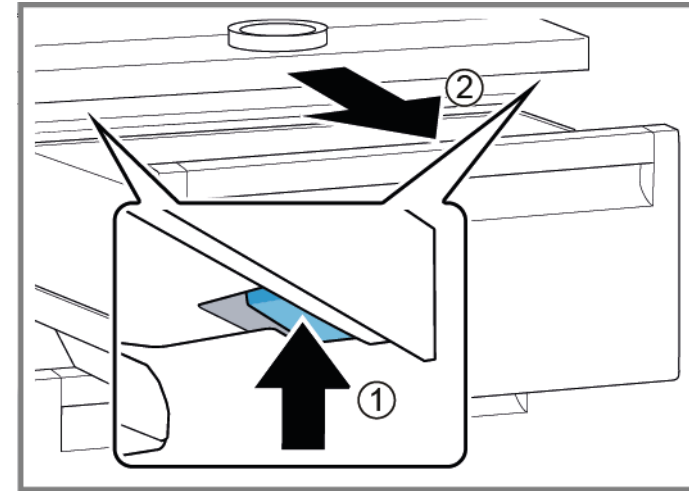

4. Pakelkite pertvarą ir pakreipkite šonu.  
➡ Pertvara išimta.
5. 1. Iškelkite vaisių ir daržovių talpyklos dangtį.  
2. Patraukite vaisių ir daržovių talpyklos dangtį į priekį ir pakreipkite šonu.  
➡ Vaisių ir daržovių talpyklos dangtis nuimtas.

### 4.10.2 Vaisių ir daržovių talpyklos pertvaros įdėjimas ir dangčio uždėjimas

- ▶ Uždėkite atvirkščia eilės tvarka.

## 4.11 Atšaldytų šviežių produktų talpyklos keitimas

### Reikalavimas.

- ✔ Durelės turi būti atidarytos.

### 4.11.1 Atšaldytų šviežių produktų talpyklos išėmimas

- ▶ 1. Palenkite šviežių produktų talpyklą į priekį (1).
- ▶ 2. Išimkite atšaldytų šviežių produktų talpyklą (2).

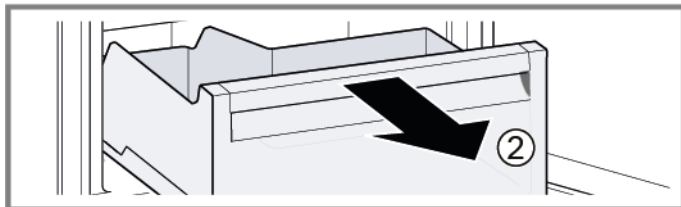
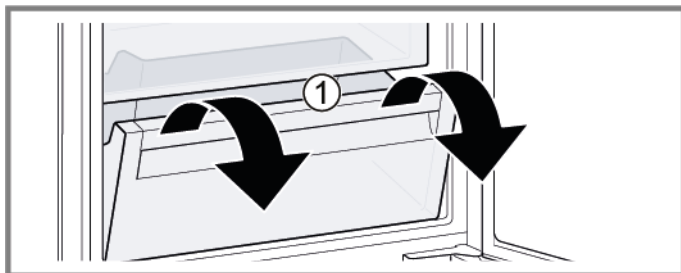

- ➡ Atšaldytų šviežių produktų talpykla išimta.

### 4.11.2 Atšaldytų šviežių produktų talpyklos įdėjimas

- ▶ Uždėkite atvirkščia eilės tvarka.

## 4.12 Ištraukiamos talpyklos keitimas

### Reikalavimas.

- ✔ Durelės turi būti atidarytos.

### 4.12.1 Ištraukiamos talpyklos išėmimas

- ▶ 1. Palenkite ištraukiamą talpyklą į priekį (1).
- ▶ 2. Išimkite ištraukiamą talpyklą (2).

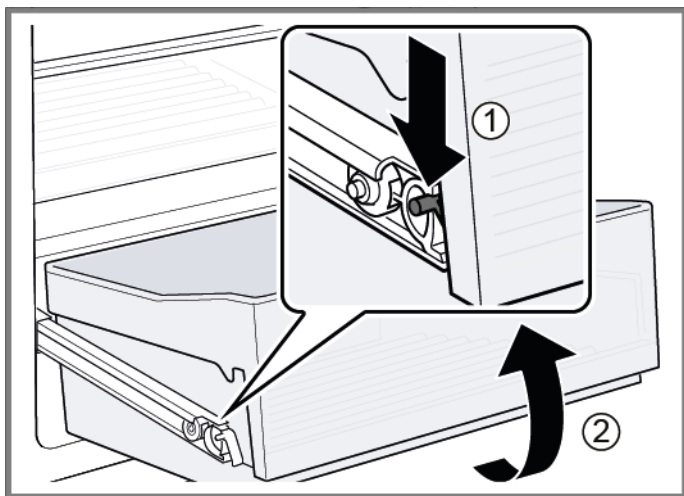

➡ Ištraukiama talpykla išimta.

### 4.12.2 Ištraukiamos talpyklos įdėjimas

- ▶ Uždėkite atvirkščia eilės tvarka.

## 4.13 LED apšvietimo lemputės keitimas

### Specialūs įrankiai.

- Specialus įrankis [00342180]
- Atsuktuvus su įpjovomis Mentė 2,4 mm x 0,4 mm x 60 mm, rinkinyje [00341820]

**i** Jūsų prietaise įrengta techninės priežiūros nereikalaujanti LED lemputė. Šią lemputę gali taisyti tik klientų aptarnavimo tarnybos specialistai arba įgalioti technikai!

**⚠ PAVOJUS**  
**Elektros smūgio pavojus dėl dalių, kuriose yra įtampa!**  
Pavojus gyvybei dėl elektros smūgio netinkamo remonto atveju

- ▶ Elektrinės dalis remontuoti turi kvalifikuoti elektrikai.
- ▶ Po remonto pasirūpinkite, kad būtų atliktas saugos bandymas pagal VDE 0701 arba šalyje galiojančius reglamentus.

**⚠ PAVOJUS**  
**Elektros smūgio pavojus dėl dalių, kuriose yra įtampa!**  
Mirtis dėl elektros smūgio

- ▶ Prieš pradėdami remontą, ne mažiau kaip prieš 60 sekundžių atjunkite prietaisus nuo elektros tiekimo.

**⚠ PERSPĖJIMAS**  
**Aštrios briaunos!**  
Galima įsijauti

- ▶ Mūvėkite apsaugines pirštines.

### Reikalavimas.

- ✔ Prietaisas turi būti atjungtas nuo maitinimo šaltinio.
- ✔ Durelės turi būti atidarytos.
- ✔ Šaldytuvo skyriaus lentynos išimtos.

### 4.13.1 LED apšvietimo lemputės išėmimas

1. Atleiskite LED apšvietimo lemputės dangtelį.

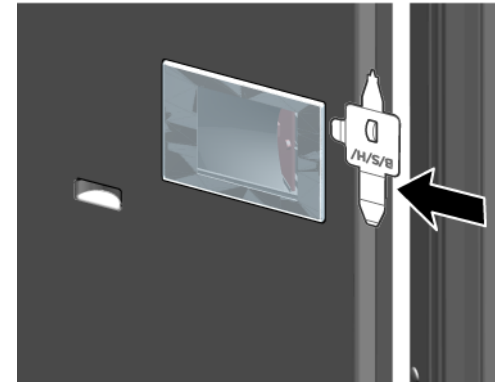

2. Patraukite LED apšvietimo lemputės dangtelį į vidų ir tuo pat metu paspauskite į priekį.

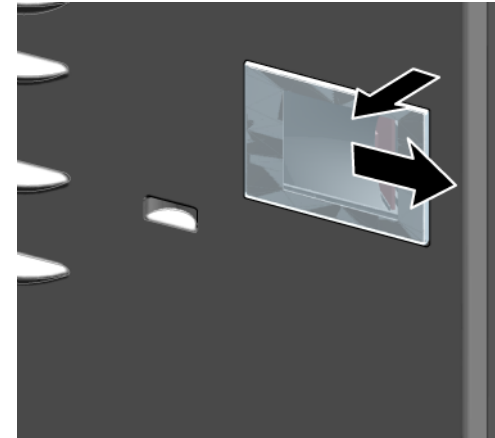



3. Atkabinkite LED apšvietimo lemputės modulį.

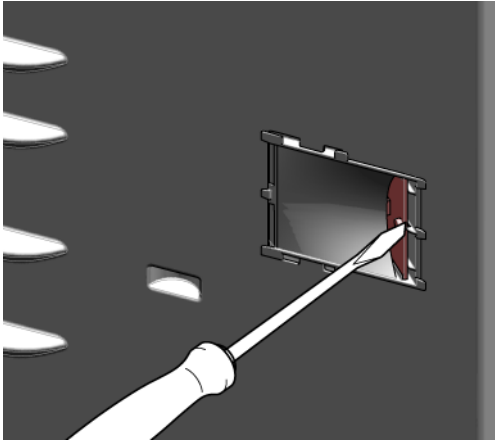

4. Atjunkite LED apšvietimo lemputės elektros jungtį.

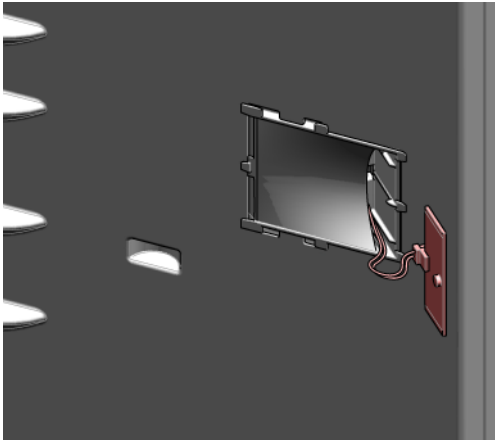





-  LED apšvietimo lemputė išimta.

### 4.13.2 LED apšvietimo lemputės montavimas

- ▶ Uždėkite atvirkščia eilės tvarka.

# Reparasjonstips - Kjøle-/frysekombinasjon

 <b>Om dette dokumentet</b> .....	<b>363</b>
1.1 Viktig informasjon .....	363
1.1.1 Formål.....	363
1.2 Forklaring av symboler.....	363
1.2.1 Farenivåer .....	363
1.2.2 Faresymboler.....	363
1.2.3 Advarslenes struktur .....	364
1.2.4 Generelle symboler .....	364
 <b>Sikkerhet</b> .....	<b>365</b>
2.1 Generelle sikkerhetsinstruksjoner .....	365
2.1.1 Alle husholdningsapparater .....	365
 <b>Verktøy og hjelpemidler</b> .....	<b>366</b>
 <b>Reparasjon</b> .....	<b>367</b>
4.1 Utskiftning av dørpakning.....	367
4.1.1 Demontering av dørpakning.....	367
4.1.2 Montering av dørpakning .....	367
4.2 Utskiftning av flat hengsel .....	370
4.2.1 Demontering av flat hengsel .....	370
4.2.2 Montering av flat hengsel.....	372
4.3 Utskiftning av glidehengsel.....	373
4.3.1 Demontering av glidehengsel.....	373
4.3.2 Montering av glidehengsel .....	374
4.4 Utskiftning av dørrack .....	375
4.4.1 Demontering av dørrack .....	375
4.4.2 Montering av dørrack .....	375
4.5 Utskiftning av hylle.....	376
4.5.1 Demontering av hylle.....	376
4.5.2 Montering av hylle .....	376
4.6 Utskiftning av uttrekkbar hylle.....	377
4.6.1 Demontering av uttrekkbar hylle.....	377
4.6.2 Montering av uttrekkbar hylle .....	377
4.7 Utskiftning av hylle i fryser.....	378
4.7.1 Demontering av hylle i fryser.....	378
4.7.2 Montering av hylle i fryser.....	378
4.8 Utskiftning av beholder for frysevarer .....	379
4.8.1 Demontering av beholder for frysevarer .....	379
4.8.2 Montering av beholder for frysevarer .....	379
4.9 Utskiftning av frukt- og grønnsaksbeholder .....	380
4.9.1 Demontering av frukt- og grønnsaksbeholder .....	380
4.9.2 Montering av frukt- og grønnsaksbeholder .....	380
4.10 Utskiftning av skillevegg og deksel for frukt- og grønnsaksbeholder .....	381
4.10.1 Demontering av skillevegg og deksel for frukt- og grønnsaksbeholder.....	381
4.10.2 Montering av skillevegg og deksel for frukt- og grønnsaksbeholder.....	381
4.11 Utskiftning av Cool-Fresh-beholder .....	382
4.11.1 Demontering av Cool-Fresh-beholder .....	382
4.11.2 Montering av Cool-Fresh-beholder .....	382
4.12 Utskiftning av uttrekkbar beholder .....	383
4.12.1 Demontering av uttrekkbar beholder .....	383
4.12.2 Montering av uttrekkbar beholder .....	383
4.13 Utskiftning av LED-spotlight.....	384
4.13.1 Demontering av LED-spotlight.....	384
4.13.2 Montering av LED-spotlight .....	385

# i Om dette dokumentet

## 1.1 Viktig informasjon

### 1.1.1 Formål

Disse tipsene om reparasjon skal hjelpe kunden til selv å kunne reparere apparater i samsvar med gjeldende regulering av øko-design (med gyldighet 03/2021).



De inneholder informasjon om hvordan definerte reservedeler skiftes, inklusive advarsler og risikoer.

Kontakt vår kundeservice dersom du har spørsmål. Vi påtar oss kun ansvar for skader dersom tipsene om reparasjon er korrekt fulgt.

## 1.2 Forklaring av symboler

### 1.2.1 Farenivåer

Advarslene som viser farenivå, består av et symbol og et signalord. Signalordet viser hvor alvorlig faren er.





Advarsel som viser farenivå	Betydning
	Dersom advarselen ignoreres, vil det føre til død eller alvorlige personskader.
	Dersom advarselen ignoreres, kan det føre til død eller alvorlige personskader.
	Dersom advarselen ignoreres, kan det føre til mindre personskader.
	Dersom advarselen ignoreres, kan det føre til materiell skade.

Tabell 1: Farenivåer



### 1.2.2 Faresymboler

Faresymboler er symbolske fremstillinger som gir en indikasjon av hvilken type fare det dreier seg om.

Følgende faresymboler brukes i dette dokumentet:

Faresymbol	Betydning
	Generell advarsel
	Fare for elektrisk støt
	Eksplisjonsfare
	Fare for å skjære seg
	Klemfare

## **i** Om dette dokumentet

Faresymbol	Betydning
	Fare på grunn av varme overflater
	Fare på grunn av sterkt magnetfelt
	Fare fra ikke-ioniserende stråling

Tabell 2: Faresymboler

### 1.2.3 Advarslenes struktur

Advarslene i dette dokumentet har standardisert utseende og standardisert struktur.



	<div style="background-color: red; color: white; padding: 2px; text-align: center;"><b>FARE</b></div> <p><b>Faretype og kilde til fare!</b> Mulige konsekvenser dersom fare/advarsel ignoreres.</p> <ul style="list-style-type: none"> <li>▶ Tiltak og forbud for å forebygge fare.</li> </ul>
--	--





Eksemplet nedenfor viser en advarsel mot elektrisk støt på grunn av strømførende deler. Tiltaket for å unngå faren er angitt.

	<div style="background-color: red; color: white; padding: 2px; text-align: center;"><b>FARE</b></div> <p><b>Fare for elektrisk støt på grunn av strømførende deler!</b> Død på grunn av drepende elektrisk støt</p> <ul style="list-style-type: none"> <li>▶ Koble apparatene fra strømforsyningen i minst 60 sekunder før reparasjonene startes.</li> </ul>
---	--

### 1.2.4 Generelle symboler

Følgende generelle symboler brukes i dette dokumentet:

Gen. symbol	Betydning
	Identifisering av et spesielt tips (tekst og/eller grafikk)
	Identifisering av et enkelt tips (kun tekst)
	Identifisering av en lenke til en opplæringsvideo

Gen. symbol	Betydning
	Identifisering av nødvendig verktøy
	Identifisering av nødvendige forutsetninger
	Identifisering av en betingelse (hvis ..., så ...)
	Identifisering av et resultat
[Start]	Identifisering av en tast eller knapp
[00123456]	Identifisering av et materialnummer
Status	Identifisering av vist tekst/vindu (i apparatets display)

Tabell 3: Generelle symboler

## 2.1 Generelle sikkerhetsinstruksjoner

### 2.1.1 Alle husholdningsapparater

#### **Fare for elektrisk støt på grunn av strømførende deler!**

- Feil ved reparasjoner hvor elektriske komponenter er involvert, kan føre til elektrisk støt!
- Koble apparatet fra strømmettet i minst 60 sekunder før arbeidet startes.
- Etter reparasjonen må du sørge for at det utføres en sikkerhetstest iht. VDE 0701 eller gjeldende forskrifter i det respektive land.

#### **Fare for personskade på grunn av skarpe kanter!**

- Bruk vernehansker.

#### **Fare for å knuse legemsdeler under reparasjoner, vedlikehold, feilsøking og service på grunn av tunge og bevegelige komponenter**

- Bruk vernesko.
- Sikre tunge komponenter for å hindre at de faller ned.
- Ikke stikk kroppsdelene inn i bevegelige komponenter.



#### **Fare for apparatets sikkerhet/funksjon!**

- Bruk kun originale reservedeler.

#### **Fare for skade på deler som er følsomme overfor elektrostatisk utlading (ESD)!**

- Ikke berør modulene, inklusive tilkoblinger og ledere.

## Verktøy og hjelpemidler

Betegnelsen	Detaljer	Bilder
Beskyttelsesklut [00342013]	60 cm x 50 cm	
Torx-bits TX20 [00340865]	6,3 mm (1/4")	
Spesialverktøy [00342180]		

## 4.1 Utskiftning av dørpakning

### Forutsetning:

- ✔ Døren er åpen.

### 4.1.1 Demontering av dørpakning

1. Løsne dørpakningen fra sporet i høyre og venstre hjørne.

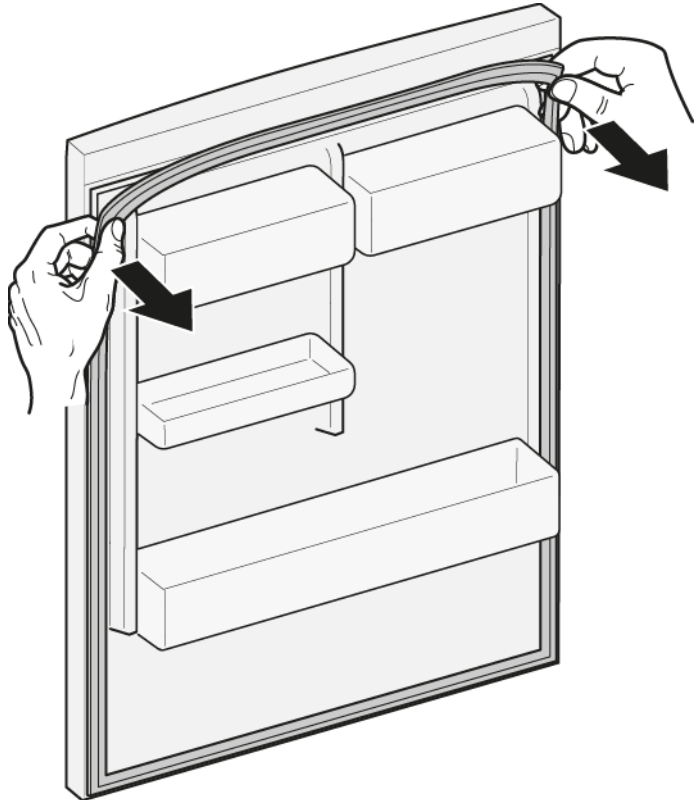

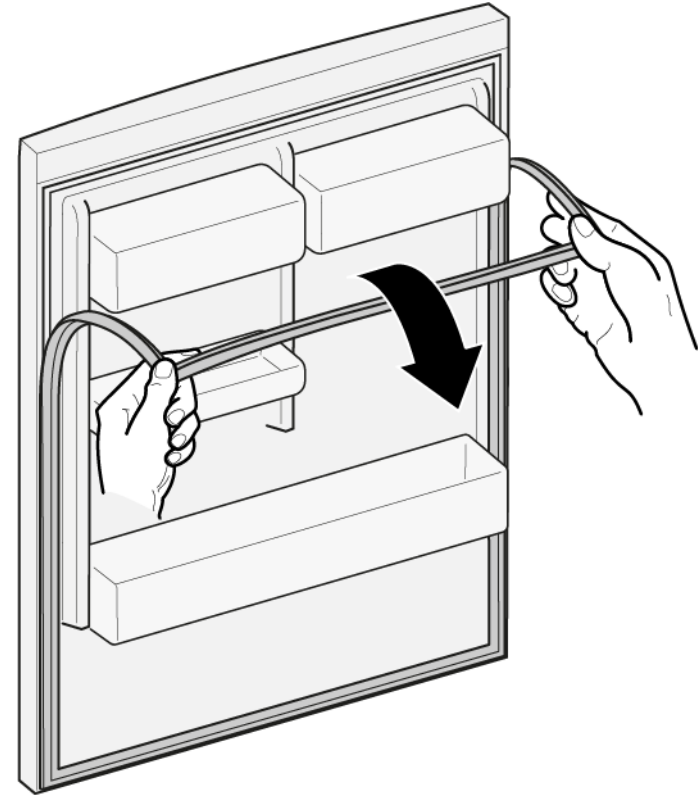

2. Trekk pakningen ut av sporet.



- ➡ Dørpakningen er demontert.

### 4.1.2 Montering av dørpakning

	Tykkelsen på den nye dørpakningen kan avvike litt fra tykkelsen på den gamle dørpakningen. Det har ingen innvirkning på lukkeatferd og langvarig funksjon.
	Hvis apparatet har justerbare hengsler eller hengslefester, kan du optimalisere lukkeatferden etterpå.
	Små sidehull i dørpakningen har en funksjon (nødvendige for ventilasjonen). Det dreier seg ikke om produksjonsfeil.

## Reparasjon

1. Kontroller at sporet for pakningen ikke har skader.

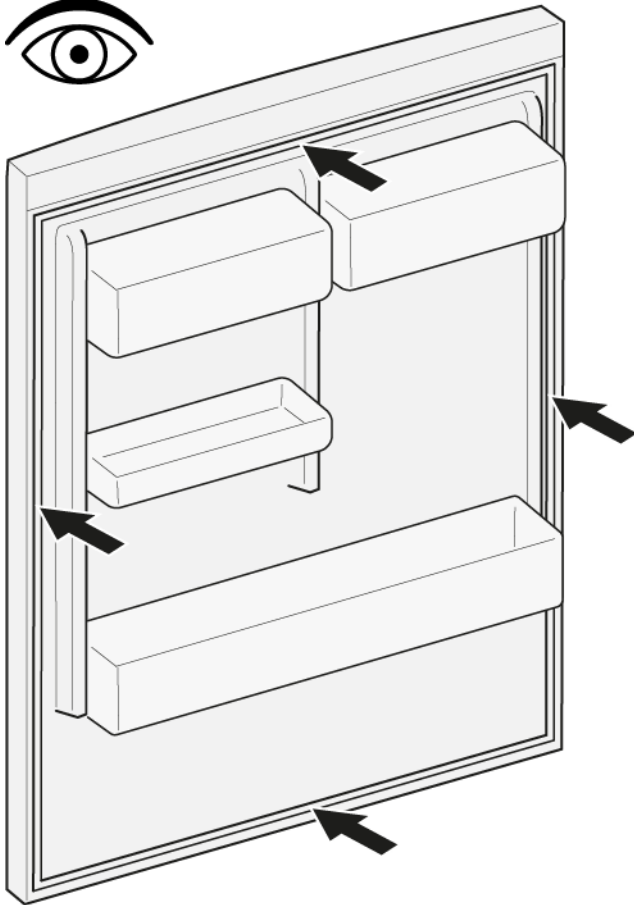

2.  Hvis sporet for pakningen er skadet:
  - Kontakt kundeservice.

3.  Litt deformasjon av dørpakningen er normalt og har ingen innvirkning på funksjonen. Det anbefales å rette ut dørpakningen før den settes inn i apparatet.

Varm opp dørpakningen med en føn eller varmt vann og form den på nytt med hendene.

4. Skyv pakningens hjørner øverst og nederst inn i sporet.

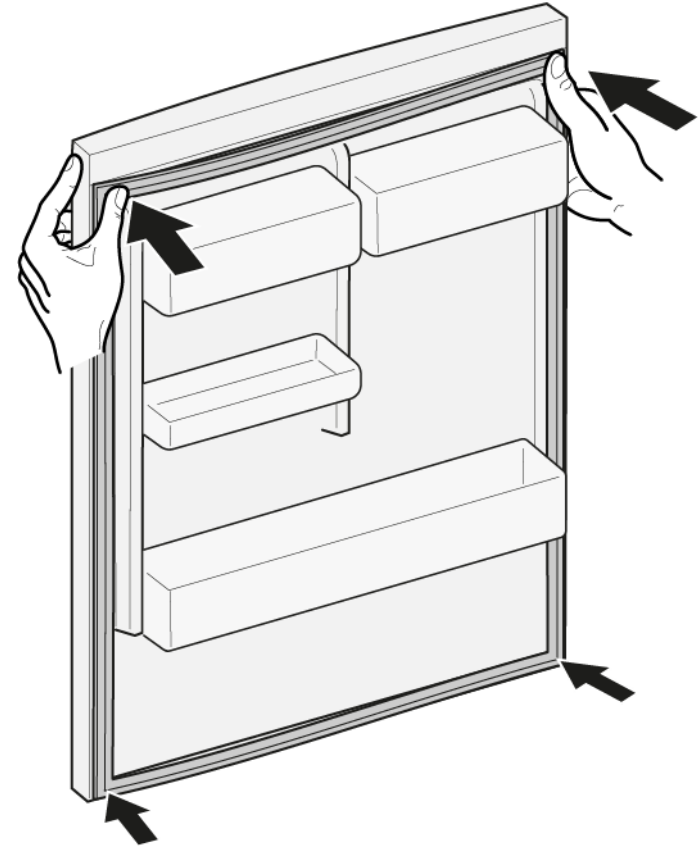



## Reparasjon

5. Trykk hele pakningen inn i sporet trinn for trinn.

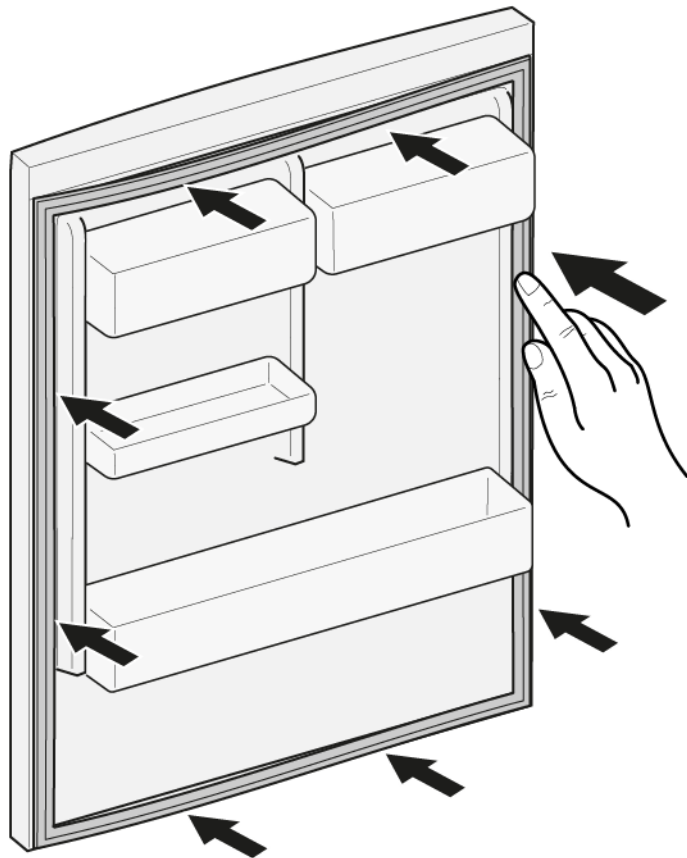

 Dørpakningen er montert.

## 4.2 Utskiftning av flat hengsel

### Spesielle hjelpemidler:

Torx-bits TX20

6,3 mm (1/4")

[00340865]



#### ADVARSEL

##### Tunge, klumpete apparater!

Rygg- og muskelskader

- ▶ Arbeidet med å demontere apparatets dør skal bare utføres av opplærte spesialister.
- ▶ Det kreves to personer for å flytte på apparatet.
- ▶ Bruk kun egnet verktøy og utstyr.



#### FORSIKTIG

##### Skarpe kanter!

Kuttskader

- ▶ Bruk vernehansker.



#### FORSIKTIG

##### Åpent hengsleområde!

Fare for å knuse/sette fast fingre

- ▶ Ikke grip inn i hengsleområdet.
- ▶ Bruk vernehansker.



#### FORSIKTIG

##### Fare for at deler kan falle ned på grunn av løsnede skruer!

Personskade på grunn av fallende deler.

- ▶ Sikre komponenten så den ikke kan falle ned.



#### OBS!

##### Fare for at deler kan falle ned på grunn av løsnede skruer!

Skade på andre deler på apparatet eller i kundens hjem, f.eks. gulv.

- ▶ Sikre komponenten så den ikke kan falle ned.

### Forutsetning:

- ✔ Apparatet kobles fra strømforsyningen.
- ✔ Dør på møbel er demontert. Se monteringsanvisningen.
- ✔ Døren er åpen.

## 4.2.1 Demontering av flat hengsel

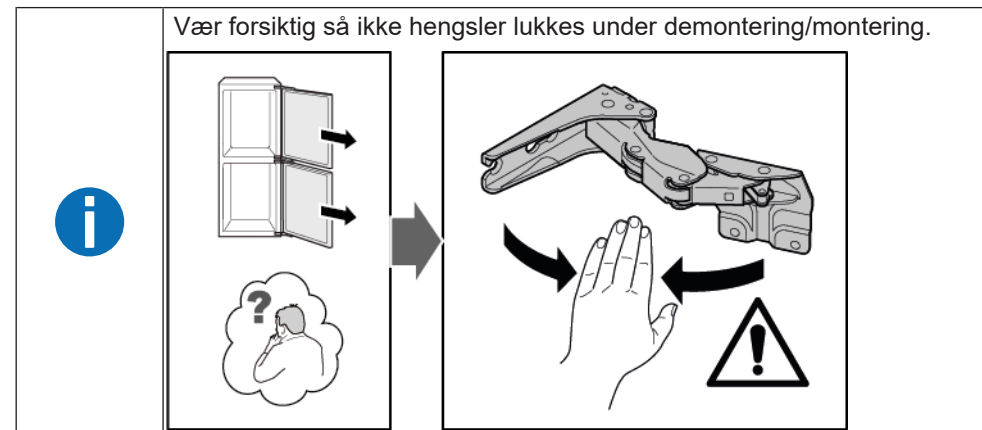

1. Ta av fire hengsledeksler.

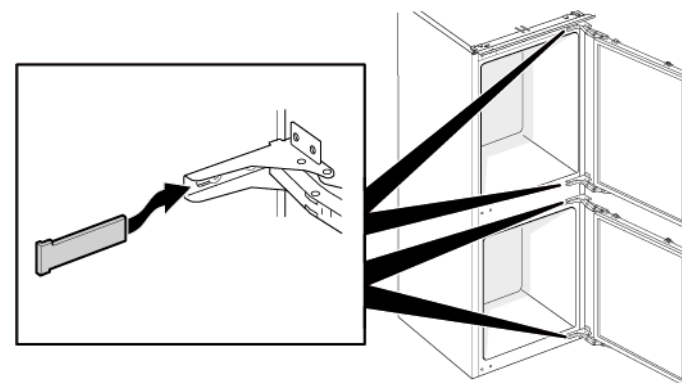

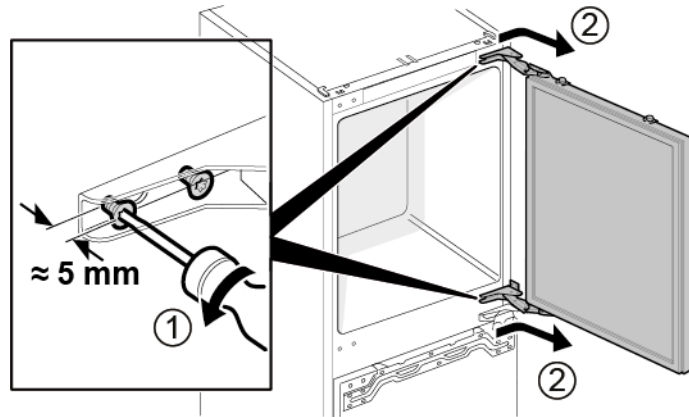

## Reparasjon

2. 1. Løsne fire skruer (1).  
2. Skyv ut og demonter den øvre døren (2).

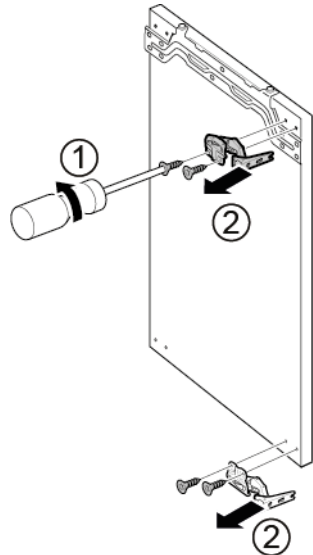

3. 1. Fjern fire skruer (1).  
2. Demonter hengslene (2).



 De øvre dørhengslene er demontert.

4. 1. Løsne fire skruer (1).  
2. Skyv ut og demonter den nedre døren (2).

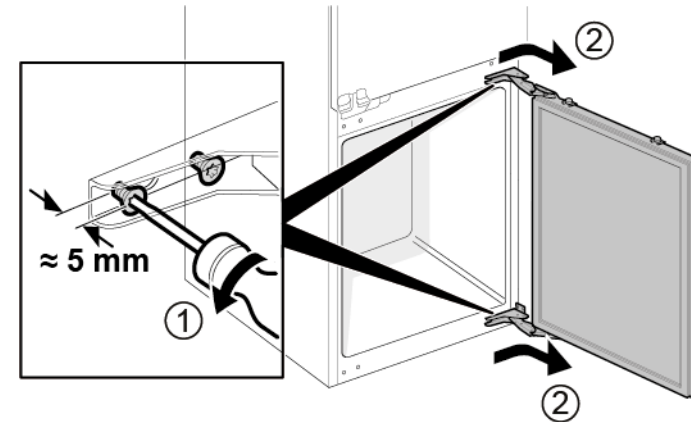

5. 1. Fjern fire skruer (1).  
2. Demonter hengslene (2).

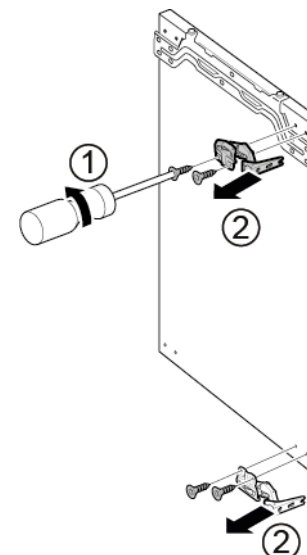

 De nedre dørhengslene er demontert.

## 4.2.2 Montering av flat hengsel

- ▶ Monteres i motsatt rekkefølge.

## 4.3 Utskiftning av glidehengsel

### Spesielle hjelpemidler:

🌀 Torx-bits TX20      6,3 mm (1/4")      [00340865]

	<b>⚠ ADVARSEL</b>
	<b>Tunge, klumpete apparater!</b> Rygg- og muskelskader <ul style="list-style-type: none"><li>▶ Arbeidet med å demontere apparatets dør skal bare utføres av opplærte spesialister.</li><li>▶ Det kreves to personer for å flytte på apparatet.</li><li>▶ Bruk kun egnet verktøy og utstyr.</li></ul>

	<b>⚠ FORSIKTIG</b>
	<b>Skarpe kanter!</b> Kuttskader <ul style="list-style-type: none"><li>▶ Bruk vernehansker.</li></ul>

	<b>⚠ FORSIKTIG</b>
	<b>Fare for at deler kan falle ned på grunn av løsnede skruer!</b> Personskade på grunn av fallende deler. <ul style="list-style-type: none"><li>▶ Sikre komponenten så den ikke kan falle ned.</li></ul>

	<b>OBS!</b>
	<b>Fare for at deler kan falle ned på grunn av løsnede skruer!</b> Skade på andre deler på apparatet eller i kundens hjem, f.eks. gulv. <ul style="list-style-type: none"><li>▶ Sikre komponenten så den ikke kan falle ned.</li></ul>

### Forutsetning:

- ✔ Apparatet kobles fra strømforsyningen.
- ✔ Dør på møbel og apparatets dør er skilt fra hverandre. Se monteringsanvisningen.

## 4.3.1 Demontering av glidehengsel

1. Skru ut to skruer (1).
2. Demonter øvre hengsel på øvre dør (2).
3. Demonter den øvre døren (3).
4. Skru ut to skruer (4).
5. Demonter øvre hengsel på nedre dør (5).
6. Demonter den nedre døren (6).

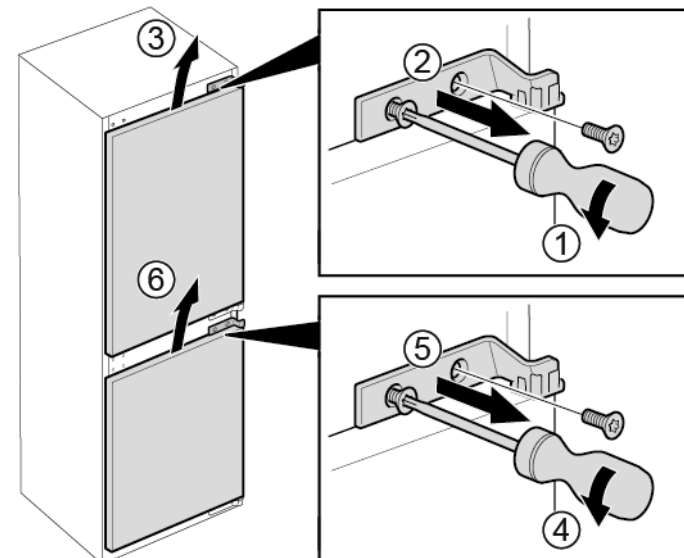

## Reparasjon

2. 1. Fjern fire skruer (1).
2. Demonter nedre hengsler (2).

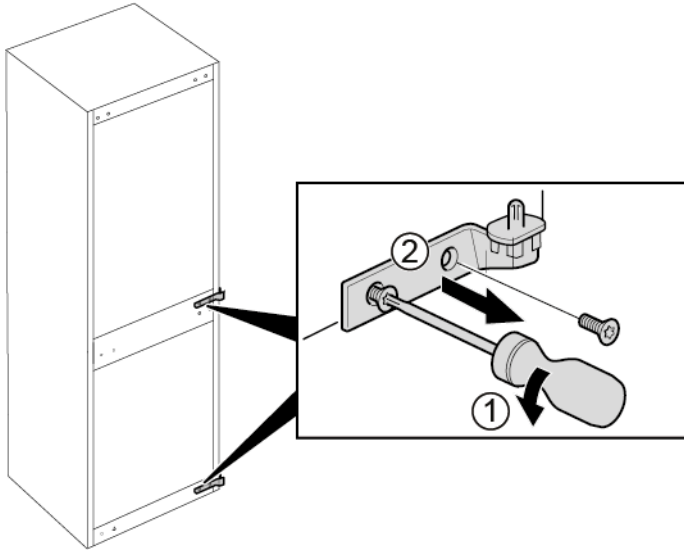

 Hengslene er demontert.

### 4.3.2 Montering av glidehengsel

- ▶ Monteres i motsatt rekkefølge.

## 4.4 Utskiftning av dørrack

### Forutsetning:

- ✔ Døren er åpen.

### 4.4.1 Demontering av dørrack

- ▶ Løft dørracken opp.

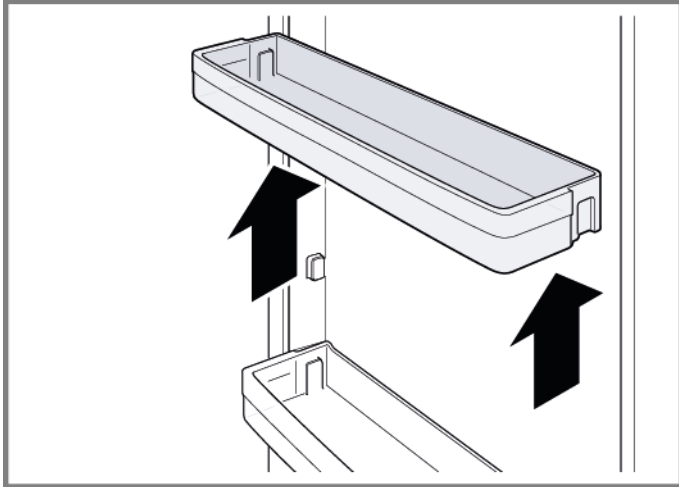

➡ Dørracken er demontert.

### 4.4.2 Montering av dørrack

- ▶ Monteres i motsatt rekkefølge.

## 4.5 Utskiftning av hylle

### Forutsetning:

- ✔ Døren er åpen.

### 4.5.1 Demontering av hylle

- ▶ Trekk ut hyllen.

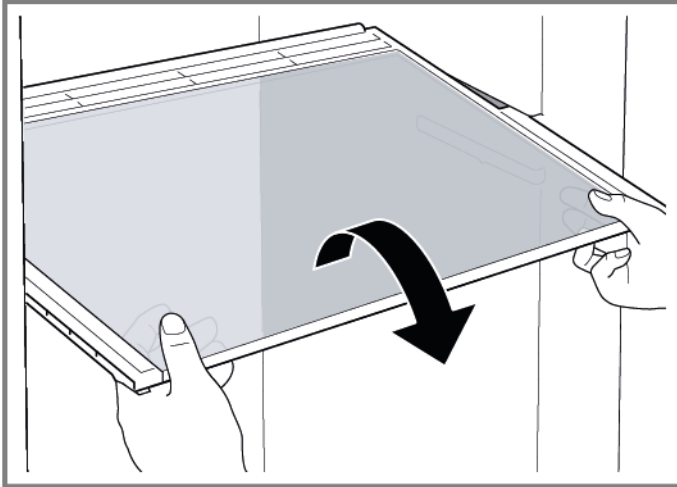

- ➡ Hyllen er demontert.

### 4.5.2 Montering av hylle

- ▶ Monteres i motsatt rekkefølge.



## 4.6 Utskiftning av uttrekkbar hylle

Forutsetning:

- ✔ Døren er åpen.

### 4.6.1 Demontering av uttrekkbar hylle

1. Trekk den uttrekkbare hyllen ut til låsehempen løsnes.

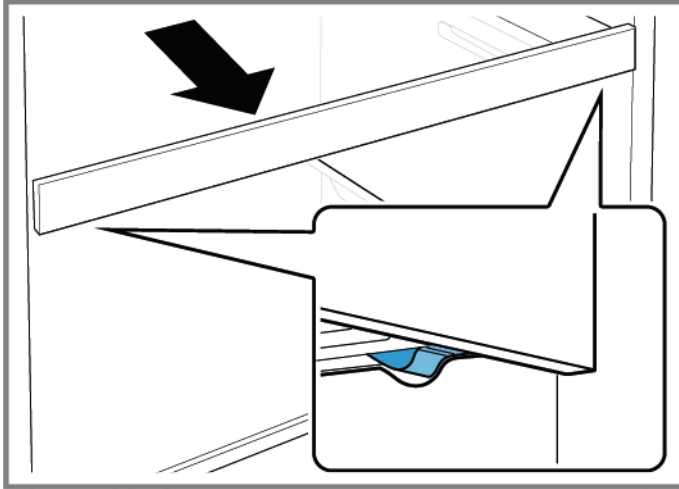

2. Senk den uttrekkbare hyllen ned og sving den ut til siden.
3.  Den uttrekkbare hyllen er demontert.

### 4.6.2 Montering av uttrekkbar hylle

- ▶ Monteres i motsatt rekkefølge.

## 4.7 Utskiftning av hylle i fryser

### Forutsetning:

- ✔ Døren er åpen.

### 4.7.1 Demontering av hylle i fryser

- ▶ Trekk ut hyllen i fryseren.

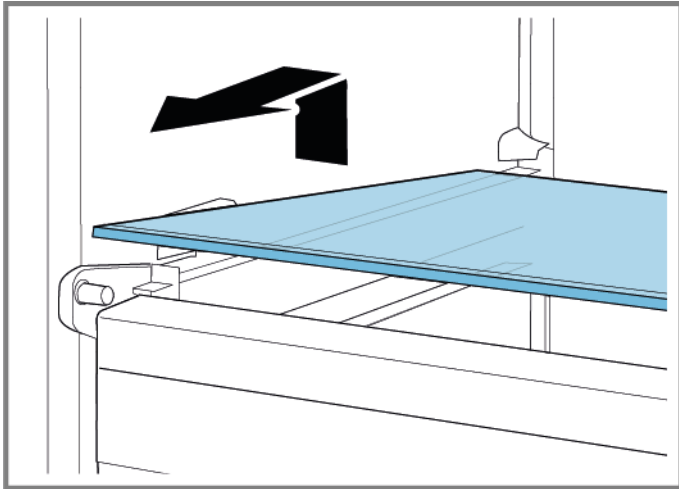

- ➡ Hyllen i fryseren er demontert.

### 4.7.2 Montering av hylle i fryser

- ▶ Monteres i motsatt rekkefølge.

## 4.8 Utskiftning av beholdere for frysevarer

### Forutsetning:

- ✔ Døren er åpen.

### 4.8.1 Demontering av beholdere for frysevarer

- ▶ 1. Trekk beholderen for frysevarer helt ut (1).
- ▶ 2. Ta ut beholderen for frysevarer (2).

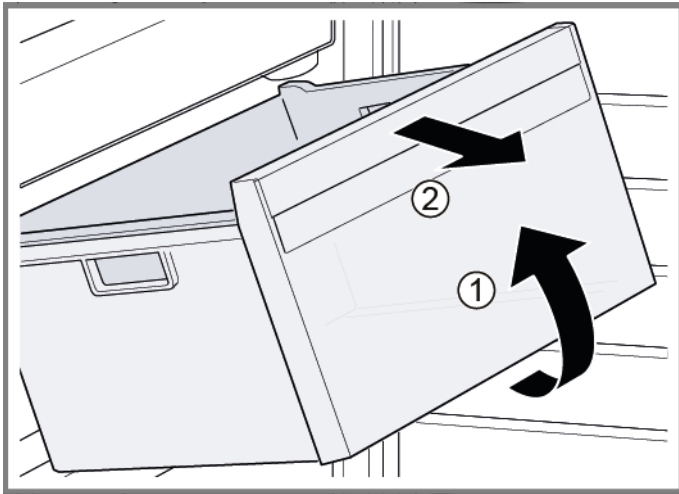

- ➡ Beholderen for frysevarer er demontert.

### 4.8.2 Montering av beholdere for frysevarer

- ▶ Monteres i motsatt rekkefølge.

## 4.9 Utskiftning av frukt- og grønnsaksbeholder

### Forutsetning:

- ✔ Døren er åpen.

### 4.9.1 Demontering av frukt- og grønnsaksbeholder

- ▶ 1. Trekk beholderen helt ut (1).
- ▶ 2. Fjern beholderen (2).

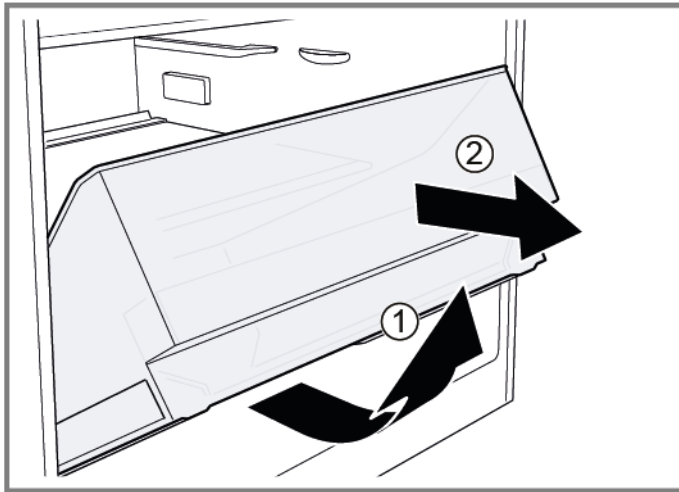

- ➡ Beholderen er demontert.

### 4.9.2 Montering av frukt- og grønnsaksbeholder

- ▶ Monteres i motsatt rekkefølge.

## 4.10 Utskiftning av skillevegg og deksel for frukt- og grønnsaksbeholder

### Forutsetning:

- ✔ Døren er åpen.

### 4.10.1 Demontering av skillevegg og deksel for frukt- og grønnsaksbeholder

1. Demonter glassplaten fra skilleveggen.

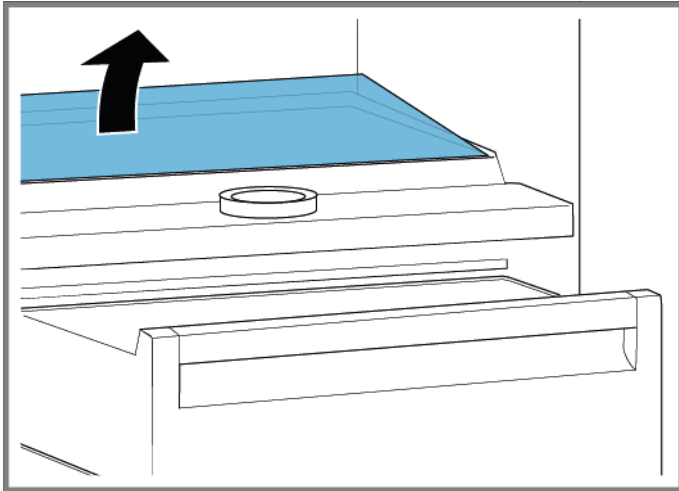

2. [Demonter frukt- og grønnsaksbeholderen. → 380](#)

3. 1. Trykk inn armen på undersiden på begge sider av skilleveggen (1).  
2. Trekk skilleveggen forover (2).

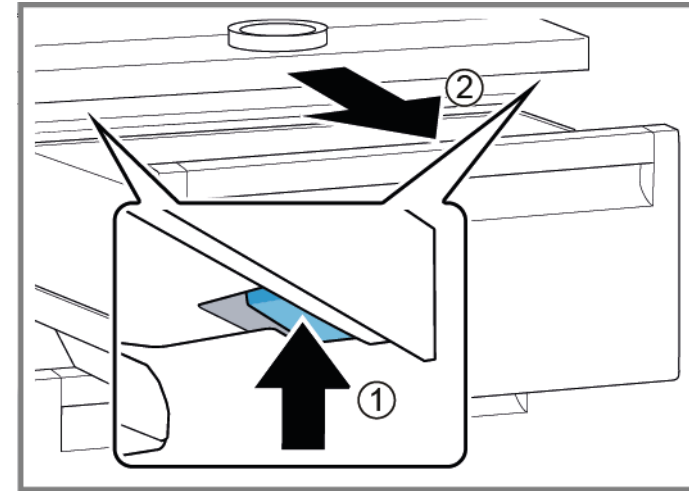

4. Løft skilleveggen og sving den ut til siden.  
➡ Skilleveggen er demontert.
5. 1. Løft dekslet av frukt- og grønnsaksbeholderen.  
2. Trekk lokket for frukt- og grønnsaksbeholderen forover og sving det ut til siden.  
➡ Dekslet for frukt- og grønnsaksbeholderen er demontert.

### 4.10.2 Montering av skillevegg og deksel for frukt- og grønnsaksbeholder

- ▶ Monteres i motsatt rekkefølge.

## 4.11 Utskiftning av Cool-Fresh-beholder

### Forutsetning:

- ✔ Døren er åpen.

### 4.11.1 Demontering av Cool-Fresh-beholder

- ▶ 1. Vipp Cool-Fresh-beholderen forover (1).
- ▶ 2. Ta ut Cool-Fresh-beholderen (2).

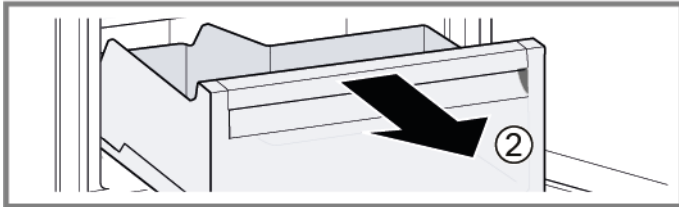
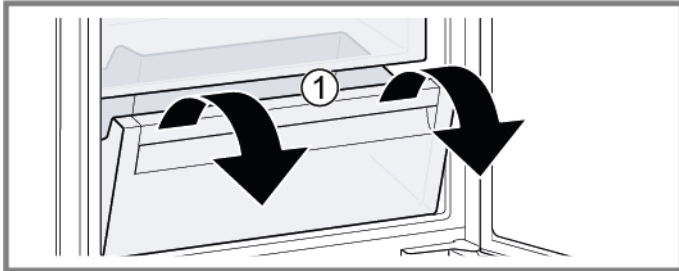

➡ Cool-Fresh-beholderen er demontert.

### 4.11.2 Montering av Cool-Fresh-beholder

- ▶ Monteres i motsatt rekkefølge.

## 4.12 Utskiftning av uttrekkbar beholder

### Forutsetning:

- ✔ Døren er åpen.

### 4.12.1 Demontering av uttrekkbar beholder

- ▶ 1. Vipp den uttrekkbare beholderen forover (1).
- ▶ 2. Ta ut den uttrekkbare beholderen (2).

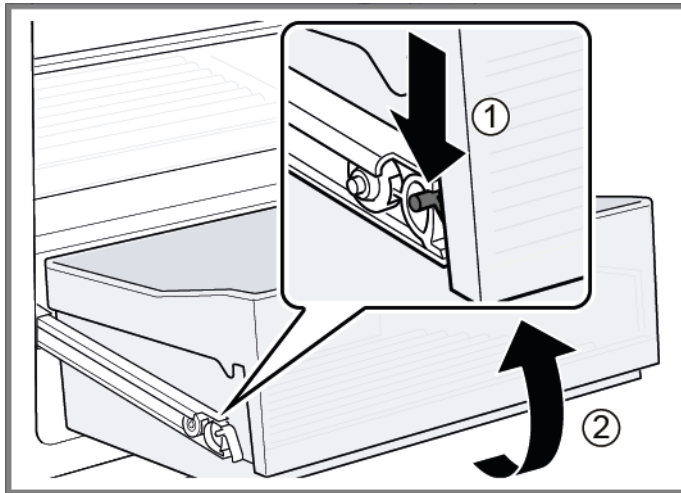

➡ Den uttrekkbare beholderen er demontert.

### 4.12.2 Montering av uttrekkbar beholder

- ▶ Monteres i motsatt rekkefølge.

## 4.13 Utskiftning av LED-spotlight

### Spesielle hjelpemidler:

- Spesialverktøy [00342180]
- Flat skrutrekker Blad 2,4 mm x 0,4 mm x 60 mm, i sett [00341820]

**i** Apparatet har en vedlikeholdsfri LED-lampe. Disse lampene skal kun repareres av kundeservice eller autoriserte teknikere!

**FARE**  
**Fare for elektrisk støt på grunn av strømførende deler!**  
Livsfare på grunn av elektrisk støt ved feil reparasjon

- Elektriske deler skal repareres av kvalifiserte elektrikere.
- Etter reparasjonen må du sørge for at det utføres en sikkerhets-test iht. VDE 0701 eller gjeldende forskrifter i det respektive land.

**FARE**  
**Fare for elektrisk støt på grunn av strømførende deler!**  
Død på grunn av drepende elektrisk støt

- Koble apparatene fra strømforsyningen i minst 60 sekunder før reparasjonene startes.

**FORSIKTIG**  
**Skarpe kanter!**  
Kuttskader

- Bruk vernehansker.

### Forutsetning:

- Apparatet kobles fra strømforsyningen.
- Døren er åpen.
- Hyllene i fryseren er tatt ut.

## 4.13.1 Demontering av LED-spotlight

- Løsne LED-spotlightdekslet.

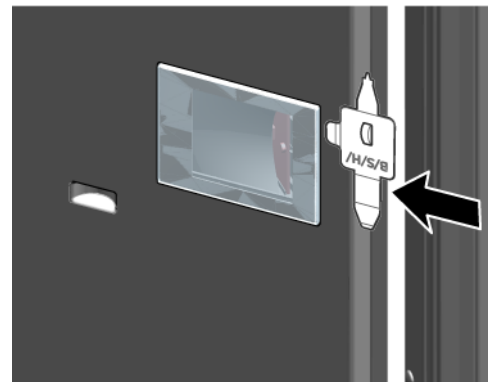

- Trekk LED-spotlightdekslet innover og skyv det samtidig forover.

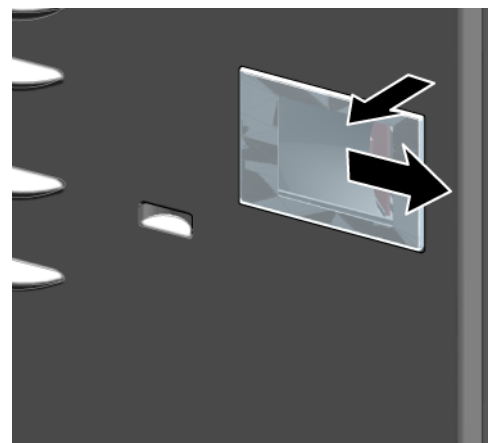



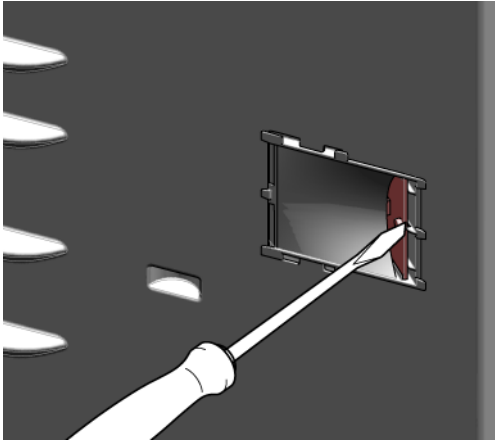

## Reparasjon

3. Løsne LED -spotlightmodulen.

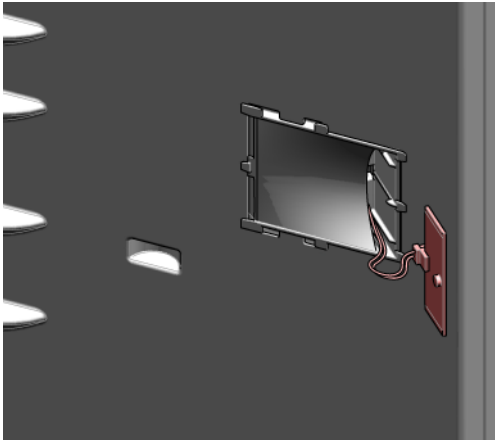

4. Koble fra den elektriske tilkoblingen for LED-spotlight.







 LED-spotlight er demontert.

### 4.13.2 Montering av LED-spotlight

▶ Monteres i motsatt rekkefølge.

# Wskazówki naprawy - Chłodziarko-zamrażarka

 <b>Informacje dotyczące dokumentu</b> .....	<b>387</b>
1.1 Ważne informacje.....	387
1.1.1 Cel dokumentu .....	387
1.2 Objaśnienie symboli ostrzegawczych.....	387
1.2.1 Oznaczenie poziomów niebezpieczeństwa .....	387
1.2.2 Symbole ostrzegawcze.....	387
1.2.3 Budowa ostrzeżeń .....	388
1.2.4 Ogólne symbole.....	388
 <b>Bezpieczeństwo</b> .....	<b>389</b>
2.1 Ogólne informacje dotyczące bezpieczeństwa.....	389
2.1.1 Wszystkie sprzęty gospodarstwa domowego .....	389
 <b>Narzędzia i pomoce techniczne</b> .....	<b>390</b>
 <b>Naprawy</b> .....	<b>391</b>
4.1 Wymiana uszczelki drzwiczek .....	391
4.1.1 Demontaż uszczelki drzwiczek.....	391
4.1.2 Montaż uszczelki drzwiczek.....	391
4.2 Wymiana zawiasu płaskiego .....	394
4.2.1 Demontaż zawiasu płaskiego.....	394
4.2.2 Montaż zawiasu płaskiego.....	396
4.3 Wymiana zawiasu suwakowego .....	397
4.3.1 Demontaż zawiasu suwakowego .....	397
4.3.2 Montaż zawiasu suwakowego.....	398
4.4 Wymiana półki drzwiczek .....	399
4.4.1 Demontaż półki drzwiczek .....	399
4.4.2 Montaż półki drzwiczek.....	399
4.5 Wymiana półki .....	400
4.5.1 Demontaż półki .....	400
4.5.2 Montaż półki .....	400
4.6 Wymiana półki wysuwanej .....	401
4.6.1 Demontaż półki wysuwanej.....	401
4.6.2 Montaż półki wysuwanej.....	401
4.7 Wymiana półki komory zamrażarki.....	402
4.7.1 Demontaż półki komory zamrażarki.....	402
4.7.2 Montaż półki komory zamrażarki .....	402
4.8 Wymiana pojemnika na mrożoną żywność .....	403
4.8.1 Demontaż pojemnika na mrożoną żywność.....	403
4.8.2 Montaż pojemnika na mrożoną żywność.....	403
4.9 Wymiana pojemnika na owoce i warzywa .....	404
4.9.1 Demontaż pojemnika na owoce i warzywa .....	404
4.9.2 Montaż pojemnika na owoce i warzywa .....	404
4.10 Wymiana przegródki i pokrywy pojemnika na owoce i warzywa .....	405
4.10.1 Demontaż przegródki i pokrywy pojemnika na owoce i warzywa.....	405
4.10.2 Montaż przegródki i pokrywy pojemnika na owoce i warzywa.....	405
4.11 Wymiana pojemnika chłodzącego na świeże artykuły.....	406
4.11.1 Demontaż pojemnika chłodzącego na świeże artykuły .....	406
4.11.2 Montaż pojemnika chłodzącego na świeże artykuły .....	406
4.12 Wymiana pojemnika wysuwanego.....	407
4.12.1 Demontaż pojemnika wysuwanego.....	407
4.12.2 Montaż pojemnika wysuwanego .....	407
4.13 Wymiana oświetlenia punktowego LED .....	408
4.13.1 Demontaż oświetlenia punktowego LED .....	408
4.13.2 Montaż oświetlenia punktowego LED.....	409

# **i** Informacje dotyczące dokumentu

## 1.1 Ważne informacje

### 1.1.1 Cel dokumentu

Niniejsze wskazówki naprawcze mają na celu zapewnienie użytkownikowi pomocy w samodzielnej naprawie posiadanych urządzeń w sposób zgodny z obowiązującymi przepisami w sprawie ekoprojektu (stan na 03/2021).

Zawierają one informacje na temat wymiany określonych części zamiennych oraz ostrzeżenia i informacje o zagrożeniach.

W razie pytań należy się skontaktować z naszym działem serwisowym. Odpowiedzialność za szkody ponosimy tylko pod warunkiem prawidłowego stosowania się do wskazówek naprawczych.

## 1.2 Objasnienie symboli ostrzegawczych

### 1.2.1 Oznaczenie poziomów niebezpieczeństwa

Poziom ryzyka jest określany przy pomocy symbolu oraz wyrazu. Wyraz określa poziom ryzyka.



Symbol	Znaczenie
 <b>NIEBEZPIECZEŃSTWO</b>	Bezpośrednio zagrażające niebezpieczeństwo, które przy niezachowaniu odpowiednich środków ostrożności może doprowadzić do śmierci lub poważnych obrażeń.
 <b>OSTRZEŻENIE</b>	Prawdopodobieństwo wystąpienia niebezpieczeństwa, które przy niezachowaniu odpowiednich środków ostrożności może doprowadzić do śmierci lub poważnych obrażeń.
 <b>WAŻNE</b>	Prawdopodobieństwo wystąpienia niebezpieczeństwa, które przy niezachowaniu odpowiednich środków ostrożności może doprowadzić do powstania lekkich obrażeń.
<b>UWAGA!</b>	Ostrzeżenie dot. możliwości powstania szkody materialnej.

Tabela 1: Oznaczenie poziomów niebezpieczeństwa

### 1.2.2 Symbole ostrzegawcze

Symbole ostrzegawcze reprezentują graficznie źródło potencjalnego ryzyka.

W poniższym dokumencie użyto następujących symboli:

Symbole ostrzegawcze	Znaczenie
	Ogólne ostrzeżenie
	Niebezpieczeństwo od napięcia elektrycznego
	Ryzyko wybuchu

## **i** Informacje dotyczące dokumentu







Symbole ostrzegawcze	Znaczenie
	Ryzyko obrażeń (rozcięć)
	Ryzyko zmiążdżenia
	Ryzyko oparzenia
	Silne pole magnetyczne
	Promieniowanie nie-jonizujące

Tabela 2: Symbole ostrzegawcze

### 1.2.3 Budowa ostrzeżeń

Ostrzeżenia podane w dokumencie mają standardową budowę.

	<p><b>⚠ NIEBEZPIECZEŃSTWO</b></p> <p><b>Typ i źródło ryzyka!!</b>            Konsekwencje zignorowania.            ▶ Środki ochronne.</p>
---	---

Kolejne ostrzeżenie wskazuje, jako źródło możliwość porażenia prądem. Wskazano czynności, które mają za zadanie ograniczenie ryzyka.

	<p><b>⚠ NIEBEZPIECZEŃSTWO</b></p> <p><b>Ryzyko porażenia prądem, ze względu na elementy będące pod napięciem!</b>            Zagrożenie życia poprzez porażenie prądem            ▶ Odłączyć urządzenie od zasilania sieciowego na 60 sekund przed rozpoczęciem naprawy.</p>
--	--

### 1.2.4 Ogólne symbole

Poniższe symbole są używane w dokumentacji:







Symbol	Znaczenie
	Identyfikacja specjalnej wskazówki (tekst lub grafika)
	Identyfikacja prostej wskazówki (tylko tekst)
	Identyfikacja linku do pliku wideo
	Identyfikacja narzędzi
	Identyfikacja wstępnych warunków
	Identyfikacja warunku (jeżeli)
	Identyfikacja rezultatu
[Start]	Identyfikacja przycisku
[00123456]	Identyfikacja numeru materiału
Status	Identyfikacja wyświetlanego tekstu / komunikatu (na wyświetlaczu)

Tabela 3: Ogólne symbole

## **2.1 Ogólne informacje dotyczące bezpieczeństwa**

### **2.1.1 Wszystkie sprzęty gospodarstwa domowego**

#### **Ryzyko porażenia prądem elektrycznym wskutek kontaktu z elementami znajdującymi się pod napięciem!**

- Błędna naprawa części elektrycznych może spowodować porażenie prądem elektrycznym!
- Co najmniej 60 sekund przed przystąpieniem do pracy odłączyć urządzenie od sieci elektrycznej.
- Po naprawie należy przeprowadzić test bezpieczeństwa zgodny z przepisami normy VDE 0701 (Niemcy) lub odpowiednimi przepisami obowiązującymi w kraju użytkowania.

#### **Ryzyko zranienia o ostre krawędzie!**

- Używać rękawic ochronnych.

#### **Ryzyko zmiążdżenia podczas naprawy, obsługi lub diagnozy, ze względu na ciężkie i ruchome elementy**

- Stosować obuwie ochronne.
- Zabezpieczyć ciężkie elementy przed upadkiem.
- Nie dotykać ruchomych elementów podczas pracy urządzenia.



#### **Zagrożenie dla bezpieczeństwa użytkownika i działania urządzenia!**

- Używać tylko oryginalnych części zamiennych.

#### **Ryzyko uszkodzenia komponentów wrażliwych na wyładowania elektrostatyczne (ESD)!**

- Nie dotykać modułów, włącznie ze złączami i ścieżkami przewodzącymi.

## Narzędzia i pomoce techniczne

Przeznaczenie	Detale	Zdjęcia
Tkanina ochronna [00342013]	60 cm x 50 cm	
Torx Bit TX20 [00340865]	6,3 mm (1/4")	
Narzędzie specjalne [00342180]		

## 4.1 Wymiana uszczelki drzwiczek

### Warunek:

- ✔ Drzwiczki są otwarte.

### 4.1.1 Demontaż uszczelki drzwiczek

1. Poluzować uszczelkę drzwiczek w rowku w prawym i lewym narożniku.

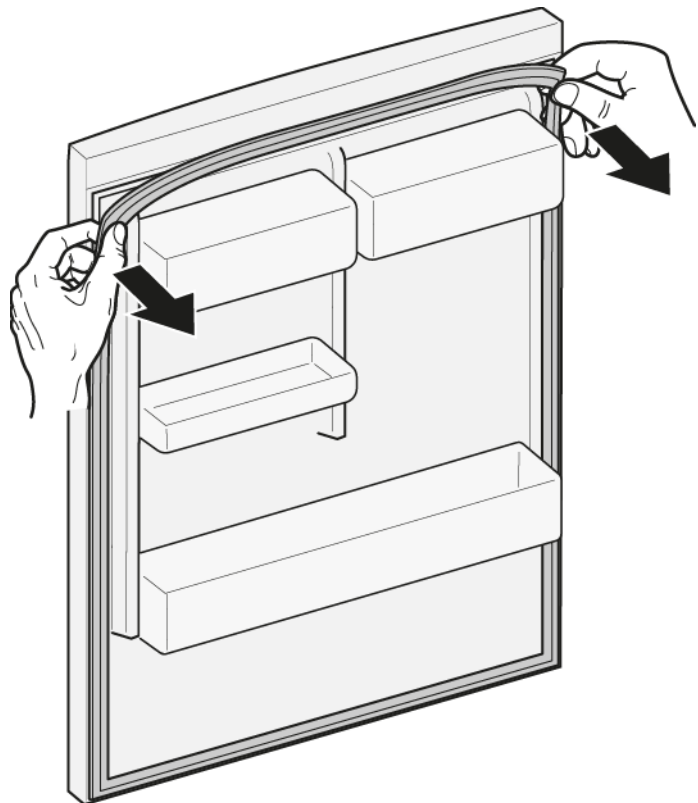

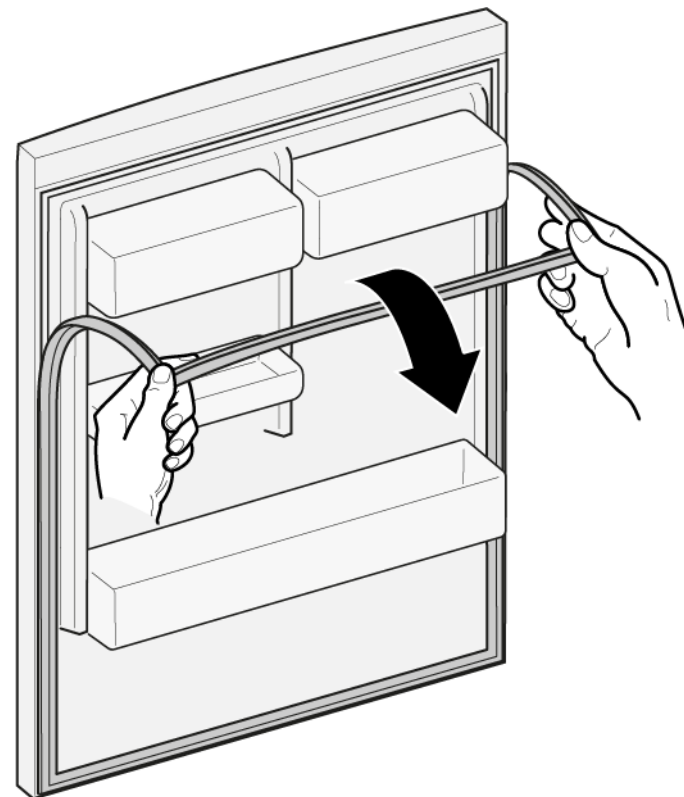

2. Wyciągnąć uszczelkę drzwiczek z rowka.



- ➡ Uszczelka drzwiczek została zdemontowana.

### 4.1.2 Montaż uszczelki drzwiczek

	Grubość nowej uszczelki drzwiczek może się nieco różnić od grubości starej uszczelki drzwiczek. Nie ma to wpływu na jakość zamykania drzwiczek i i działanie urządzenia.
	Jeżeli urządzenie posiada regulowane zawiasy lub elementy mocujące zawiasów, można przy ich użyciu regulować sposób zamykania drzwiczek.
	Małe boczne otwory w uszczelce drzwiczek są elementami funkcyjnymi (zapewniają wentylację). Nie stanowią one wad produkcyjnych.

1. Skontrolować rowek uszczelki pod kątem uszkodzeń.

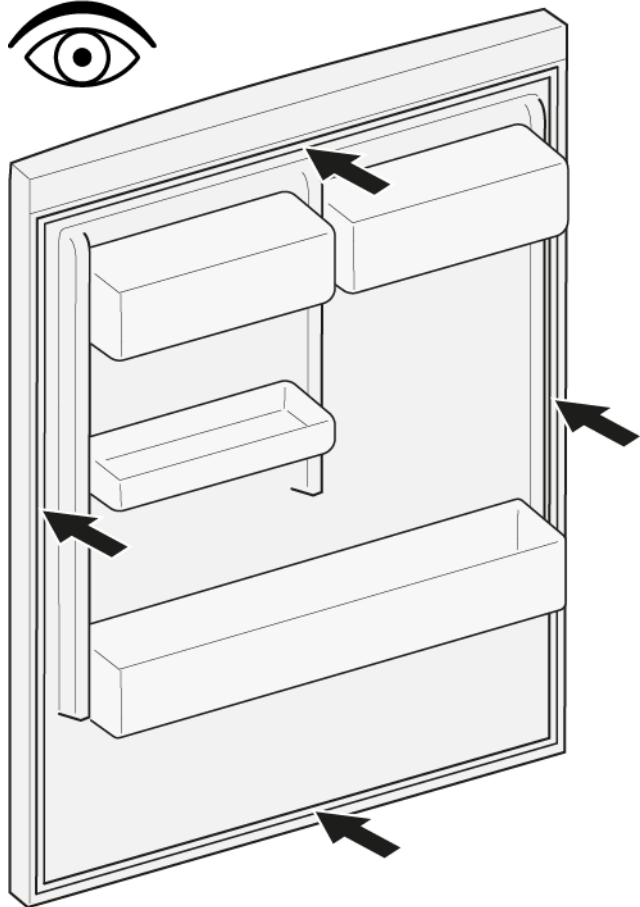

4. Wcisnąć narożniki uszczelki do rowka u dołu i u góry.

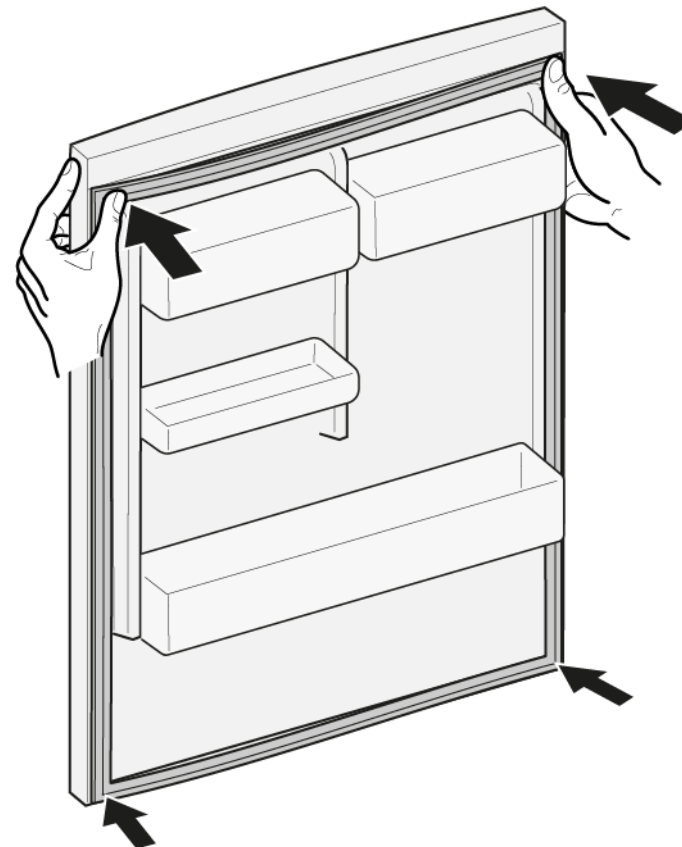

2.  Jeżeli rowek uszczelki jest uszkodzony.  
- Skontaktować się z serwisem.

3.  Lekka deformacja uszczelki drzwiczek jest normalna i nie wpływa na jej funkcję. Zaleca się wyprostowanie uszczelki drzwiczek przed jej zamocowaniem w urządzeniu.

Ogrzać uszczelkę drzwiczek suszarką do włosów lub nadać jej żądany kształt rękami.



5. Krok po kroku wcisnąć uszczelkę do rowka na całym obwodzie.

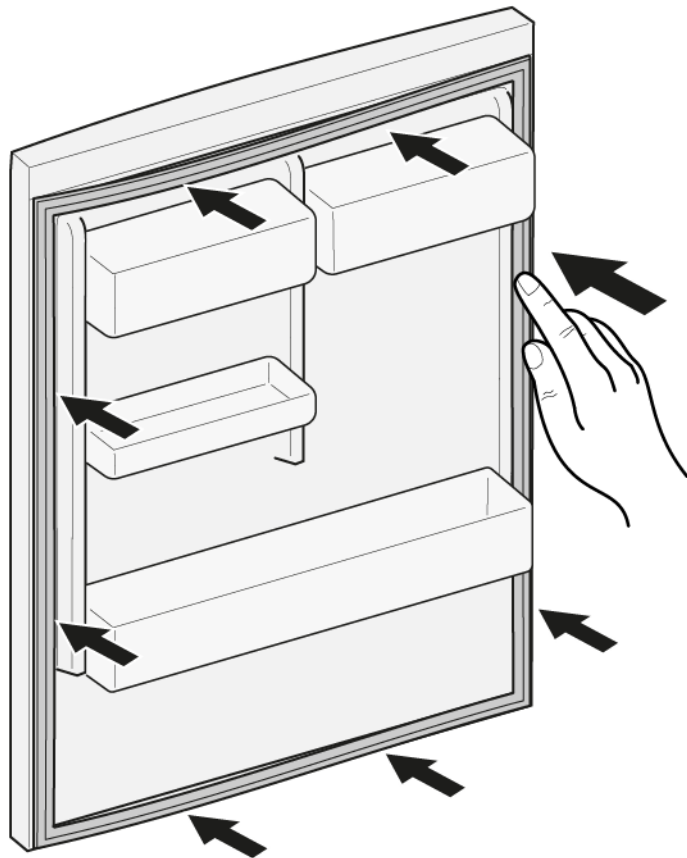

 Uszczelka drzwiczek została zamontowana.

## 4.2 Wymiana zawiasu płaskiego

### Pomoce specjalne

Torx Bit TX20

6,3 mm (1/4")

[00340865]



#### OSTRZEŻENIE

##### Ciężkie, nieporęczne urządzenia!

Kontuzje mięśni i pleców

- ▶ Czynność demontażu drzwiczek urządzenia powinna być wykonywana tylko przez wyszkolonych techników.
- ▶ Przemieszczenie urządzenia wymaga udziału dwóch osób.
- ▶ Używać tylko odpowiednich narzędzi i sprzętu.



#### WAŻNE

##### Ostre krawędzie!

Rany cięte

- ▶ Zawsze używaj rękawic ochronnych.



#### WAŻNE

##### Odslonięty zawias!

Zmiażdżenie / uwięzienie palca

- ▶ Nie wkładać rąk pod zawiasy.
- ▶ Zawsze używaj rękawic ochronnych.



#### WAŻNE

##### Niebezpieczeństwo spadnięcia części po wykręceniu śrub!

Zranienie przez spadające części.

- ▶ Zabezpieczyć część przed spadnięciem.



#### UWAGA!

##### Niebezpieczeństwo spadnięcia części po wykręceniu śrub!

Uszkodzenie innych części urządzenia albo pomieszczenia mieszkalnego, np. podłogi.

- ▶ Zabezpieczyć część przed spadnięciem.

### Warunek:

- ✔ Urządzenie jest odłączone od źródła zasilania energią elektryczną.
- ✔ Zostały wymontowane drzwiczki mebla. Patrz instrukcja montażu.
- ✔ Drzwiczki są otwarte.

## 4.2.1 Demontaż zawiasu płaskiego

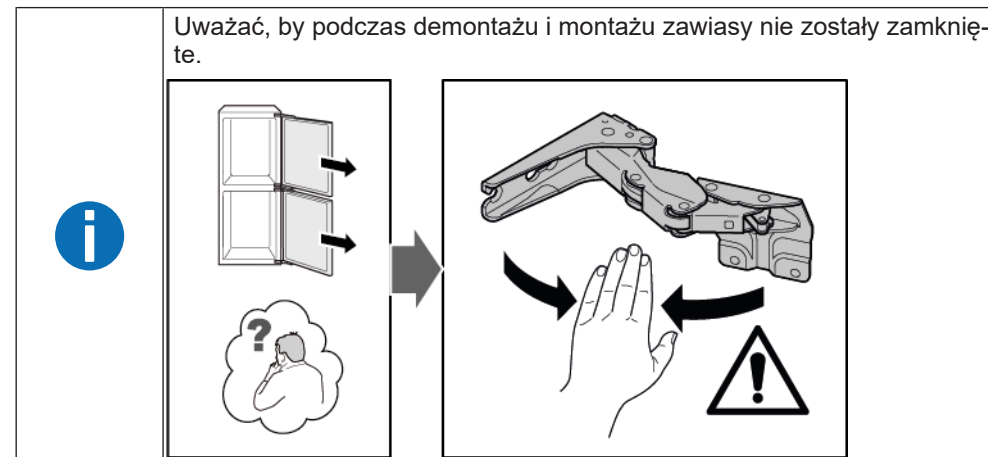

1. Wyjąć cztery osłony zawiasów.

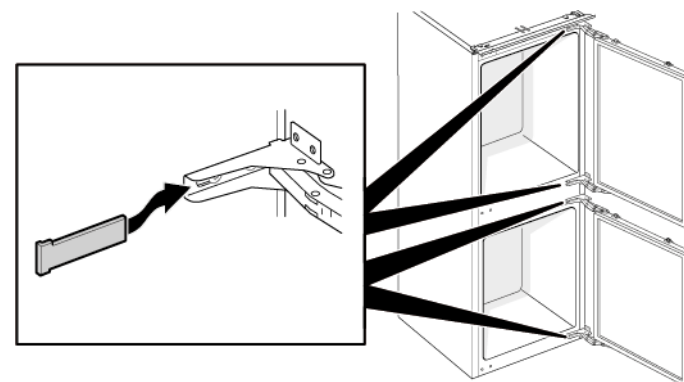

## Naprawy

2. 1. Poluzować cztery śruby (1).  
2. Wysunąć i wyjąć drzwiczki górne (2).

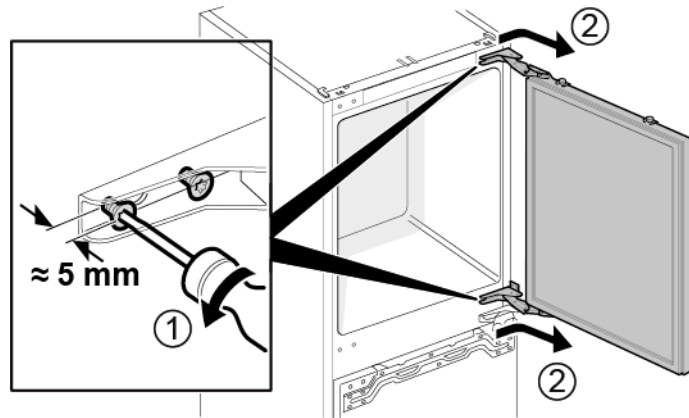

3. 1. Wykręcić cztery śruby (1).  
2. Wyjąć zawiasy (2).

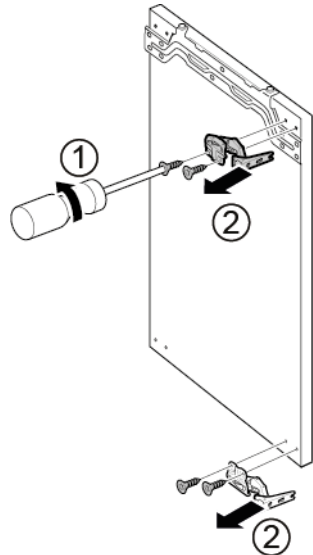

➡ Zawiasy górnych drzwiczek są wymontowane.

4. 1. Poluzować cztery śruby (1).  
2. Wysunąć i wyjąć dolne drzwiczki (2).

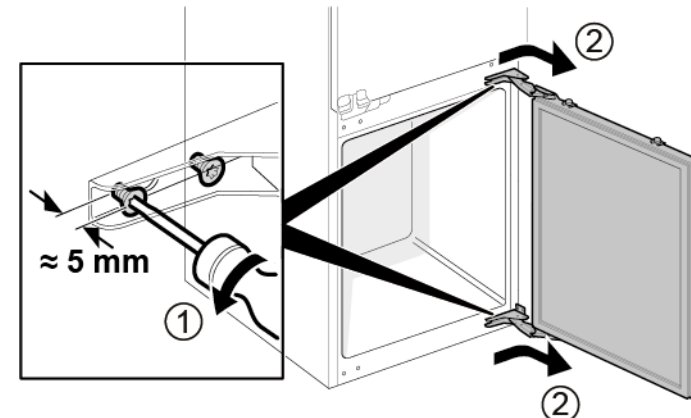

5. 1. Wykręcić cztery śruby (1).  
2. Wyjąć zawiasy (2).

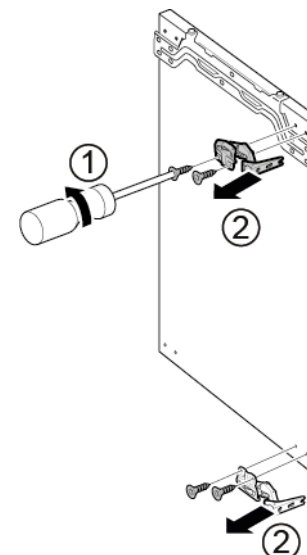

➡ Zawiasy dolnych drzwiczek są wymontowane.

### 4.2.2 Montaż zawiasu płaskiego

- ▶ Montaż w odwrotnej kolejności.

## 4.3 Wymiana zawiasu suwakowego

### Pomoce specjalne

Torx Bit TX20 6,3 mm (1/4") [00340865]

	<b>⚠ OSTRZEŻENIE</b>
	<p><b>Ciężkie, nieporęczne urządzenia!</b> Kontuzje mięśni i pleców</p> <ul style="list-style-type: none"> <li>▶ Czynność demontażu drzwiczek urządzenia powinna być wykonywana tylko przez wyszkolonych techników.</li> <li>▶ Przemieszczenie urządzenia wymaga udziału dwóch osób.</li> <li>▶ Używać tylko odpowiednich narzędzi i sprzętu.</li> </ul>

	<b>⚠ WAŻNE</b>
	<p><b>Ostre krawędzie!</b> Rany cięte</p> <ul style="list-style-type: none"> <li>▶ Zawsze używaj rękawic ochronnych.</li> </ul>

	<b>⚠ WAŻNE</b>
	<p><b>Niebezpieczeństwo spadnięcia części po wykręceniu śrub!</b> Zranienie przez spadające części.</p> <ul style="list-style-type: none"> <li>▶ Zabezpieczyć część przed spadnięciem.</li> </ul>

	<b>UWAGA!</b>
	<p><b>Niebezpieczeństwo spadnięcia części po wykręceniu śrub!</b> Uszkodzenie innych części urządzenia albo pomieszczenia mieszkalnego, np. podłogi.</p> <ul style="list-style-type: none"> <li>▶ Zabezpieczyć część przed spadnięciem.</li> </ul>

### Warunek:

- ✔ Urządzenie jest odłączone od źródła zasilania energią elektryczną.
- ✔ Drzwiczki mebla zostały odłączone od drzwiczek urządzenia. Patrz instrukcja montażu.

### 4.3.1 Demontaż zawiasu suwakowego

1. Wykręcić dwie śruby (1).
2. Wyjąć zawias górny drzwiczek górnych (2).
3. Wyjąć drzwiczki górne (3).
4. Wykręcić dwie śruby (4).
5. Wyjąć zawias górny drzwiczek dolnych (5).
6. Wyjąć drzwiczki dolne (6).

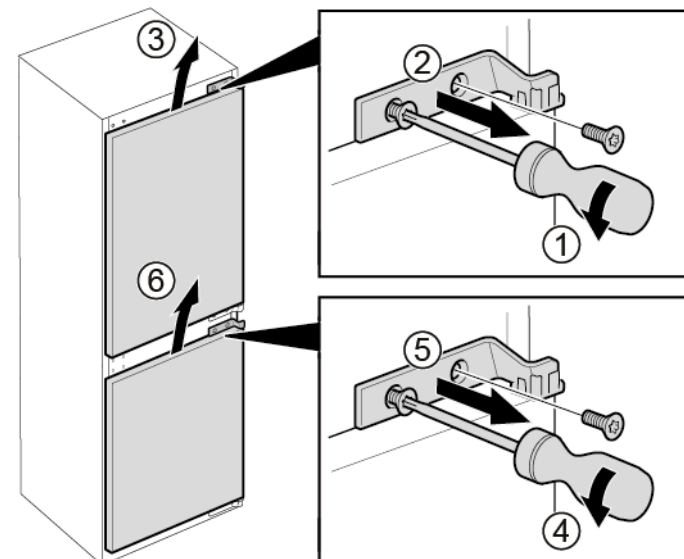

2. 1. Wykręcić cztery śruby (1).
2. Wyjąć zawiasy dolne (2).

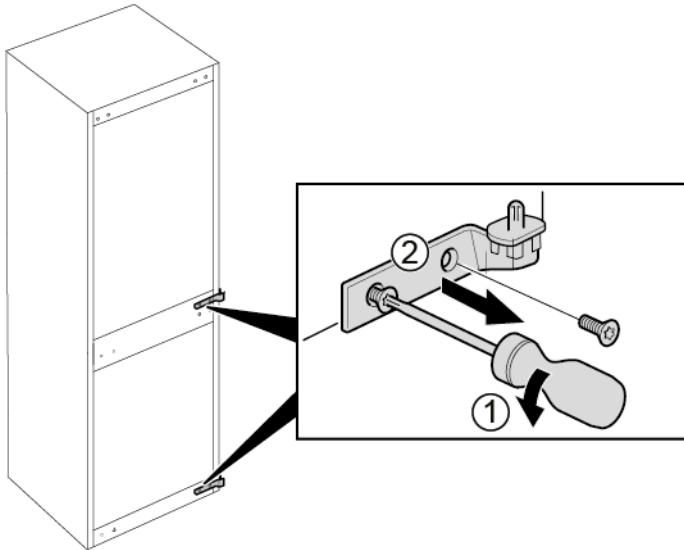

 Zawiasy są wymontowane.

### 4.3.2 Montaż zawiasu suwakowego

- ▶ Montaż w odwrotnej kolejności.

## 4.4 Wymiana półki drzwiczek

### Warunek:

- ✔ Drzwiczki są otwarte.

### 4.4.1 Demontaż półki drzwiczek

- ▶ Podnieść półkę drzwiczek do góry.

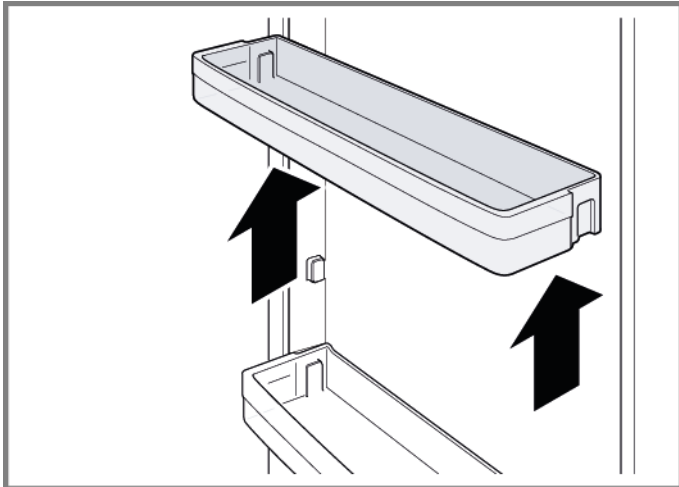

- ➡ Półka drzwiczek została zdemontowana.

### 4.4.2 Montaż półki drzwiczek

- ▶ Montaż w odwrotnej kolejności.

## 4.5 Wymiana półki

### Warunek:

- ✔ Drzwiczki są otwarte.

### 4.5.1 Demontaż półki

- ▶ Wyciągnąć półkę.

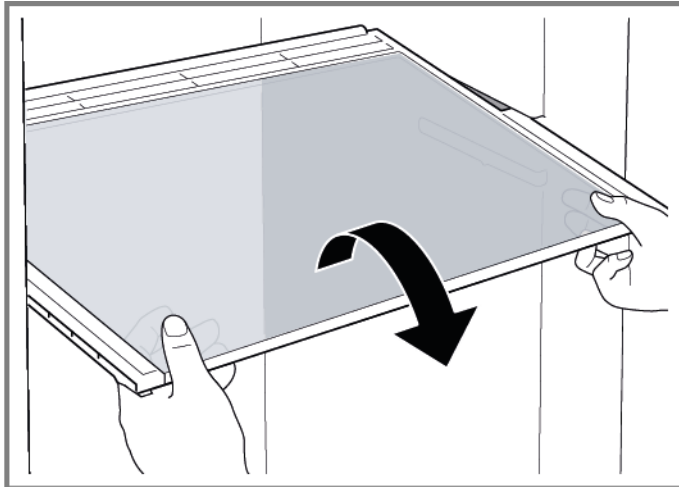

- ➡ Półka jest wyjęta.

### 4.5.2 Montaż półki

- ▶ Montaż w odwrotnej kolejności.



## 4.6 Wymiana półki wysuwanej

### Warunek:

- ✔ Drzwiczki są otwarte.

### 4.6.1 Demontaż półki wysuwanej

1. Wyciągać półkę wysuwaną do momentu odblokowania mechanizmu zatrzaskowego.

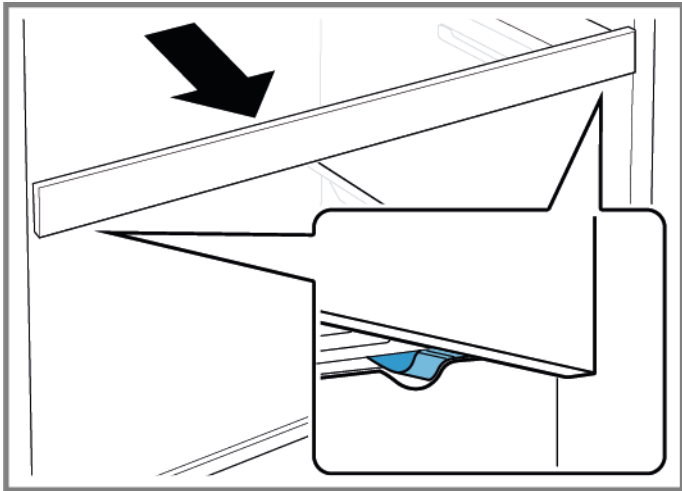

2. Opuścić półkę wysuwaną i przechylić ją na bok.
3. ➡ Półka wysuwana została wyjęta.

### 4.6.2 Montaż półki wysuwanej

- ▶ Montaż w odwrotnej kolejności.

## 4.7 Wymiana półki komory zamrażarki

### Warunek:

- ✔ Drzwiczki są otwarte.

### 4.7.1 Demontaż półki komory zamrażarki

- ▶ Wyciągnąć półkę komory zamrażarki.

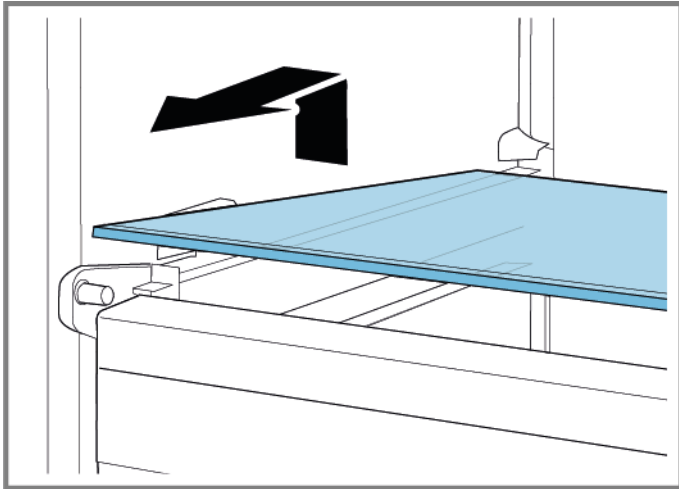

- ➡ Półka komory zamrażarki została wyjęta.

### 4.7.2 Montaż półki komory zamrażarki

- ▶ Montaż w odwrotnej kolejności.

## 4.8 Wymiana pojemnika na mrożoną żywność

### Warunek:

- ✔ Drzwiczki są otwarte.

### 4.8.1 Demontaż pojemnika na mrożoną żywność

- ▶ 1. Wyciągnąć pojemnik na mrożoną żywność do końca (1).
- ▶ 2. Wyjąć pojemnik na mrożoną żywność (2).

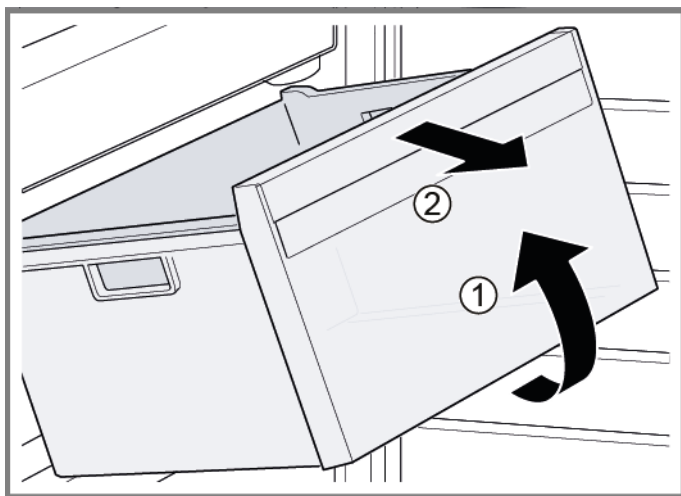

- ➡ Pojemnik na mrożoną żywność został wyjęty.

### 4.8.2 Montaż pojemnika na mrożoną żywność

- ▶ Montaż w odwrotnej kolejności.

## 4.9 Wymiana pojemnika na owoce i warzywa

### Warunek:

- ✔ Drzwiczki są otwarte.

### 4.9.1 Demontaż pojemnika na owoce i warzywa

- ▶ 1. Wyciągnąć pojemnik do końca (1).
- ▶ 2. Wyjąć pojemnik (2).

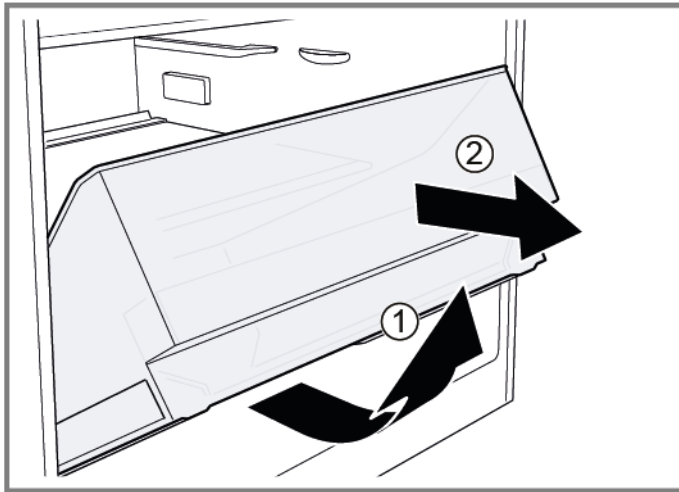

- ➡ Pojemnik został wyjęty.

### 4.9.2 Montaż pojemnika na owoce i warzywa

- ▶ Montaż w odwrotnej kolejności.

## 4.10 Wymiana przegródki i pokrywy pojemnika na owoce i warzywa

### Warunek:

- ✔ Drzwiczki są otwarte.

### 4.10.1 Demontaż przegródki i pokrywy pojemnika na owoce i warzywa

1. Wyjąć płytę szklaną z przegródki.

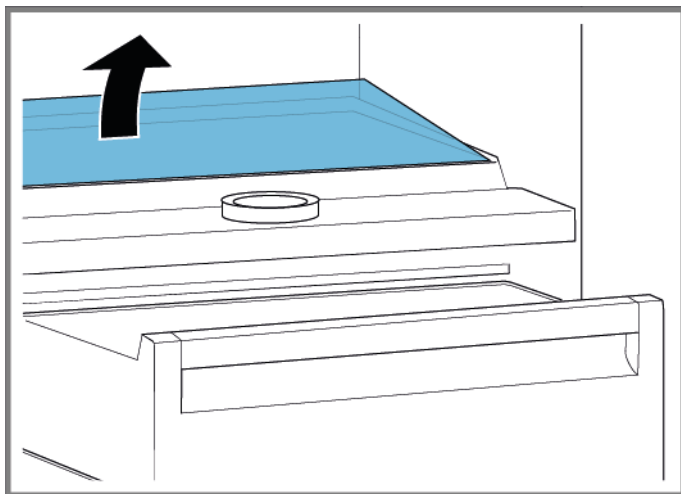

2. [Wyjąć pojemnik na owoce i warzywa. →404](#)

3. 1. Wcisnąć dźwignienki na spodniej stronie po obu stronach przegródki (1).
2. Pociągnąć przegródkę do przodu (2).

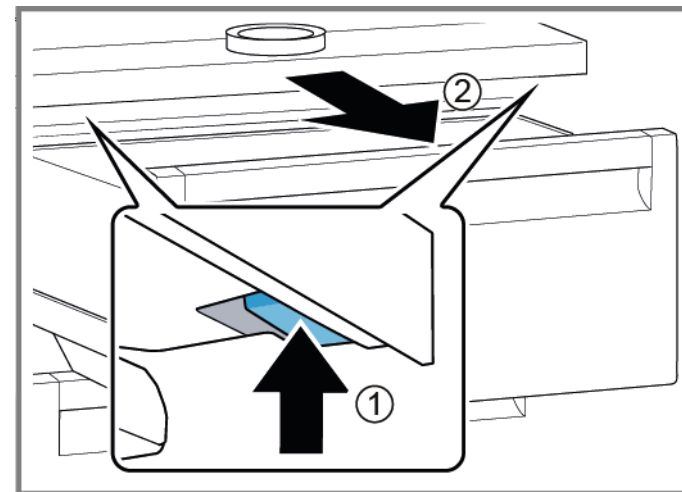

4. Podnieść przegródkę i obracając wyjąć ją z boku.  
➡ Przegródka jest wyjęta.
5. 1. Podnieść pokrywę pojemnika na owoce i warzywa.  
2. Pociągnąć pokrywę pojemnika na owoce i warzywa do przodu i obracając wyjąć ją z boku.  
➡ Pokrywa pojemnika na owoce i warzywa jest wyjęta.

### 4.10.2 Montaż przegródki i pokrywy pojemnika na owoce i warzywa

- ▶ Montaż w odwrotnej kolejności.

## 4.11 Wymiana pojemnika chłodzącego na świeże artykuły

### Warunek:

- ✔ Drzwiczki są otwarte.

### 4.11.1 Demontaż pojemnika chłodzącego na świeże artykuły

- ▶ 1. Przechylić pojemnik chłodzący na świeże artykuły do przodu (1).
- ▶ 2. Wyjąć pojemnik chłodzący na świeże artykuły (2).

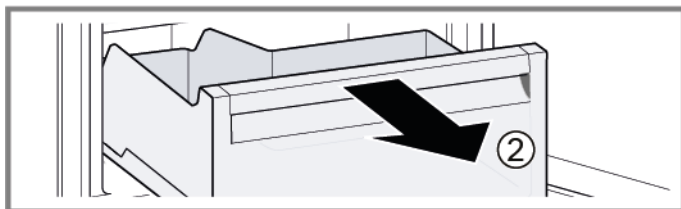
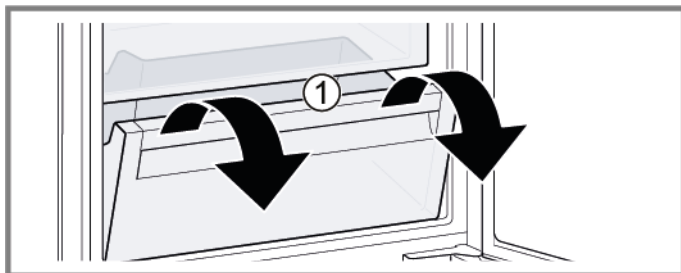

- ➡ Pojemnik chłodzący na świeże artykuły został wyjęty.

### 4.11.2 Montaż pojemnika chłodzącego na świeże artykuły

- ▶ Montaż w odwrotnej kolejności.

## 4.12 Wymiana pojemnika wysuwanego

### Warunek:

- ✔ Drzwiczki są otwarte.

### 4.12.1 Demontaż pojemnika wysuwanego

- ▶ 1. Przechylić pojemnik wysuwany do przodu (1).
- ▶ 2. Wyjąć pojemnik wysuwany (2).

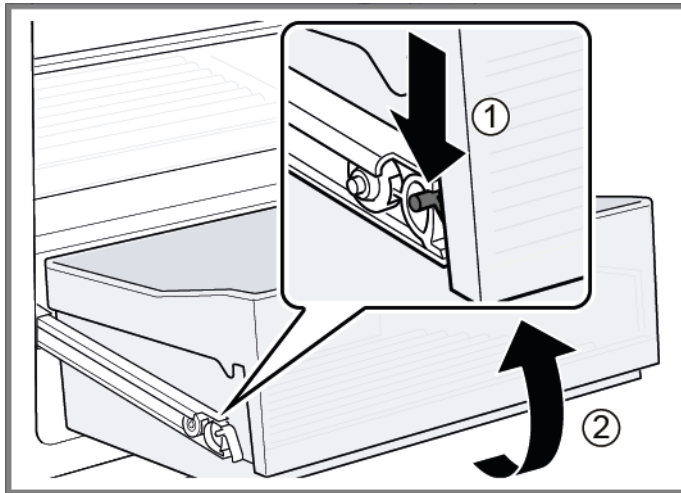

- ➡ Pojemnik wysuwany został wyjęty.

### 4.12.2 Montaż pojemnika wysuwanego

- ▶ Montaż w odwrotnej kolejności.

## 4.13 Wymiana oświetlenia punktowego LED

### Pomoce specjalne

- 🔧 Narzędzie specjalne [00342180]
- 🔧 Śrubokręt z końcówką płaską Kończówka 2,4 mm x 0,4 mm x 60 mm, w zestawie [00341820]

**i** Urządzenie posiada bezobsługowe oświetlenie LED. Tego rodzaju elementy oświetleniowe mogą być naprawiane wyłącznie przez serwis lub autoryzowanych techników!

**⚠ NIEBEZPIECZEŃSTWO**  
**Ryzyko porażenia prądem elektrycznym wskutek kontaktu z elementami znajdującymi się pod napięciem!**  
 Niebezpieczeństwo utraty życia wskutek porażenia prądem elektrycznym w przypadku nieprawidłowej naprawy

- ▶ Części elektryczne powinny być naprawiane przez wykwalifikowanych elektryków.
- ▶ Po naprawie należy przeprowadzić test bezpieczeństwa zgodny z przepisami normy VDE 0701 (Niemcy) lub odpowiednimi przepisami obowiązującymi w kraju użytkownika.

**⚠ NIEBEZPIECZEŃSTWO**  
**Ryzyko porażenia prądem, ze względu na elementy będące pod napięciem!**  
 Zagrożenie życia poprzez porażenie prądem

- ▶ Odłączyć urządzenie od zasilania sieciowego na 60 sekund przed rozpoczęciem naprawy.

**⚠ WAŻNE**  
**Ostre krawędzie!**  
 Rany cięte

- ▶ Zawsze używaj rękawic ochronnych.

### Warunek:

- ✔ Urządzenie jest odłączone od źródła zasilania energią elektryczną.
- ✔ Drzwiczki są otwarte.
- ✔ Z komory chłodziarki zostały wyjęte półki.

### 4.13.1 Demontaż oświetlenia punktowego LED

1. Odblokować pokrywę oświetlenia punktowego LED.

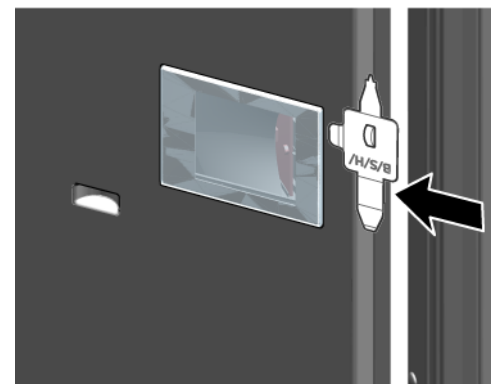

2. Pociągnąć pokrywę oświetlenia punktowego LED do wewnątrz, jednocześnie pochylając ją do przodu.

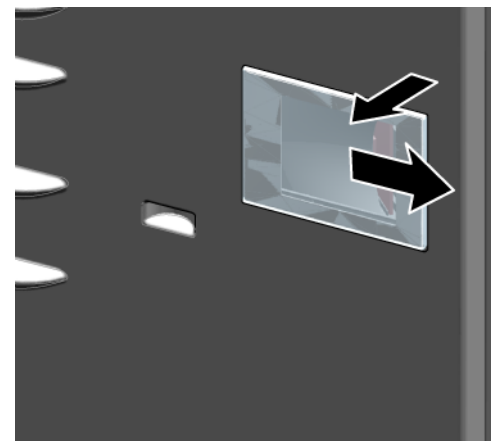



3. Odłączyć moduł oświetlenia punktowego LED.

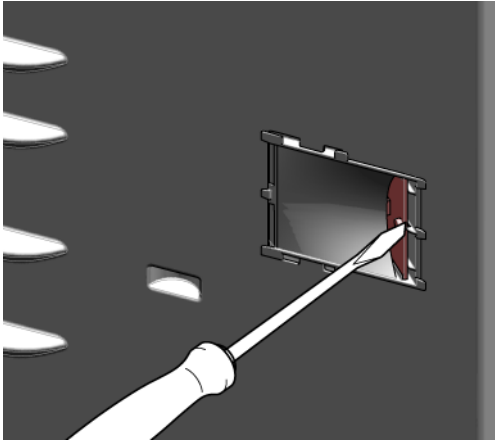

4. Rozłączyć złącze elektryczne oświetlenia punktowego LED.

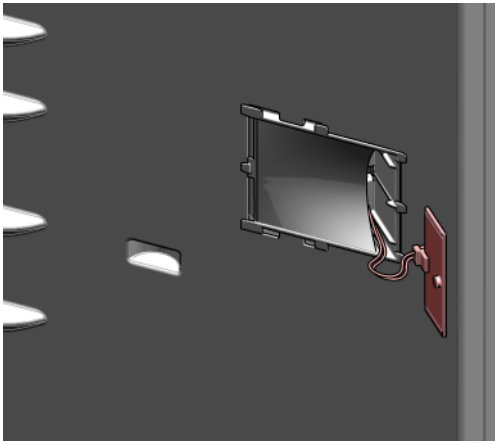





- ➡ Oświetlenie punktowe LED zostało wymontowane.

### 4.13.2 Montaż oświetlenia punktowego LED

- ▶ Montaż w odwrotnej kolejności.

# Dicas de resolução - Combinado de refrigeração/congelação

 <b>Sobre este documento</b> .....	<b>411</b>
1.1 Informação importante .....	411
1.1.1 Finalidade.....	411
1.2 Explicação dos símbolos.....	411
1.2.1 Níveis de perigo.....	411
1.2.2 Símbolos de perigo .....	411
1.2.3 Estrutura dos avisos.....	412
1.2.4 Símbolos gerais .....	412
 <b>Segurança</b> .....	<b>413</b>
2.1 Instruções gerais de segurança.....	413
2.1.1 Todos os eletrodomésticos .....	413
 <b>Ferramentas e auxiliares</b> .....	<b>414</b>
 <b>Reparação</b> .....	<b>415</b>
4.1 Substituir a junta da porta .....	415
4.1.1 Remover a junta da porta .....	415
4.1.2 Instalar a junta da porta.....	415
4.2 Substituir a dobradiça plana .....	418
4.2.1 Remover a dobradiça plana.....	418
4.2.2 Instalar a dobradiça plana .....	420
4.3 Substituir a dobradiça deslizante .....	421
4.3.1 Remover a dobradiça deslizante .....	421
4.3.2 Instalar a dobradiça deslizante.....	422
4.4 Substituir a prateleira da porta.....	423
4.4.1 Remover a prateleira da porta.....	423
4.4.2 Instalar a prateleira da porta .....	423
4.5 Substituir a prateleira .....	424
4.5.1 Remover a prateleira.....	424
4.5.2 Instalar a prateleira .....	424
4.6 Substituir a prateleira extensível.....	425
4.6.1 Remover a prateleira extensível.....	425
4.6.2 Instalar a prateleira extensível .....	425
4.7 Substituir a prateleira da zona do congelador.....	426
4.7.1 Remover a prateleira da zona do congelador.....	426
4.7.2 Instalar a prateleira da zona do congelador .....	426
4.8 Substituir o recipiente para alimentos congelados.....	427
4.8.1 Remover o recipiente para alimentos congelados.....	427
4.8.2 Instalar o recipiente para alimentos congelados .....	427
4.9 Substituir o recipiente para fruta e vegetais .....	428
4.9.1 Remover o recipiente para fruta e vegetais .....	428
4.9.2 Instalar o recipiente para fruta e vegetais.....	428
4.10 Substituir a secção e a tampa do recipiente para fruta e vegetais .....	429
4.10.1 Remover a secção e a tampa do recipiente para fruta e vegetais .....	429
4.10.2 Instalar a secção e a tampa do recipiente para fruta e vegetais.....	429
4.11 Substituir o recipiente de frio.....	430
4.11.1 Remover o recipiente de frio .....	430
4.11.2 Instalar o recipiente de frio .....	430
4.12 Substituir o recipiente extensível.....	431
4.12.1 Remover o recipiente extensível.....	431
4.12.2 Instalar o recipiente extensível .....	431
4.13 Substituir a iluminação LED específica.....	432
4.13.1 Remover a iluminação LED específica.....	432
4.13.2 Instalar a iluminação LED específica .....	433

# Sobre este documento

## 1.1 Informação importante

### 1.1.1 Finalidade

Estas dicas de reparação auxiliam o consumidor na reparação de aparelhos por ele próprio de acordo com o regulamento de "Eco-design" aplicável (a partir de 03/2021).

Estas contêm informações sobre como substituir peças sobressalentes definidas, incluindo avisos e riscos.

Em caso de dúvidas, entre em contacto com o nosso serviço de apoio ao cliente. Apenas nos responsabilizaremos por danos se as dicas de reparação tiverem sido devidamente seguidas.

## 1.2 Explicação dos símbolos

### 1.2.1 Níveis de perigo

Os níveis de aviso são compostos por um símbolo e uma palavra sinal. A palavra-sinal indica a gravidade do perigo.







Nível de aviso	Significado
 <b>PERIGO</b>	A não observância da mensagem de aviso resulta em morte ou ferimentos graves.
 <b>AVISO</b>	A não observância da mensagem de aviso pode resultar em morte ou ferimentos graves.
 <b>CUIDADO</b>	A não observância da mensagem de aviso pode resultar em ferimentos ligeiros.
<b>ATENÇÃO!</b>	A não observância da mensagem de aviso pode resultar em danos materiais.

Tabela 1: Níveis de perigo

### 1.2.2 Símbolos de perigo

Os símbolos de perigo são representações simbólicas que dão uma indicação do tipo de perigo.

Neste documento são utilizados os seguintes símbolos de perigo:

Símbolo de perigo	Significado
	Mensagem geral de aviso
	Perigo de tensão elétrica
	Risco de explosão
	Perigo de cortes

## **i** Sobre este documento





Símbolo de perigo	Significado
	Perigo de esmagamento
	Perigo de superfícies quentes
	Perigo de campo eletromagnético intenso
	Perigo de radiação não-ionizante

Tabela 2: Símbolos de perigo

### 1.2.3 Estrutura dos avisos

Os avisos neste documento possuem um aspeto normalizado e uma estrutura normalizada.

	<div style="background-color: red; color: white; padding: 2px; text-align: center;"><b>⚠ PERIGO</b></div> <p><b>Tipo e origem do perigo!</b> Possíveis consequência de ignorar o perigo / aviso.</p> <ul style="list-style-type: none"> <li>▶ Medidas e proibições para prevenir o perigo.</li> </ul>
--	---

O seguinte exemplo mostra um aviso que adverte contra choques elétricos devido a partes sob tensão. A medida para evitar o perigo é mencionada.

	<div style="background-color: red; color: white; padding: 2px; text-align: center;"><b>⚠ PERIGO</b></div> <p><b>Risco de choque elétrico devido a partes sob tensão!</b> Morte por eletrocussão</p> <ul style="list-style-type: none"> <li>▶ Desligue os aparelhos da alimentação elétrica pelo menos 60 segundos antes de iniciar as reparações.</li> </ul>
--	--

### 1.2.4 Símbolos gerais

Neste documento são utilizados os seguintes símbolos gerais:







Símbolo ger.	Significado
	Identificação de uma dica especial (texto e/ou ilustração)
	Identificação de uma dica simples (apenas texto)
	Identificação de uma ligação para um tutorial em vídeo
	Identificação das ferramentas necessárias
	Identificação das condições prévias necessárias
	Identificação de uma condição (se ..., então ...)
	Identificação de um resultado
Iniciar	Identificação de uma tecla ou botão
[00123456]	Identificação de um número de material
Estado	Identificação de um texto exibido / janela (no visor do aparelho)

Tabela 3: Símbolos gerais

## 2.1 Instruções gerais de segurança

### 2.1.1 Todos os eletrodomésticos

#### **Risco de choque elétrico devido a partes sob tensão!**

- Erros por reparações envolvendo componentes elétricos podem provocar choques elétricos!
- Desligue o aparelho da rede elétrica pelo menos 60 segundos antes de iniciar o trabalho.
- Após a reparação, solicite a realização de um teste de segurança de acordo com VDE 0701 ou os regulamentos específicos do país.

#### **Risco de ferimentos causados por arestas vivas!**

- Use luvas de proteção.

#### **Risco de esmagamento durante trabalhos de reparação, manutenção, resolução de problemas e serviço devido a componentes pesados e móveis**

- Use calçado de proteção.
- Proteja os componentes pesados contra quedas.
- Não introduzir partes do corpo em componentes móveis.



#### **Risco para a segurança/funcionamento do aparelho!**

- Utilize apenas peças sobressalentes originais.

#### **Risco de danos em componentes electrostaticamente sensíveis (ESDs)!**

- Não toque nos módulos, incluindo ligações e percursos condutores.

## Ferramentas e auxiliares

Designação	Detalhes	Imagens
Pano protetor [00342013]	60 cm x 50 cm	
Ponta Torx TX20 [00340865]	6,3 mm (1/4")	
Ferramenta especial [00342180]		

## 4.1 Substituir a junta da porta

### Pré-requisito:

- ✔ A porta está aberta.

### 4.1.1 Remover a junta da porta

1. Solte a junta da porta da ranhura nos cantos direito e esquerdo.

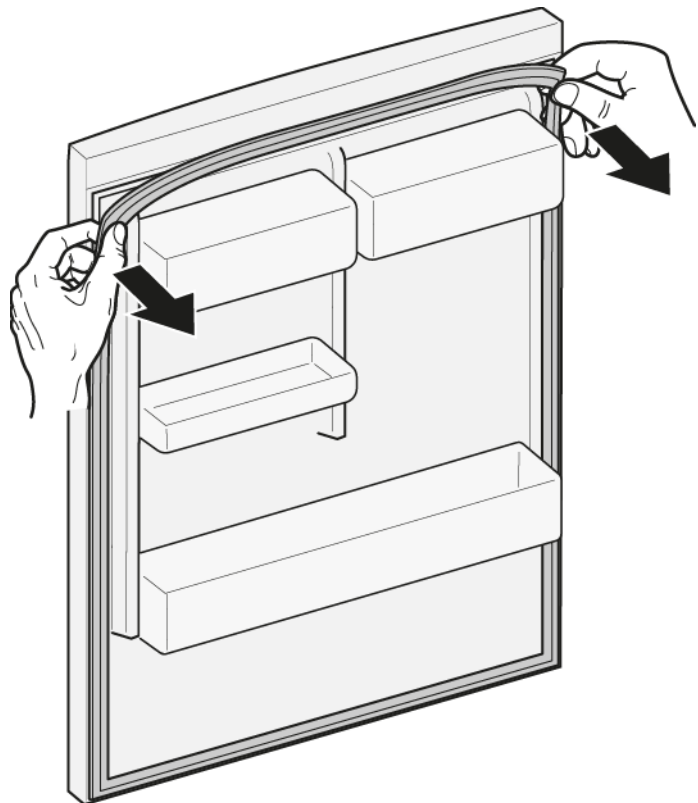

2. Puxe a junta da porta para fora da ranhura.

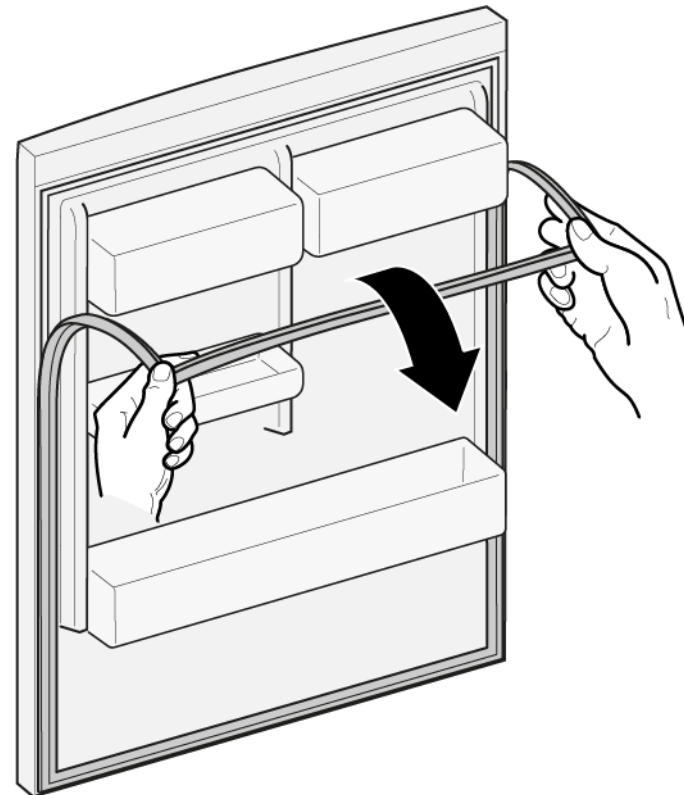

- ➡ A junta da porta está removida.

### 4.1.2 Instalar a junta da porta

	A espessura da nova junta da porta pode divergir ligeiramente da da junta antiga da porta. Isto não afetará o comportamento de fecho nem o funcionamento a longo termo.
	Se o seu aparelho dispor de dobradiças ou fixações de dobradiça ajustáveis, poderá otimizar o comportamento de fecho subsequentemente.
	Os pequenos orifícios laterais na junta da porta são funcionais (necessários à ventilação). Não se trata de falhas de produção.

## Reparação

1. Verifique se a ranhura para a junta apresenta danos.

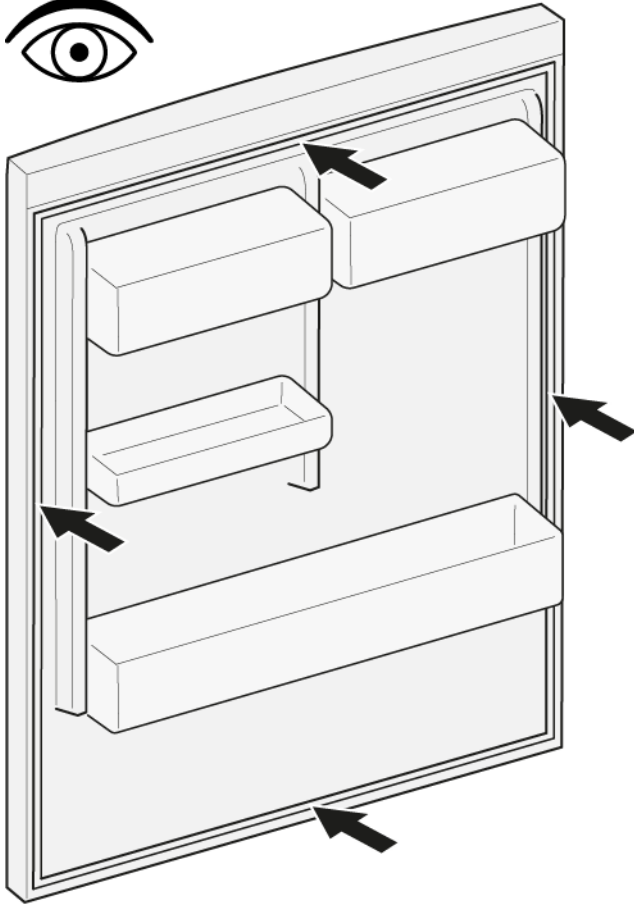

4. Empurre os cantos da junta em cima e em baixo para ranhura.

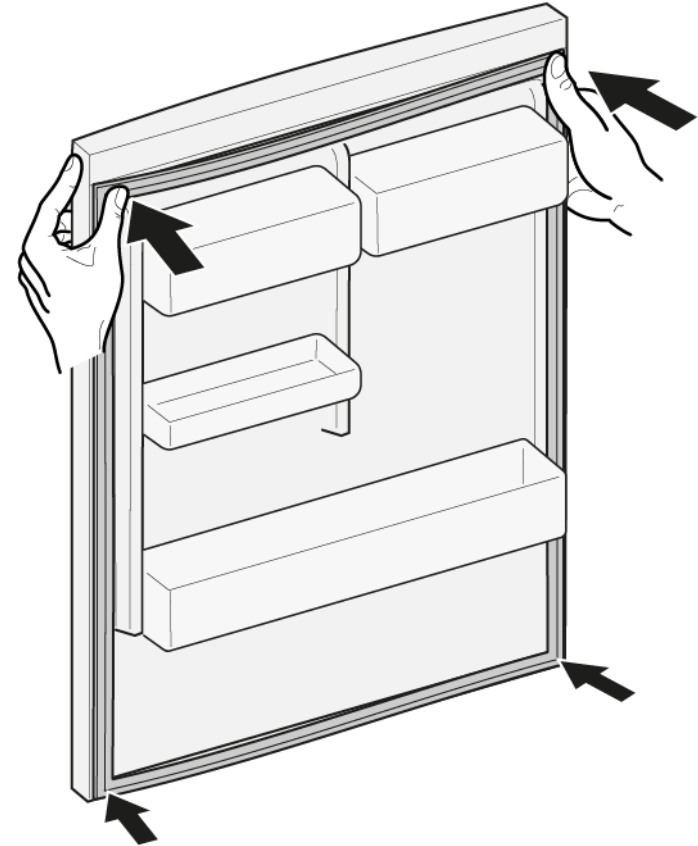

2.  Se a ranhura para a junta estiver danificada,  
- contacte o serviço de apoio ao consumidor.

3.  Uma deformação ligeira da junta da porta é normal e não afeta o seu funcionamento. Recomenda-se que a junta da porta seja endireitada antes de ser inserida no aparelho.

Aqueça a junta da porta com a um secador de cabelo ou água quente e mude a sua forma manualmente.



## Reparação

5. Pressione a junta inteira gradualmente para dentro da ranhura.

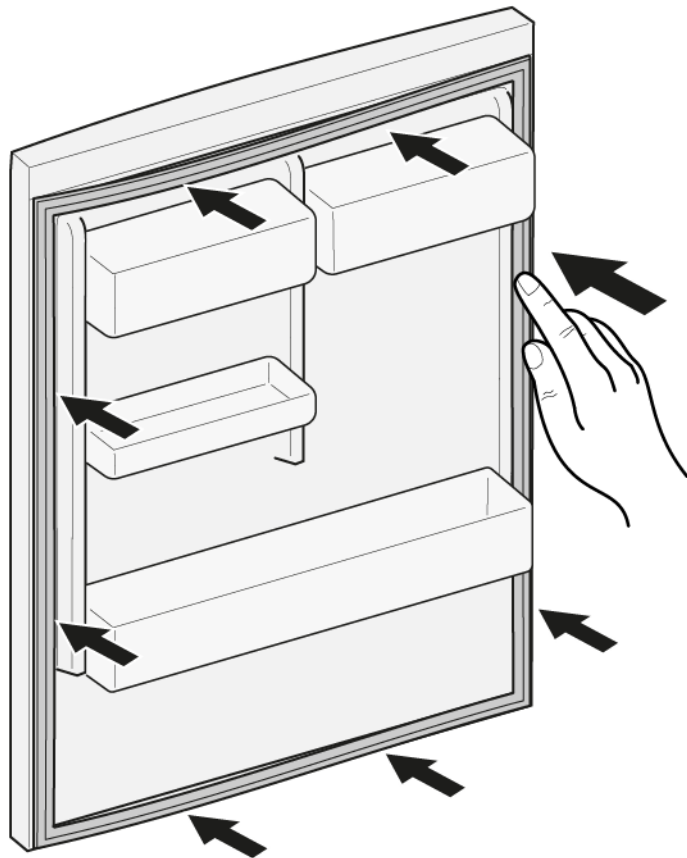



-  A junta da porta está instalada.

## 4.2 Substituir a dobradiça plana

### Ferramentas necessárias:

🔧 Ponta Torx TX20      6,3 mm (1/4")      [00340865]

	<b>⚠️ AVISO</b>
	<b>Aparelhos pesados e volumosos!</b> Lesões nas costas e musculares <ul style="list-style-type: none"><li>▶ A operação de remoção da porta do aparelho deve ser apenas executada por especialistas formados.</li><li>▶ São necessárias duas pessoas para mover o aparelho.</li><li>▶ Use apenas ferramentas e equipamento adequados.</li></ul>

	<b>⚠️ CUIDADO</b>
	<b>Arestas vivas!</b> Lesões por corte <ul style="list-style-type: none"><li>▶ Use luvas de proteção.</li></ul>

	<b>⚠️ CUIDADO</b>
	<b>Zona das dobradiças aberta!</b> Esmagamento / entalamento dos dedos <ul style="list-style-type: none"><li>▶ Não coloque as mãos na zona das dobradiças.</li><li>▶ Use luvas de proteção.</li></ul>

	<b>⚠️ CUIDADO</b>
	<b>Risco de queda de peças devido a parafusos desapertados!</b> Lesões devido à queda de peças. <ul style="list-style-type: none"><li>▶ Proteja o componente contra as quedas.</li></ul>

	<b>ATENÇÃO!</b>
	<b>Risco de queda de peças devido a parafusos desapertados!</b> Danos em outros componentes do aparelho ou na casa do cliente, p. ex., no pavimento. <ul style="list-style-type: none"><li>▶ Proteja o componente contra as quedas.</li></ul>

### Pré-requisito:

- ✔ O aparelho está desligado da alimentação elétrica.
- ✔ As portas do móvel estão removidas. Ver as instruções de instalação.
- ✔ A porta está aberta.

## 4.2.1 Remover a dobradiça plana

Assegure-se de que as dobradiças não fechem durante a remoção / instalação.



The diagram illustrates the process of removing a flat hinge. On the left, a door is shown with arrows indicating it should be held open. A thought bubble with a question mark suggests a common mistake. On the right, a hand is shown holding the hinge, with a warning icon (!) indicating the danger of the hinge closing. An information icon (i) is also present.

1. Remova quatro tampas de dobradiça.

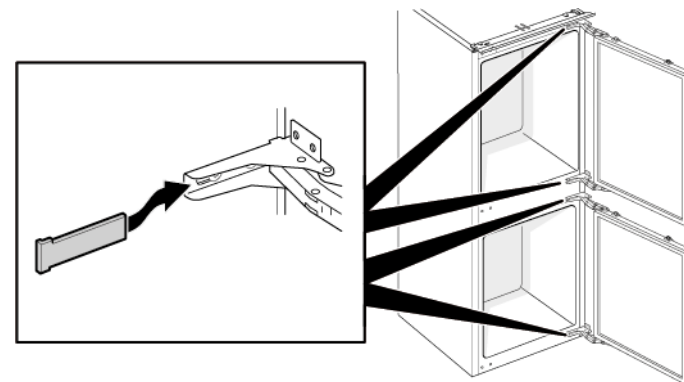

## Reparação

2. 1. Solte quatro parafusos (1).
2. Deslize para fora e remova a porta superior (2).

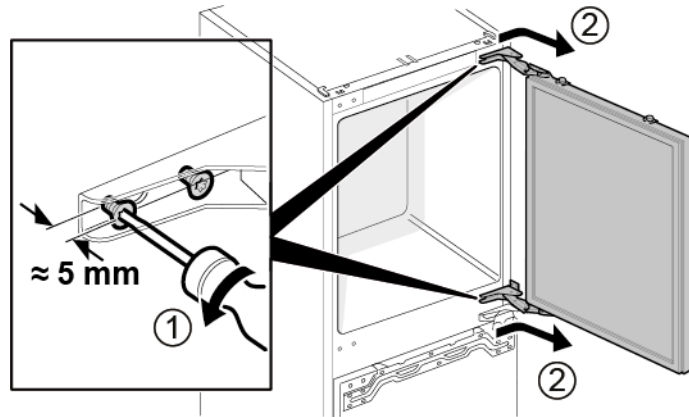

3. 1. Remova quatro parafusos (1).
2. Remova as dobradiças (2).

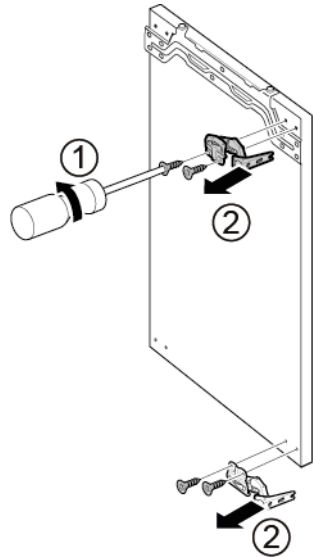

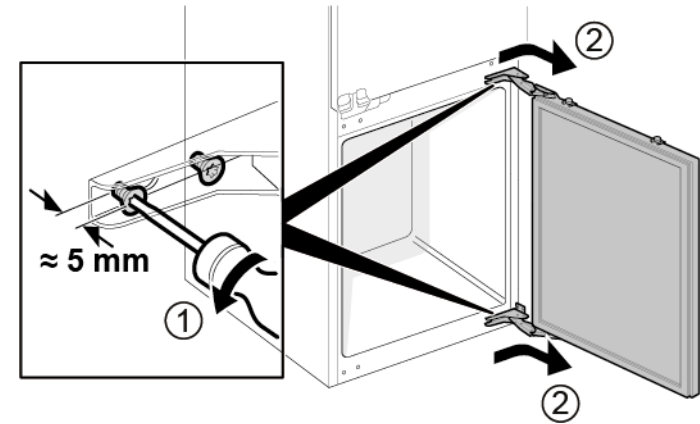

 As dobradiças superiores da porta estão removidas.

4. 1. Solte quatro parafusos (1).
2. Deslize para fora e remova a porta inferior (2).

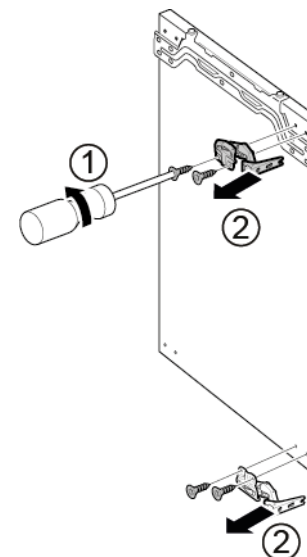

5. 1. Remova quatro parafusos (1).
2. Remova as dobradiças (2).



 As dobradiças inferiores da porta estão removidas.

### **4.2.2 Instalar a dobradiça plana**

- ▶ Instale pela ordem inversa.

## 4.3 Substituir a dobradiça deslizante

### Ferramentas necessárias:

🌀 Ponta Torx TX20      6,3 mm (1/4")      [00340865]

	<b>⚠️ AVISO</b>
	<b>Aparelhos pesados e volumosos!</b> Lesões nas costas e musculares <ul style="list-style-type: none"><li>▶ A operação de remoção da porta do aparelho deve ser apenas executada por especialistas formados.</li><li>▶ São necessárias duas pessoas para mover o aparelho.</li><li>▶ Use apenas ferramentas e equipamento adequados.</li></ul>

	<b>⚠️ CUIDADO</b>
	<b>Arestas vivas!</b> Lesões por corte <ul style="list-style-type: none"><li>▶ Use luvas de proteção.</li></ul>

	<b>⚠️ CUIDADO</b>
	<b>Risco de queda de peças devido a parafusos desapertados!</b> Lesões devido à queda de peças. <ul style="list-style-type: none"><li>▶ Proteja o componente contra as quedas.</li></ul>

	<b>ATENÇÃO!</b>
	<b>Risco de queda de peças devido a parafusos desapertados!</b> Danos em outros componentes do aparelho ou na casa do cliente, p. ex., no pavimento. <ul style="list-style-type: none"><li>▶ Proteja o componente contra as quedas.</li></ul>

### Pré-requisito:

- ✔ O aparelho está desligado da alimentação elétrica.
- ✔ A porta do móvel e a porta do aparelho estão separadas. Ver as instruções de instalação.

## 4.3.1 Remover a dobradiça deslizante

1. Desaperte dois parafusos (1).
2. Remova a dobradiça superior da porta superior (2).
3. Remova a porta superior (3).
4. Desaperte dois parafusos (4).
5. Remova a dobradiça superior da porta inferior (5).
6. Remova a porta inferior (6).

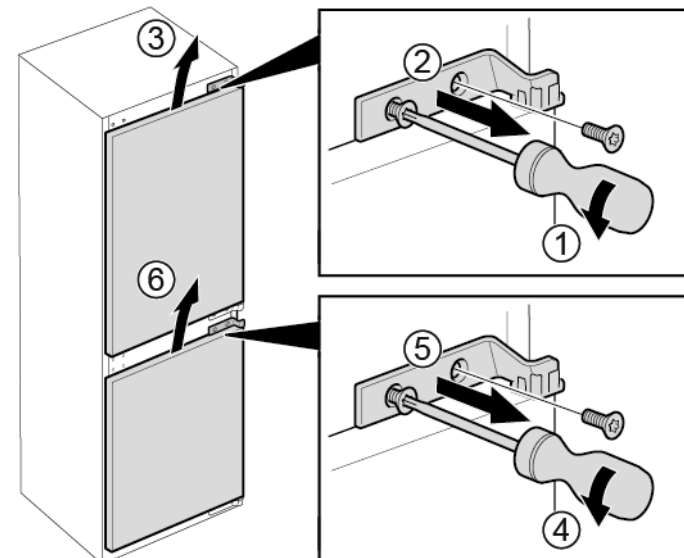

## Reparação

2. 1. Remova quatro parafusos (1).
2. Remova as dobradiças inferiores (2).

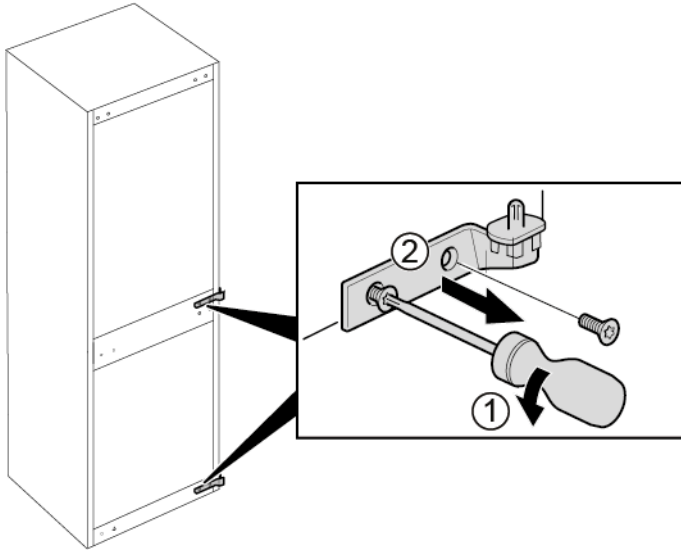

 As dobradiças estão removidas.

### 4.3.2 Instalar a dobradiça deslizante

- ▶ Instale pela ordem inversa.

## 4.4 Substituir a prateleira da porta

Pré-requisito:

- ✔ A porta está aberta.

### 4.4.1 Remover a prateleira da porta

- ▶ Levante a prateleira da porta.

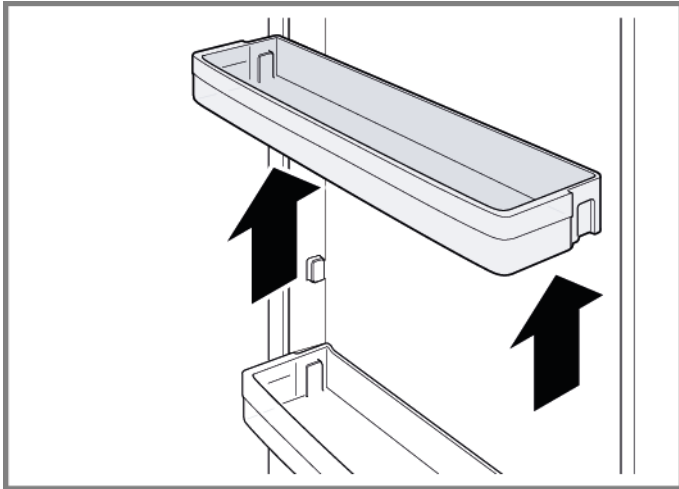

➡ A prateleira da porta está removida.

### 4.4.2 Instalar a prateleira da porta

- ▶ Instale pela ordem inversa.

## 4.5 Substituir a prateleira

Pré-requisito:

- ✔ A porta está aberta.

### 4.5.1 Remover a prateleira

- ▶ Puxe a prateleira para fora.

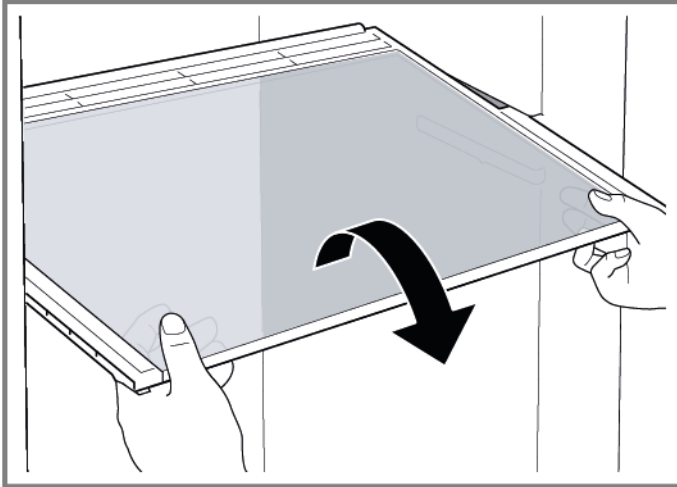

➡ A prateleira está removida.

### 4.5.2 Instalar a prateleira

- ▶ Instale pela ordem inversa.



## 4.6 Substituir a prateleira extensível

Pré-requisito:

- ✔ A porta está aberta.

### 4.6.1 Remover a prateleira extensível

1. Puxe para fora a prateleira extensível até o bloqueio de retenção se soltar.

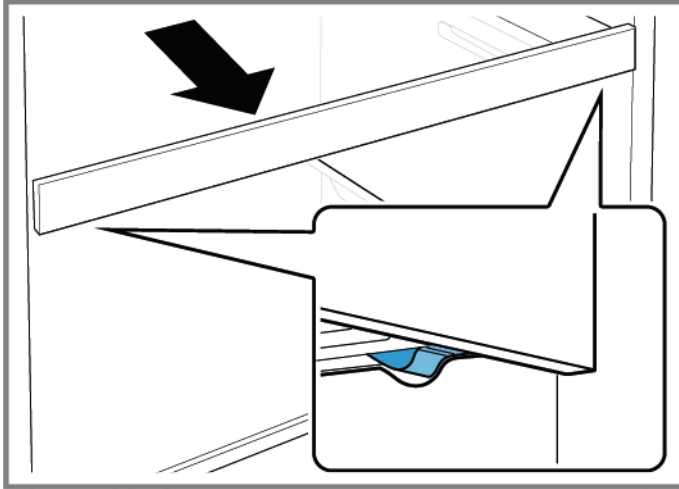

2. Desça a prateleira extensível e vire-a para fora lateralmente.
3. ➡ A prateleira extensível está removida.

### 4.6.2 Instalar a prateleira extensível

- ▶ Instale pela ordem inversa.

## 4.7 Substituir a prateleira da zona do congelador

Pré-requisito:

- ✔ A porta está aberta.

### 4.7.1 Remover a prateleira da zona do congelador

- ▶ Puxe para fora a prateleira da zona do congelador.

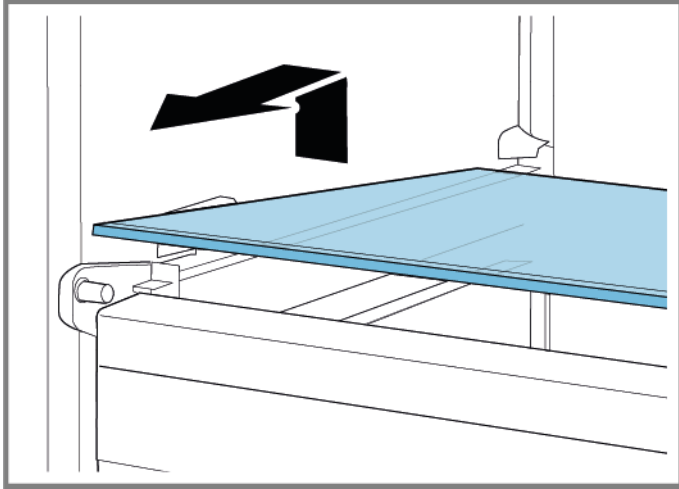

- ➡ A prateleira da zona do congelador está removida.

### 4.7.2 Instalar a prateleira da zona do congelador

- ▶ Instale pela ordem inversa.

### 4.8 Substituir o recipiente para alimentos congelados

#### Pré-requisito:

- ✔ A porta está aberta.

#### 4.8.1 Remover o recipiente para alimentos congelados

- ▶ 1. Puxe o recipiente para alimentos congelados inteiramente para fora (1).
- ▶ 2. Remova o recipiente para alimentos congelados (2).

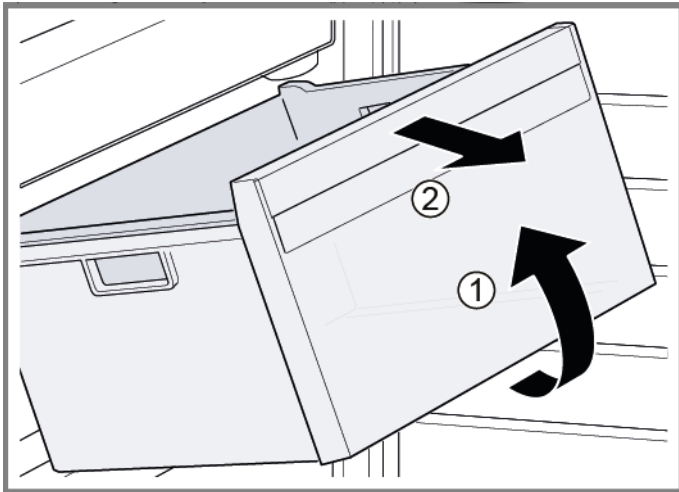

- ➡ O recipiente para alimentos congelados está removido.

#### 4.8.2 Instalar o recipiente para alimentos congelados

- ▶ Instale pela ordem inversa.

## 4.9 Substituir o recipiente para fruta e vegetais

### Pré-requisito:

- ✔ A porta está aberta.

### 4.9.1 Remover o recipiente para fruta e vegetais

- ▶ 1. Puxe o recipiente inteiramente para fora (1).
- ▶ 2. Remova o recipiente (2).

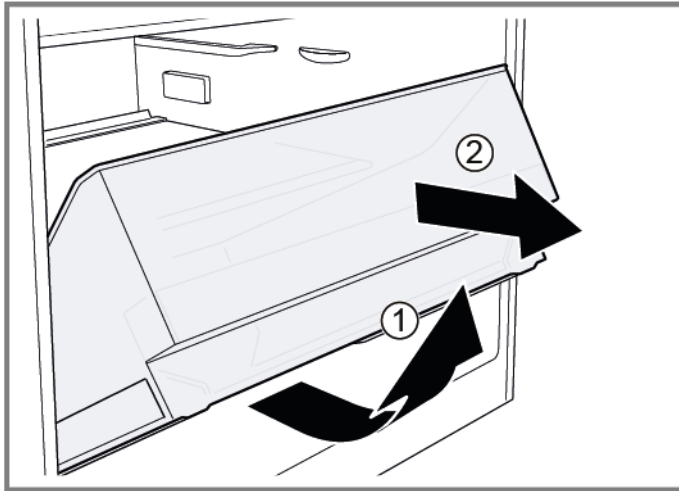

- ➡ O recipiente está removido.

### 4.9.2 Instalar o recipiente para fruta e vegetais

- ▶ Instale pela ordem inversa.

### 4.10 Substituir a secção e a tampa do recipiente para fruta e vegetais

#### Pré-requisito:

- ✔ A porta está aberta.

#### 4.10.1 Remover a secção e a tampa do recipiente para fruta e vegetais

1. Remova a placa de vidro da secção.

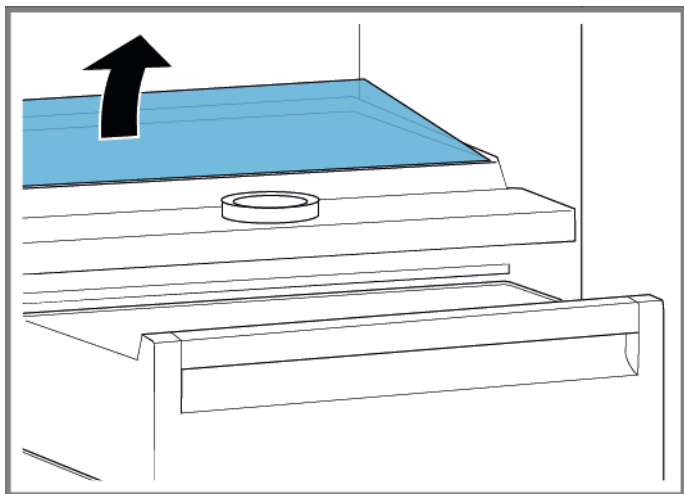

2. [Remova o recipiente para fruta e vegetais. →428](#)

3. 1. Pressione a alavanca do lado inferior de ambos os lados da secção (1).
2. Puxe a secção para a frente (2).

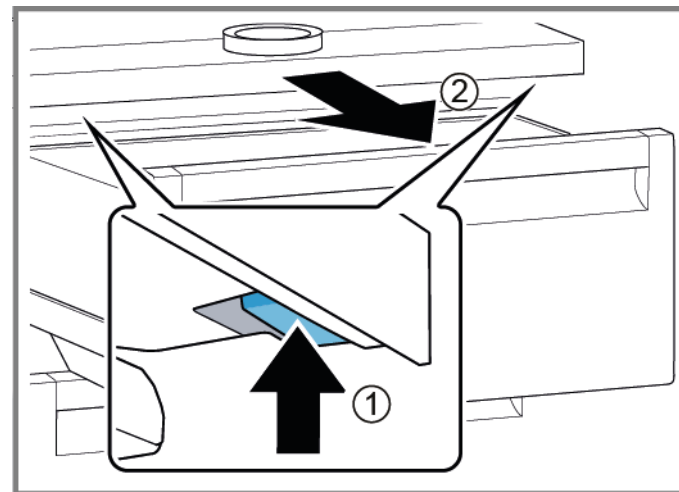

4. Levante a secção e gire-a para fora lateralmente.  
➡ A secção está removida.
5. 1. Levante a tampa do recipiente para fruta e vegetais.  
2. Puxe a tampa do recipiente para fruta e vegetais para a frente e gire-a para fora lateralmente.  
➡ A tampa do recipiente para fruta e vegetais está removida.

#### 4.10.2 Instalar a secção e a tampa do recipiente para fruta e vegetais

- ▶ Instale pela ordem inversa.

## 4.11 Substituir o recipiente de frio

### Pré-requisito:

- ✔ A porta está aberta.

### 4.11.1 Remover o recipiente de frio

- ▶ 1. Incline o recipiente de frio para a frente (1).
- ▶ 2. Remova o recipiente de frio (2).

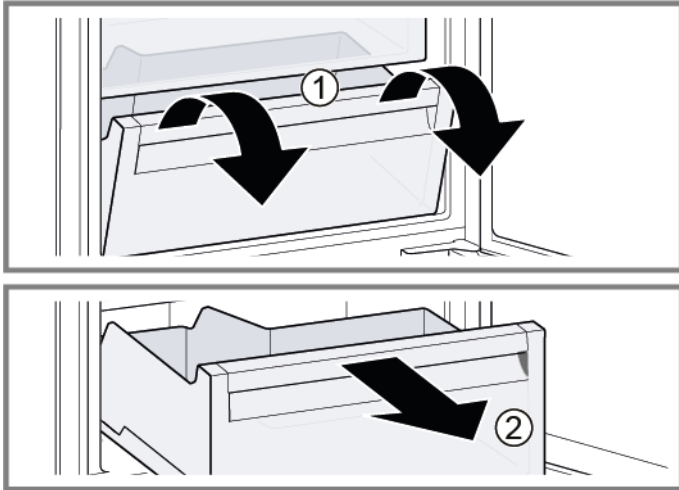

➡ O recipiente de frio está removido.

### 4.11.2 Instalar o recipiente de frio

- ▶ Instale pela ordem inversa.

## 4.12 Substituir o recipiente extensível

Pré-requisito:

- ✔ A porta está aberta.

### 4.12.1 Remover o recipiente extensível

- ▶ 1. Incline o recipiente extensível para a frente (1).
- ▶ 2. Remova o recipiente extensível (2).

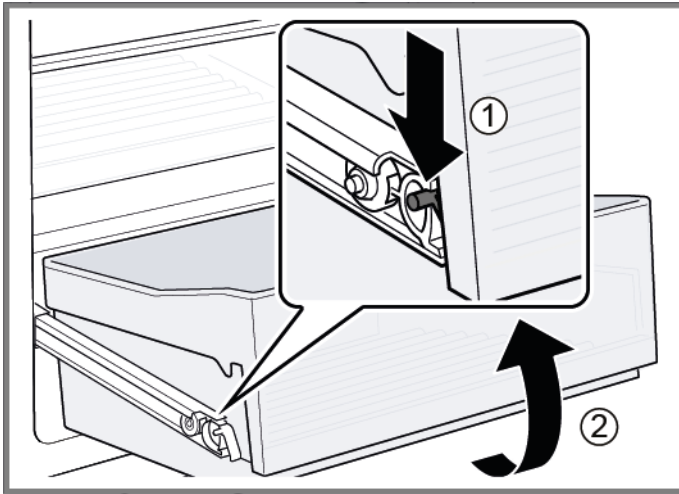



➡ O recipiente extensível está removido.

### 4.12.2 Instalar o recipiente extensível

- ▶ Instale pela ordem inversa.

## 4.13 Substituir a iluminação LED específica

### Ferramentas necessárias:

-  Ferramenta especial [00342180]
-  Chave de fendas Lâmina 2,4 mm x 0,4 mm x 60 mm, no kit [00341820]



O seu aparelho dispõe de uma iluminação LED isenta de manutenção. Estas iluminações só podem ser reparadas pelo serviço de apoio ao consumidor ou por técnicos autorizados!



### PERIGO

#### Risco de choque elétrico devido a partes sob tensão!

Risco de vida devido a choque elétrico em caso de reparação inadequada

- ▶ As partes elétricas devem ser reparadas por um electricista qualificado.
- ▶ Após a reparação, solicite a realização de um teste de segurança de acordo com VDE 0701 ou os regulamentos específicos do país.



### PERIGO

#### Risco de choque elétrico devido a partes sob tensão!

Morte por eletrocussão

- ▶ Desligue os aparelhos da alimentação elétrica pelo menos 60 segundos antes de iniciar as reparações.





### CUIDADO

#### Arestas vivas!

Lesões por corte

- ▶ Use luvas de proteção.

### Pré-requisito:

-  O aparelho está desligado da alimentação elétrica.
-  A porta está aberta.
-  As prateleiras do compartimento de refrigeração estão removidas.

## 4.13.1 Remover a iluminação LED específica

1. Solte a tampa da iluminação LED específica.

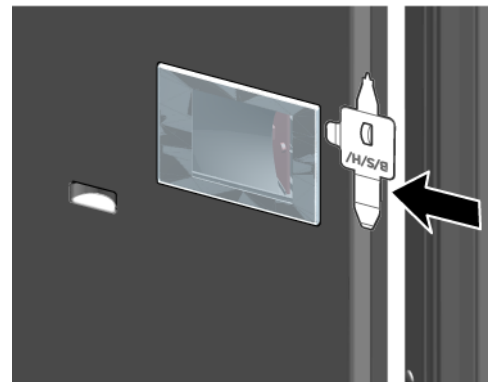

2. Puxe a tampa da iluminação LED específica para dentro, empurrando para a frente em simultâneo.

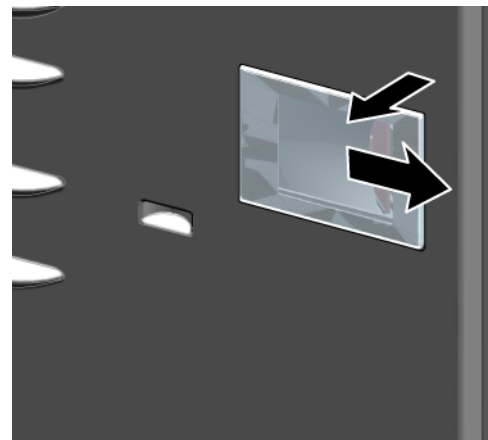



## Reparação

3. Desprenda o módulo da iluminação LED específica.

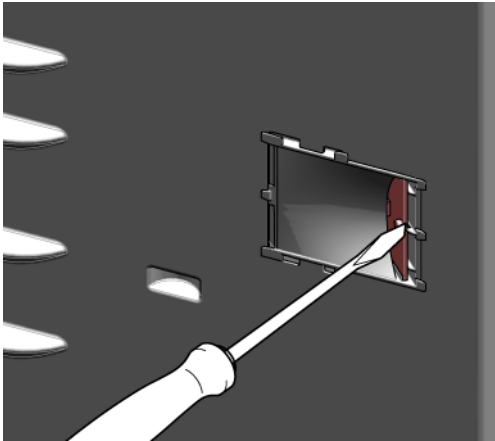

4. Desconecte a ligação elétrica da iluminação LED específica.

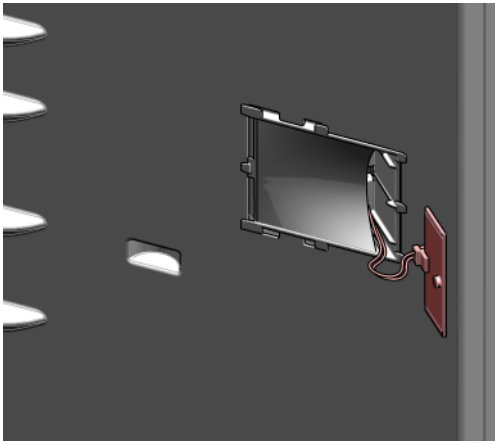





-  A iluminação LED específica está removida.

### 4.13.2 Instalar a iluminação LED específica

- ▶ Instale pela ordem inversa.

# Indicii pentru reparații - Combinație aparat de răcire/congelare

 <b>Referitor la acest document</b> .....	<b>435</b>	4.8 Repoziționarea containerului pentru alimente înghețate.....	451
1.1 Informații importante .....	435	4.8.1 Demontarea containerului pentru alimente înghețate .....	451
1.1.1 Aplicabilitatea .....	435	4.8.2 Montarea containerului pentru alimente înghețate .....	451
1.2 Explicația simbolurilor .....	435	4.9 Repoziționarea containerului pentru fructe și legume.....	452
1.2.1 Nivelurile de pericol.....	435	4.9.1 Demontarea containerului pentru fructe și legume .....	452
1.2.2 Simbolurile de pericol .....	435	4.9.2 Montarea containerului pentru fructe și legume .....	452
1.2.3 Structura avertismentelor.....	436	4.10 Repoziționarea separatorului și a capacului containerului pentru fructe și le- gume.....	453
1.2.4 Simbolurile generale .....	436	4.10.1 Demontarea separatorului și a capacului containerului pentru fructe și legume .....	453
 <b>Siguranța</b> .....	<b>437</b>	4.10.2 Montarea separatorului și a capacului containerului pentru fructe și legume.....	453
2.1 Instrucțiuni generale de siguranță .....	437	4.11 Repoziționarea containerului pentru alimente proaspete.....	454
2.1.1 Toate aparatele electrocasnice .....	437	4.11.1 Demontarea containerului pentru alimente proaspete .....	454
 <b>Instrumente și materiale utile</b> .....	<b>438</b>	4.11.2 Montarea containerului pentru alimente proaspete.....	454
 <b>Repararea</b> .....	<b>439</b>	4.12 Repoziționarea containerului extensibil.....	455
4.1 Înlocuirea garniturii ușii .....	439	4.12.1 Demontarea containerului extensibil .....	455
4.1.1 Demontarea garniturii ușii.....	439	4.12.2 Montarea containerului extensibil.....	455
4.1.2 Montarea garniturii ușii .....	439	4.13 Înlocuirea spotului luminos LED .....	456
4.2 Înlocuirea balamalei plate.....	442	4.13.1 Demontarea spotului luminos LED.....	456
4.2.1 Demontarea balamalei plate .....	442	4.13.2 Montarea spotului luminos LED .....	457
4.2.2 Montarea balamalei plate .....	444		
4.3 Înlocuirea balamalei glisante .....	445		
4.3.1 Demontarea balamalei glisante .....	445		
4.3.2 Montarea balamalei glisante .....	446		
4.4 Repoziționarea raftului pentru ușă .....	447		
4.4.1 Demontarea raftului pentru ușă .....	447		
4.4.2 Montarea raftului pentru ușă .....	447		
4.5 Repoziționarea raftului .....	448		
4.5.1 Demontarea raftului.....	448		
4.5.2 Montarea raftului .....	448		
4.6 Repoziționarea raftului extensibil .....	449		
4.6.1 Demontarea raftului extensibil.....	449		
4.6.2 Montarea raftului extensibil .....	449		
4.7 Repoziționarea raftului din compartimentul congelatorului .....	450		
4.7.1 Demontarea raftului din compartimentul congelatorului.....	450		
4.7.2 Montarea raftului din compartimentul congelatorului .....	450		

# **i** Referitor la acest document

## 1.1 Informații importante

### 1.1.1 Aplicabilitatea

Aceste instrucțiuni de reparare îl ajută pe client să își repare singur aparatele, în conformitate cu normele de proiectare ecologică aplicabile (începând cu 03/2021).





Acestea conțin informații privind modul de înlocuire a pieselor de schimb specifice, inclusiv avertismente și pericole.

Dacă aveți întrebări, vă rugăm să luați legătura cu serviciul relații clienți. Ne asumăm răspunderea pentru daune numai dacă instrucțiunile de reparare au fost respectate pe deplin.

## 1.2 Explicația simbolurilor

### 1.2.1 Nivelurile de pericol

Nivelurile de alertă sunt reprezentate printr-un simbol și un cuvânt de avertizare. Cuvântul de avertizare indică gravitatea pericolului.





Nivelul de alertă	Semnificație
 <b>PERICOL</b>	Nerespectarea mesajului de avertizare va provoca accidente grave sau decesul.
 <b>AVERTISMENT</b>	Nerespectarea mesajului de avertizare ar putea provoca accidente grave sau decesul.
 <b>ATENȚIONARE</b>	Nerespectarea mesajului de avertizare ar putea provoca accidente ușoare.
 <b>ATENȚIE!</b>	Nerespectarea mesajului de avertizare ar putea provoca daune asupra proprietății.

Tabel 1: Nivelurile de pericol



### 1.2.2 Simbolurile de pericol

Simbolurile de pericol sunt reprezentări simbolice care indică tipul de pericol.

În acest document sunt utilizate simbolurile de pericol de mai jos:

Simbol de pericol	Semnificație
	Mesaj de avertizare general
	Pericol din cauza tensiunii electrice
	Pericol de explozie
	Pericol de tăiere
	Pericol de zdrobire



## Referitor la acest document

Simbol de pericol	Semnificație
	Pericol din cauza suprafețelor fierbinți
	Pericol din cauza câmpului magnetic puternic
	Pericol din cauza radiației neionizante

Tabel 2: Simbolurile de pericol

### 1.2.3 Structura avertismentelor

Avertismentele din acest document au un aspect și o structură standard.



	<div style="background-color: red; color: white; padding: 2px; text-align: center;"> <b>PERICOL</b></div> <p><b>Tipul și sursa pericolului!</b> Consecințele posibile ale ignorării pericolului/avertismentului.</p> <ul style="list-style-type: none"> <li>▶ Măsuri și interdicții pentru prevenirea pericolului.</li> </ul>
--	--





Exemplul următor prezintă un avertisment privind electrocutarea din cauza pieselor sub tensiune. Se menționează măsura necesară pentru a evita pericolul.

	<div style="background-color: red; color: white; padding: 2px; text-align: center;"> <b>PERICOL</b></div> <p><b>Pericol de electrocutare din cauza pieselor sub tensiune!</b> Deces prin electrocutare</p> <ul style="list-style-type: none"> <li>▶ Deconectați aparatele de la sursa de alimentare cu tensiune cu cel puțin 60 de secunde înainte de a începe reparațiile.</li> </ul>
---	---

### 1.2.4 Simbolurile generale

În acest document sunt utilizate simbolurile generale de mai jos:

Simbol general	Semnificație
	Identificarea unei recomandări speciale (text și/sau grafică)
	Identificarea unei recomandări simple (numai text)

Simbol general	Semnificație
	Identificarea unui link spre un videoclip instructiv
	Identificarea sculelor necesare
	Identificarea condițiilor preliminare necesare
	Identificarea unei stări (dacă..., apoi...)
	Identificarea unui rezultat
[Pornire]	Identificarea unei taste sau a unui buton
[00123456]	Identificarea unui număr de serie
Stare	Identificarea unui text/unei ferestre afișate (pe ecranul aparatului)

Tabel 3: Simbolurile generale

## 2.1 Instrucțiuni generale de siguranță

### 2.1.1 Toate aparatele electrocasnice

#### **Pericol de electrocutare din cauza pieselor sub tensiune!**

- Erorile care au loc în timpul reparațiilor efectuate la componentele electrice pot să ducă la electrocutări!
- Deconectați aparatul de la sursa de alimentare cu tensiune cu cel puțin 60 de secunde înainte de a începe lucrările.
- După reparație, este obligatorie efectuarea unei verificări de siguranță conform cu VDE 0701 sau cu reglementările naționale respective.

#### **Pericol de rănire din cauza muchiilor ascuțite!**

- Purtați mănuși de protecție.

#### **Pericol de zdrobire în timpul lucrărilor de reparație, întreținere, depanare și service, din cauza componentelor grele și mobile**

- Purtați încălțăminte de protecție.
- Fixați componentele grele împotriva căderii.
- Nu vă sprijiniți cu părți ale corpului de componentele mobile.



#### **Pericol pentru siguranța/funcționarea aparatului!**

- Utilizați numai piese de schimb originale.

#### **Pericol de deteriorare a componentelor sensibile la electricitatea statică (ESD)!**

- Nu atingeți modulele, inclusiv conexiunile și căile conductorilor.

## Instrumente și materiale utile

Desemnare	Detalii	Imagini
Material textil de protecție [00342013]	60 cm x 50 cm	
Cap torx TX20 [00340865]	6,3 mm (1/4")	
Instrument special [00342180]		

## 4.1 Înlocuirea garniturii ușii

### Cerință:

- ✓ Ușa este deschisă.

### 4.1.1 Demontarea garniturii ușii

1. Îndepărtați garnitura ușii din canelura colțurilor din dreapta și stânga.

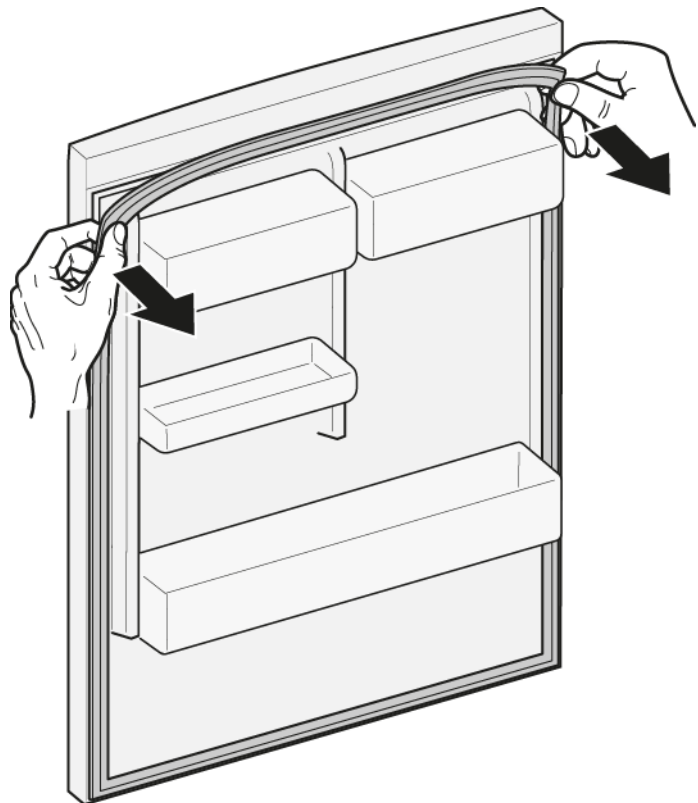

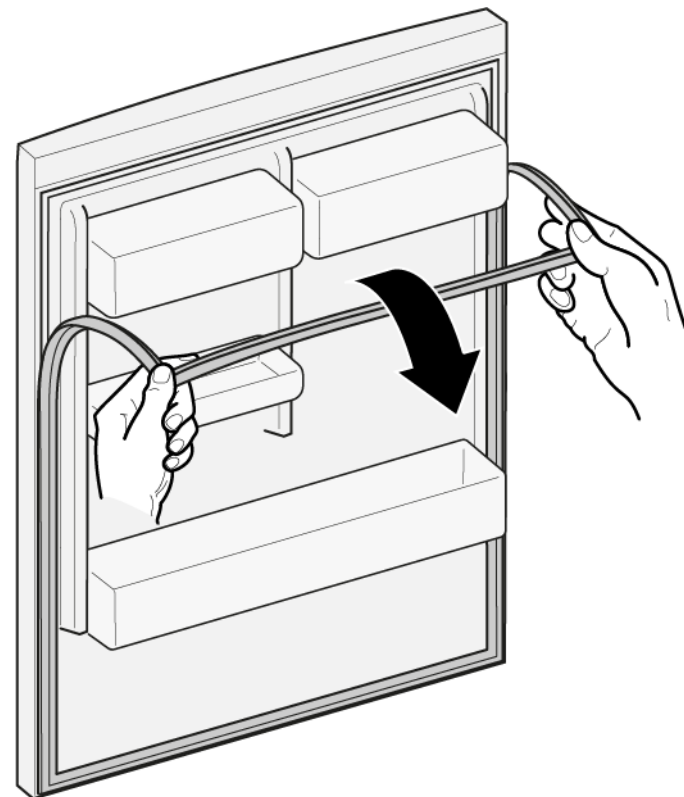

2. Demontați garnitura ușii din canelură.



- ➡ Garnitura ușii este demontată.

### 4.1.2 Montarea garniturii ușii

	Grosimea garniturii noi a ușii poate fi ușor diferită față de grosimea garniturii vechi a ușii. Acest lucru nu va afecta comportamentul de închidere și funcționarea pe termen lung.
	Dacă aparatul dumneavoastră are balamale reglabile sau accesorii pentru balamale, puteți optimiza comportamentul de închidere în consecință.
	Orificiile de mici dimensiuni practicate în garnitura ușii au rol funcțional (sunt necesare pentru ventilație). Ele nu sunt defecte ale produsului.

## Repararea

1. Verificați canelura pentru montarea garniturii și asigurați-vă că nu prezintă defecte.

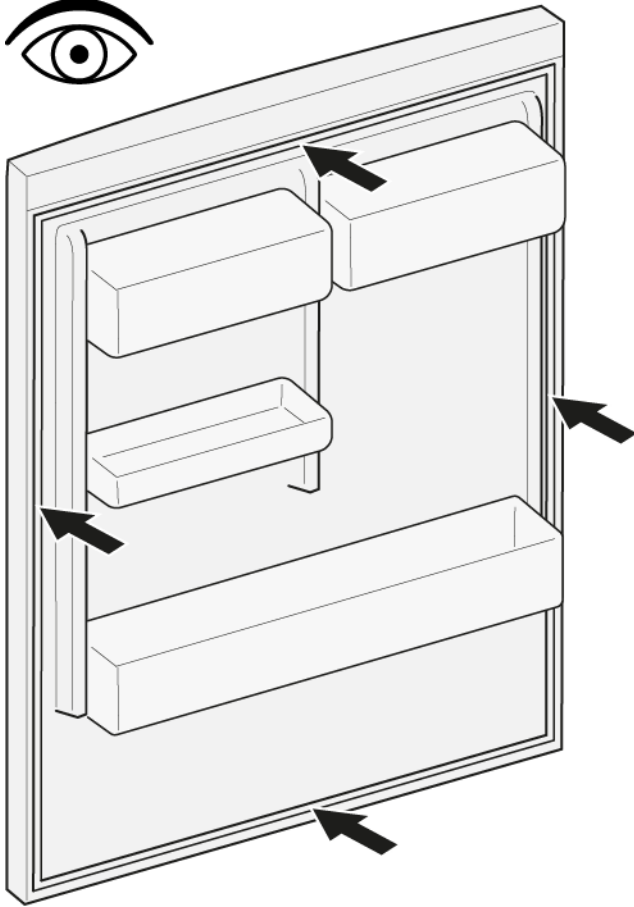

4. Împingeți colțurile de sus și de jos ale garniturii în canelură.

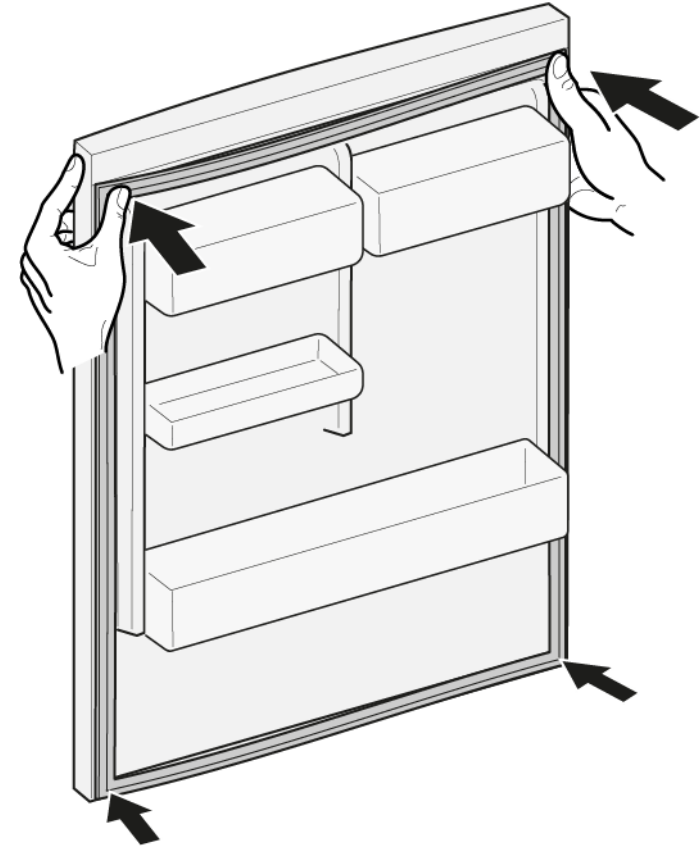

2.  Dacă canelura pentru montarea garniturii prezintă defecte, este deteriorată.  
- Contactați departamentul de service pentru clienți.

3.  O deformare ușoară a garniturii ușii este normală și nu afectează funcționarea acesteia. Se recomandă să îndreptați garnitura ușii înainte de a o introduce în aparat.

Încălziți garnitura ușii cu un uscător de păr sau cu apă fierbinte și remodelați-o cu mâna.



## Repararea

5. Apăsați întreaga garnitură în canelură, pas cu pas.

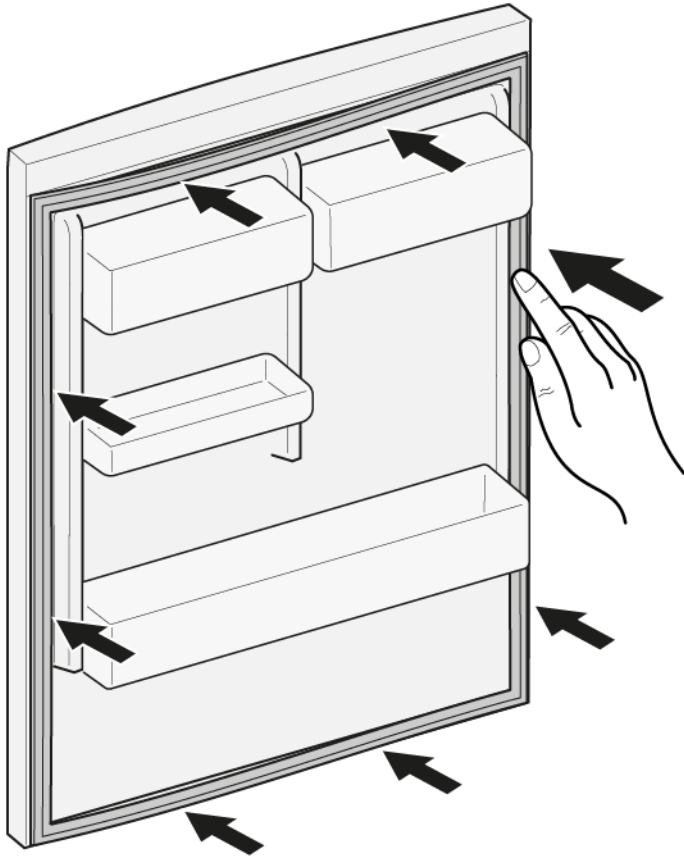

 Garnitura ușii este montată.





## 4.2 Înlocuirea balamalei plate

### Scule speciale:

Cap torx TX20

6,3 mm (1/4")

[00340865]

	<p><b>AVERTISMENT</b></p> <p><b>Aparate grele, masive!</b> Accidentarea spatelui și leziuni musculare</p> <ul style="list-style-type: none"> <li>▶ Operația de demontare a ușii aparatului trebuie efectuată numai de specialiști instruiți.</li> <li>▶ Pentru deplasarea aparatului sunt necesare două persoane.</li> <li>▶ Utilizați numai instrumente și echipamente adecvate.</li> </ul>
	<p><b>ATENȚIONARE</b></p> <p><b>Marginea ascuțită!</b> Rănire prin tăiere</p> <ul style="list-style-type: none"> <li>▶ Purtați mănuși de protecție.</li> </ul>
	<p><b>ATENȚIONARE</b></p> <p><b>Zona balamalei deschise!</b> Zdrobirea/prinderea degetelor</p> <ul style="list-style-type: none"> <li>▶ Nu introduceți degetele sau mâna în zona balamalei.</li> <li>▶ Purtați mănuși de protecție.</li> </ul>
	<p><b>ATENȚIONARE</b></p> <p><b>Pericol din cauza pieselor care cad pentru că șuruburile sunt slăbite!</b> Accidente din cauza pieselor care cad.</p> <ul style="list-style-type: none"> <li>▶ Fixați componenta împotriva căderii.</li> </ul>
	<p><b>ATENȚIE!</b></p> <p><b>Pericol din cauza pieselor care cad pentru că șuruburile sunt slăbite!</b> Deteriorarea altor piese ale aparatului sau a casei clientului, de exemplu, partea de jos.</p> <ul style="list-style-type: none"> <li>▶ Fixați componenta împotriva căderii.</li> </ul>

### Cerință:

- ✓ Aparatul este deconectat de la sursa de energie electrică.

- ✓ Ușa piesei de mobilier este demontată. Consultați Instrucțiunile de montare.
- ✓ Ușa este deschisă.

### 4.2.1 Demontarea balamalei plate

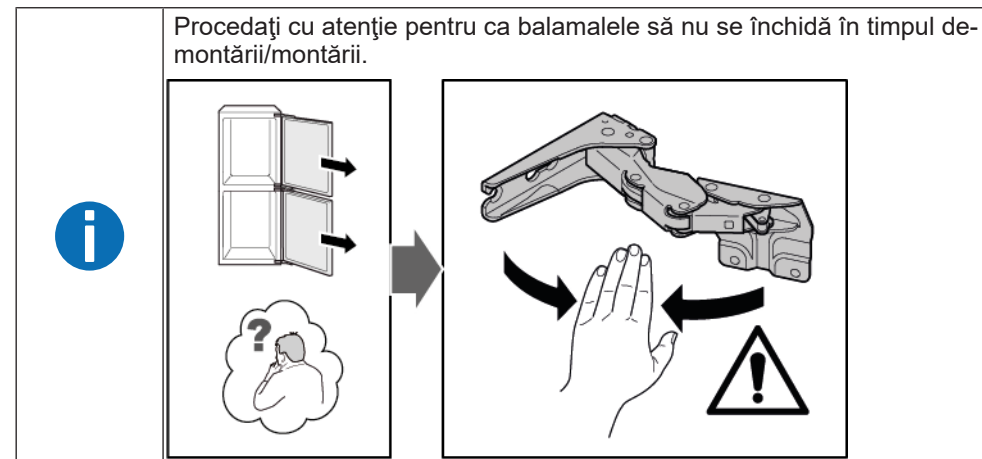

1. Demontați capacele a patru balamale.

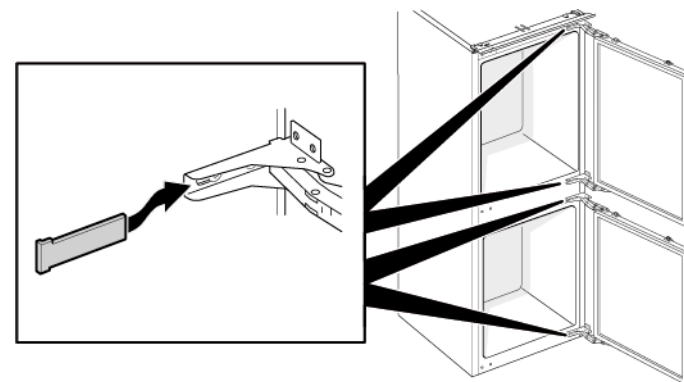

## Repararea

2. 1. Slăbiți patru șuruburi (1).  
2. Glisați ușa de sus în exterior și scoateți-o (2).

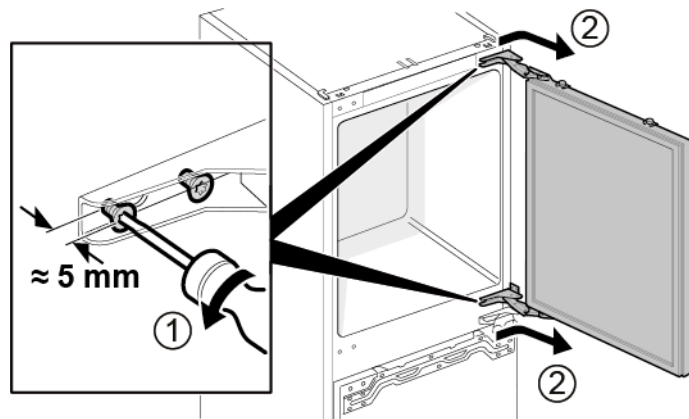

3. 1. Demontați patru șuruburi (1).  
2. Demontați balamalele (2).

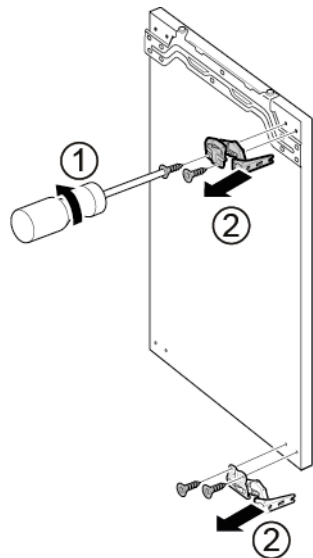

 Balamalele ușii de sus sunt demontate.

4. 1. Slăbiți patru șuruburi (1).  
2. Glisați ușa de jos în exterior și scoateți-o (2).

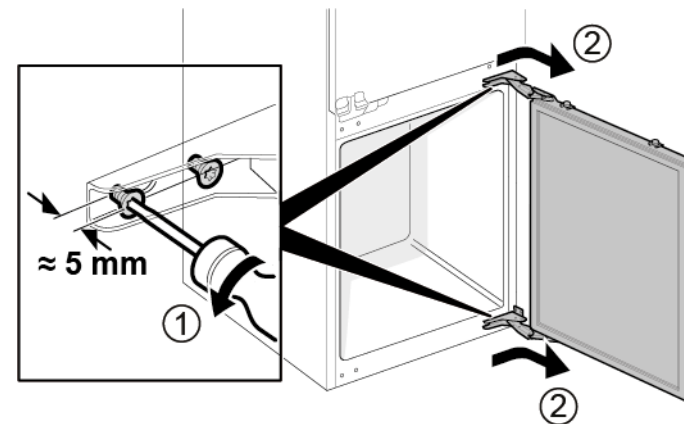

5. 1. Demontați patru șuruburi (1).  
2. Demontați balamalele (2).

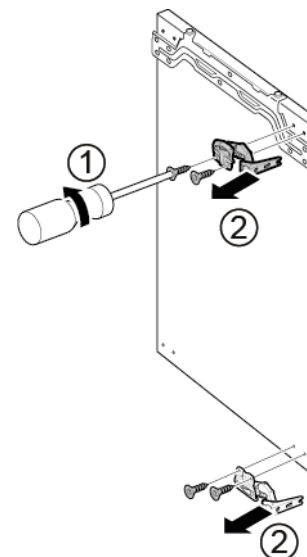

 Balamalele ușii de jos sunt demontate.

### **4.2.2 Montarea balamalei plate**

- ▶ Montați urmând procedura de demontare în ordine inversă.

## 4.3 Înlocuirea balamalei glisante

### Scule speciale:

🌀 Cap torx TX20                      6,3 mm (1/4")                      [00340865]

	<b>⚠️ AVERTISMENT</b>
	<b>Aparate grele, masive!</b> Accidentarea spatelui și leziuni musculare <ul style="list-style-type: none"><li>▶ Operația de demontare a ușii aparatului trebuie efectuată numai de specialiști instruiți.</li><li>▶ Pentru deplasarea aparatului sunt necesare două persoane.</li><li>▶ Utilizați numai instrumente și echipamente adecvate.</li></ul>

	<b>⚠️ ATENȚIONARE</b>
	<b>Marginea ascuțită!</b> Rănire prin tăiere <ul style="list-style-type: none"><li>▶ Purtați mănuși de protecție.</li></ul>

	<b>⚠️ ATENȚIONARE</b>
	<b>Pericol din cauza pieselor care cad pentru că șuruburile sunt slăbite!</b> Accidente din cauza pieselor care cad. <ul style="list-style-type: none"><li>▶ Fixați componenta împotriva căderii.</li></ul>

	<b>ATENȚIE!</b>
	<b>Pericol din cauza pieselor care cad pentru că șuruburile sunt slăbite!</b> Deteriorarea altor piese ale aparatului sau a casei clientului, de exemplu, partea de jos. <ul style="list-style-type: none"><li>▶ Fixați componenta împotriva căderii.</li></ul>

### Cerință:

- ✔️ Aparatul este deconectat de la sursa de energie electrică.
- ✔️ Ușa piesei de mobilier și ușa aparatului sunt separate. Consultați Instrucțiunile de montare.

## 4.3.1 Demontarea balamalei glisante

1. Deșurubați două șuruburi (1).
2. Demontați balamaua de sus a ușii de sus (2).
3. Demontați ușa de sus (3).
4. Deșurubați două șuruburi (4).
5. Demontați balamaua de sus a ușii de jos (5).
6. Demontați ușa de jos (6).

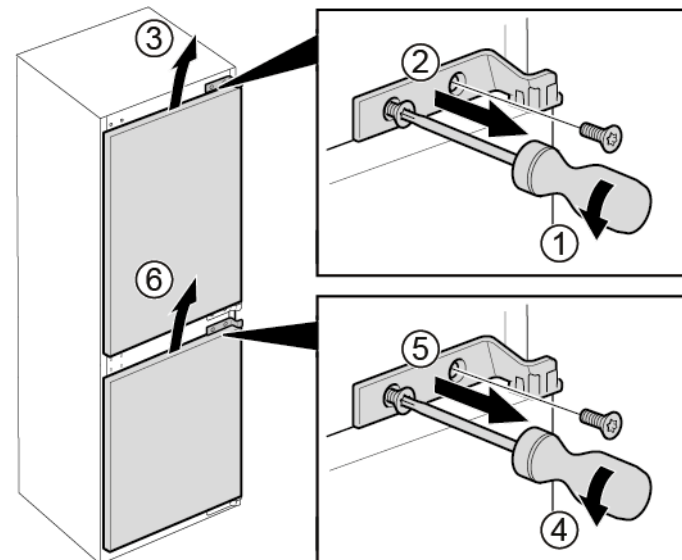

## Repararea

2. 1. Demontați patru șuruburi (1).
2. Demontați balamalele de jos (2).

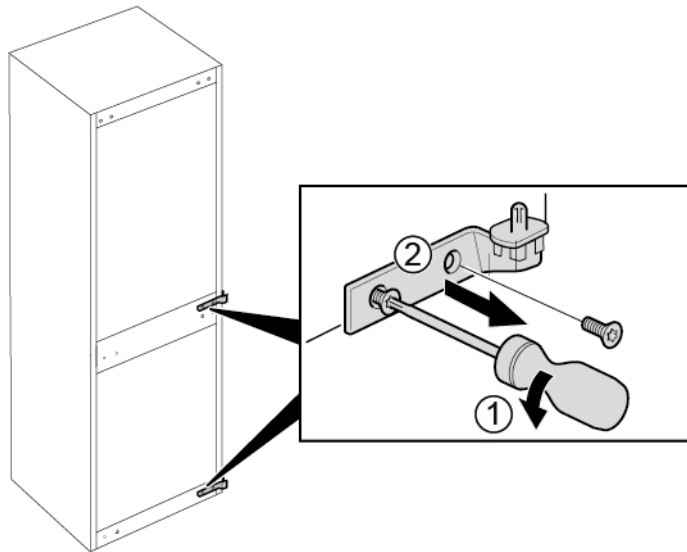

 Balamalele sunt demontate.

### 4.3.2 Montarea balamalei glisante

- ▶ Montați urmând procedura de demontare în ordine inversă.

### 4.4 Repoziționarea raftului pentru ușă

#### Cerință:

- ✔ Ușa este deschisă.

#### 4.4.1 Demontarea raftului pentru ușă

- ▶ Ridicați raftul pentru ușă.

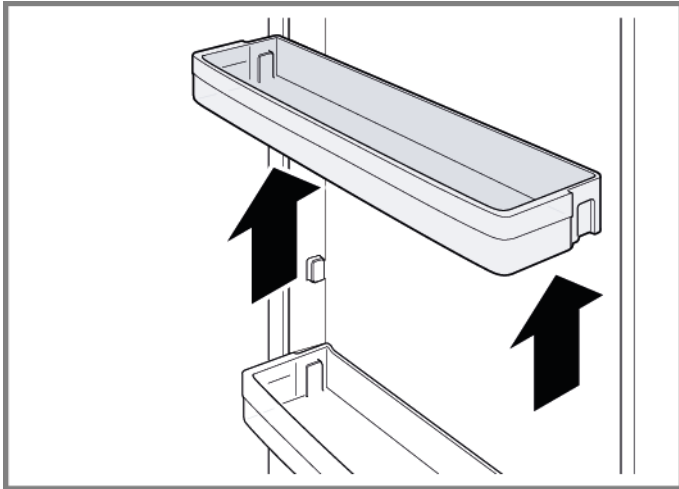

- ➡ Raftul pentru ușă este demontat.

#### 4.4.2 Montarea raftului pentru ușă

- ▶ Montați urmând procedura de demontare în ordine inversă.

## 4.5 Repoziționarea raftului

### Cerință:

- ✔ Ușa este deschisă.

### 4.5.1 Demontarea raftului

- ▶ Scoateți raftul.

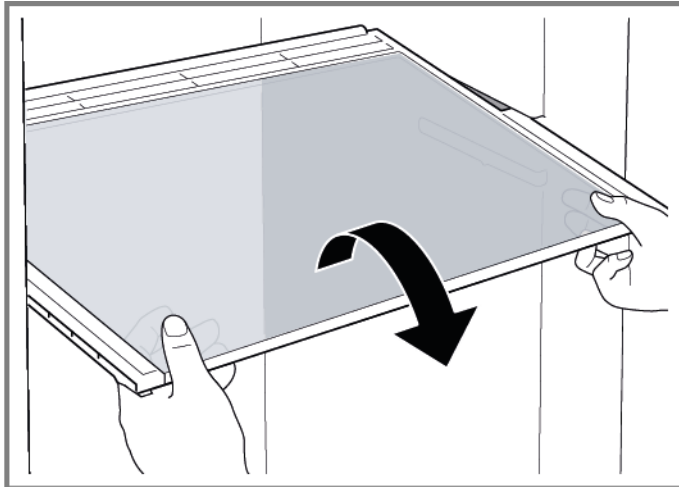

- ➡ Raftul este demontat.

### 4.5.2 Montarea raftului

- ▶ Montați urmând procedura de demontare în ordine inversă.



## 4.6 Repoziționarea raftului extensibil

Cerință:

- ✓ Ușa este deschisă.

### 4.6.1 Demontarea raftului extensibil

1. Trageți afară raftul extensibil până când blocatorul se decuplează.

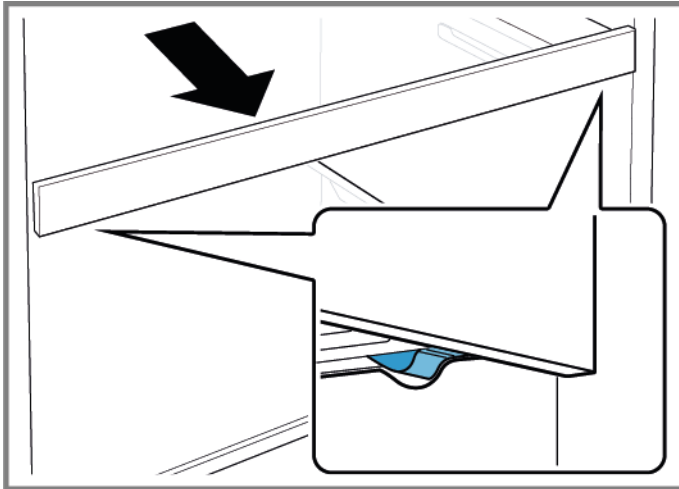

2. Coborâți raftul extensibil și scoateți-l afară înclinându-l pe o parte.
3. ➡ Raftul extensibil este demontat.

### 4.6.2 Montarea raftului extensibil

- ▶ Montați urmând procedura de demontare în ordine inversă.

## 4.7 Repoziționarea raftului din compartimentul congelatorului

### Cerință:

- ✔ Ușa este deschisă.

### 4.7.1 Demontarea raftului din compartimentul congelatorului

- ▶ Trageți afară raftul din compartimentul congelatorului.

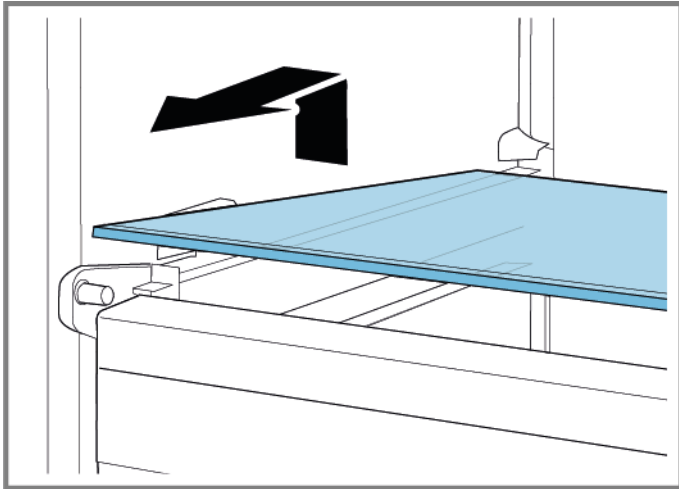

- ➡ Raftul din compartimentul congelatorului este demontat.

### 4.7.2 Montarea raftului din compartimentul congelatorului

- ▶ Montați urmând procedura de demontare în ordine inversă.

## 4.8 Repoziționarea containerului pentru alimente înghețate

### Cerință:

- ✔ Ușa este deschisă.

### 4.8.1 Demontarea containerului pentru alimente înghețate

- ▶ 1. Extrageți complet containerul pentru alimente înghețate (1).
- ▶ 2. Scoateți containerul pentru alimente înghețate (2).

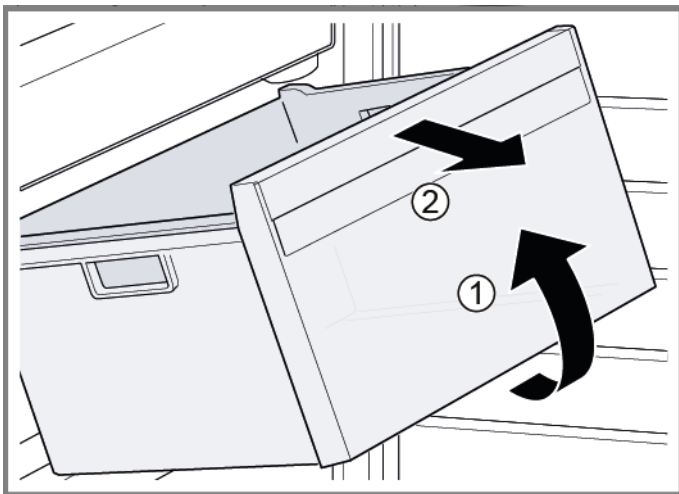

- ➡ Containerul pentru alimente înghețate este demontat.

### 4.8.2 Montarea containerului pentru alimente înghețate

- ▶ Montați urmând procedura de demontare în ordine inversă.

### 4.9 Repoziționarea containerului pentru fructe și legume

#### Cerință:

- ✔ Ușa este deschisă.

#### 4.9.1 Demontarea containerului pentru fructe și legume

- ▶ 1. Extrageți containerul complet (1).
- ▶ 2. Scoateți containerul (2).

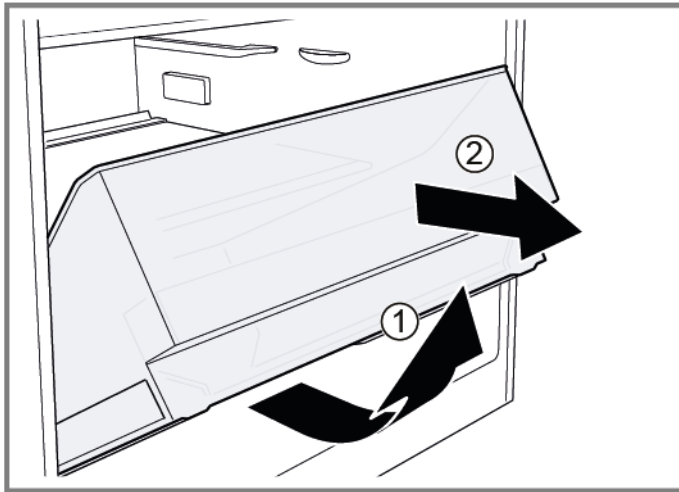

- ➡ Containerul este demontat.

#### 4.9.2 Montarea containerului pentru fructe și legume

- ▶ Montați urmând procedura de demontare în ordine inversă.

### 4.10 Repoziționarea separatorului și a capacului containerului pentru fructe și legume

#### Cerință:

- ✓ Ușa este deschisă.

#### 4.10.1 Demontarea separatorului și a capacului containerului pentru fructe și legume

1. Îndepărtați placa de sticlă de pe separator.

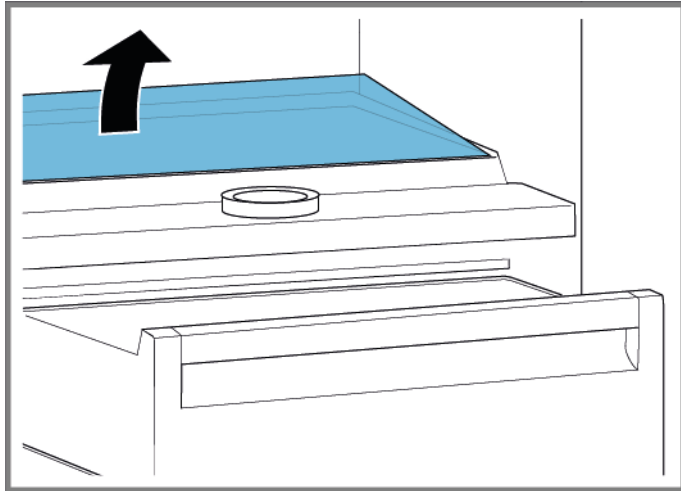

2. [Scoateți containerul pentru fructe și legume. →452](#)

3. 1. Apăsați maneta prezentă pe ambele părți laterale de pe fața inferioară a separatorului (1).
2. Trageți separatorul în sus (2).

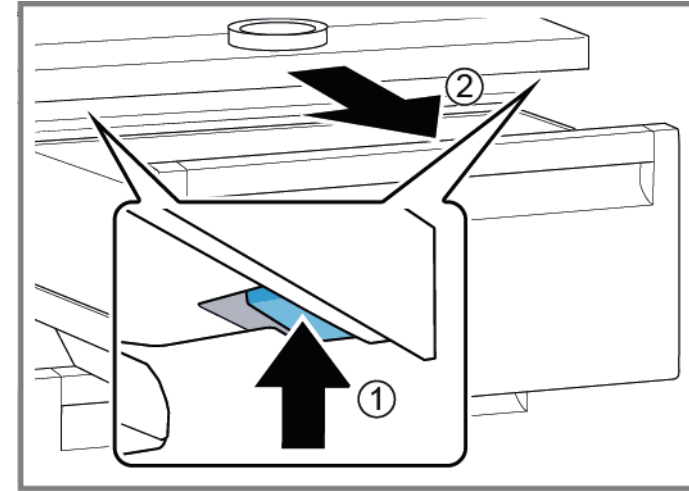

4. Ridicați separatorul și scoateți-l răsucindu-l pe o parte.  
➡ Separatorul este demontat.
5. 1. Ridicați capacul containerului pentru fructe și legume.  
2. Trageți capacul containerului pentru fructe și legume în față și scoateți-l răsucindu-l pe o parte.  
➡ Capacul containerului pentru fructe și legume este demontat.

#### 4.10.2 Montarea separatorului și a capacului containerului pentru fructe și legume

- ▶ Montați urmând procedura de demontare în ordine inversă.

## 4.11 Repoziționarea containerului pentru alimente proaspete

### Cerință:

- ✔ Ușa este deschisă.

### 4.11.1 Demontarea containerului pentru alimente proaspete

- ▶ 1. Înclinați containerul pentru alimente proaspete în față (1).
- ▶ 2. Scoateți containerul pentru alimente proaspete (2).

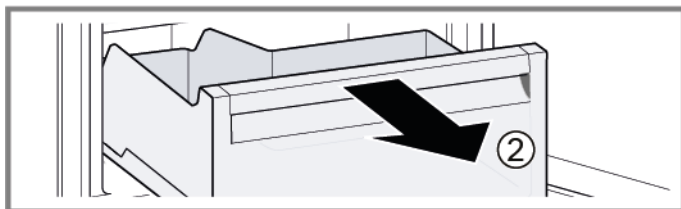
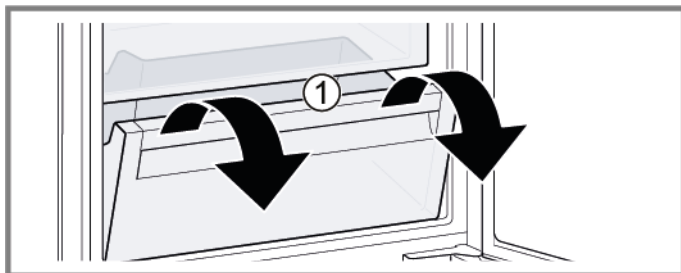

- ➡ Compartimentul pentru alimente proaspete este demontat.

### 4.11.2 Montarea containerului pentru alimente proaspete

- ▶ Montați urmând procedura de demontare în ordine inversă.

## 4.12 Repoziționarea containerului extensibil

### Cerință:

- ✓ Ușa este deschisă.

### 4.12.1 Demontarea containerului extensibil

- ▶ 1. Înclinați containerul extensibil în față (1).
- ▶ 2. Demontați containerul extensibil (2).

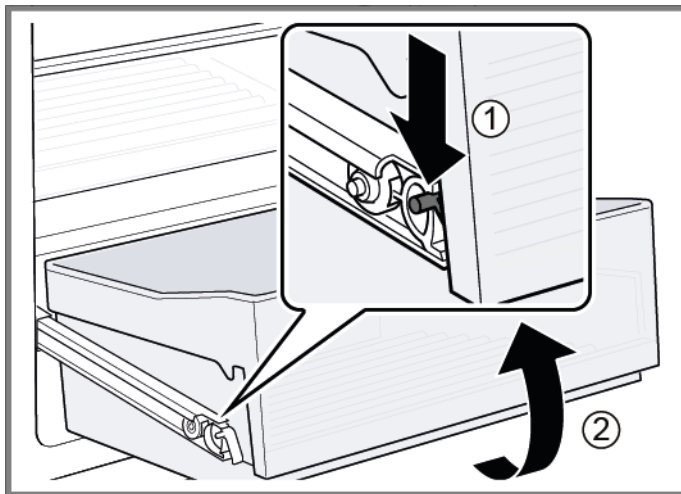



- ➡ Containerul extensibil este demontat.

### 4.12.2 Montarea containerului extensibil

- ▶ Montați urmând procedura de demontare în ordine inversă.

## 4.13 Înlocuirea spotului luminos LED

### Scule speciale:

-  Instrument special [00342180]
-  Șurubelniță plată Lamă de 2,4 mm x 0,4 mm x 60 mm, în kitul [00341820]



Aparatul dumneavoastră este echipat cu o lampă LED care nu necesită întreținere.  
Acele lămpi pot fi înlocuite numai de către departamentul de service pentru clienți sau de către tehnicieni autorizați!



### PERICOL

#### Pericol de electrocutare din cauza pieselor sub tensiune!

Pericol de moarte prin electrocutare în cazul unei reparații necorespunzătoare

- ▶ Componentele electrice trebuie reparate de către electricieni calificați.
- ▶ După reparație, este obligatorie efectuarea unei verificări de siguranță conform cu VDE 0701 sau cu reglementările naționale respective.



### PERICOL

#### Pericol de electrocutare din cauza pieselor sub tensiune!

Deces prin electrocutare

- ▶ Deconectați aparatele de la sursa de alimentare cu tensiune cu cel puțin 60 de secunde înainte de a începe reparațiile.





### ATENȚIONARE

#### Marginea ascuțite!

Rănire prin tăiere

- ▶ Purtați mănuși de protecție.

### Cerință:

-  Aparatul este deconectat de la sursa de energie electrică.
-  Ușa este deschisă.
-  Rafturile din compartimentul frigiderului sunt demontate.

### 4.13.1 Demontarea spotului luminos LED

1. Eliberați capacul spotului luminos LED.

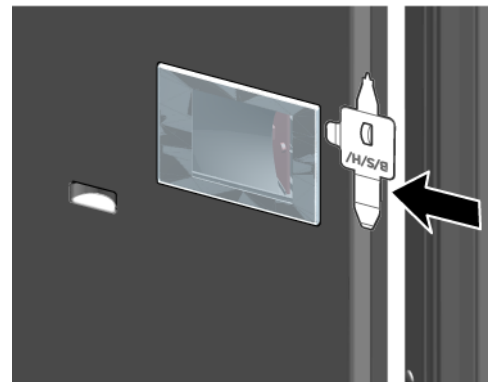

2. Trageți capacul spotului luminos LED în interior și simultan împingeți-l în față.

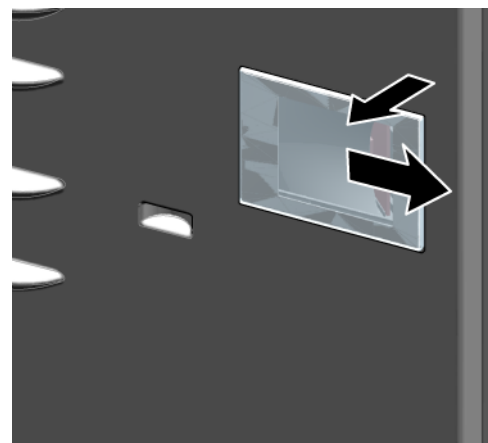



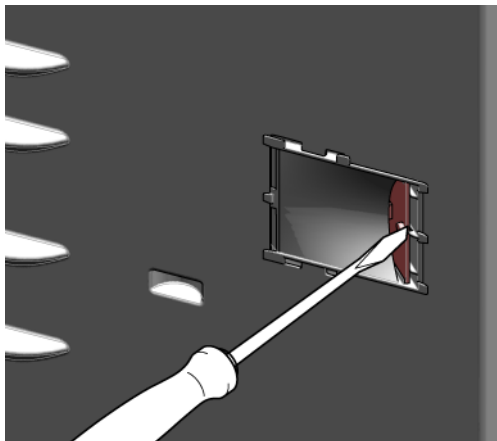

## Repararea

3. Detașați modulul spotului luminos LED.

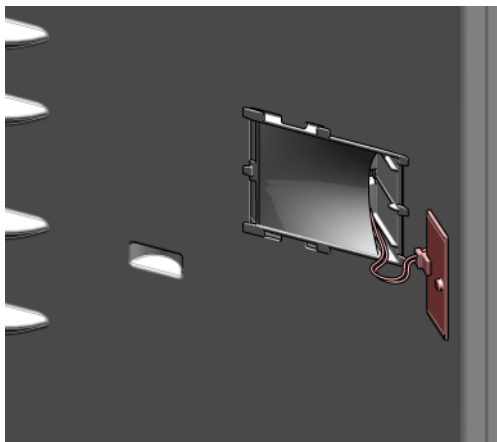

4. Deconectați conexiunea electrică a spotului luminos LED.







-  Sportul luminos LED este demontat.

### 4.13.2 Montarea spotului luminos LED

- ▶ Montați urmând procedura de demontare în ordine inversă.

# Poznámky k opravám - Kombinácia chladničky a mrazničky

 <b>O tomto dokumente</b> .....	<b>459</b>	4.8	Výmena nádoby na zmrazené potraviny .....	475
1.1 Dôležité informácie .....	459	4.8.1	Odobratie nádoby na zmrazené potraviny .....	475
1.1.1 Účel .....	459	4.8.2	Montáž nádoby na zmrazené potraviny .....	475
1.2 Vysvetlenie symbolov .....	459	4.9	Výmena nádoby na ovocie a zeleninu .....	476
1.2.1 Úrovne nebezpečenstva .....	459	4.9.1	Odobratie nádoby na ovocie a zeleninu .....	476
1.2.2 Symboly označujúce riziká .....	459	4.9.2	Montáž nádoby na ovocie a zeleninu .....	476
1.2.3 Štruktúra varovaní .....	460	4.10	Výmena priehradky a krytu nádoby na ovocie a zeleninu .....	477
1.2.4 Všeobecné symboly .....	460	4.10.1	Odobratie priehradky a krytu nádoby na ovocie a zeleninu .....	477
4.10.2	477	4.10.2	Montáž priehradky a krytu nádoby na ovocie a zeleninu .....	477
 <b>Bezpečnosť</b> .....	<b>461</b>	4.11	Výmena nádoby cool-fresh .....	478
2.1 Všeobecné bezpečnostné pokyny .....	461	4.11.1	Odobratie nádoby cool-fresh .....	478
2.1.1 Všetky domáce spotrebiče .....	461	4.11.2	Montáž nádoby cool-fresh .....	478
 <b>Nástroje a pomôcky</b> .....	<b>462</b>	4.12	Výmena výsuvnej nádoby .....	479
 <b>Oprava</b> .....	<b>463</b>	4.12.1	Odobratie výsuvnej nádoby .....	479
4.1 Výmena tesnenia dvierok .....	463	4.12.2	Montáž výsuvnej nádoby .....	479
4.1.1 Odoberanie tesnenia dvierok .....	463	4.13	Výmena bodového LED svetla .....	480
4.1.2 Montáž tesnenia dvierok .....	463	4.13.1	Odoberanie bodového LED svetla .....	480
4.2 Výmena plochého závesu .....	466	4.13.2	Montáž bodového LED svetla .....	481
4.2.1 Odobratie plochého závesu .....	466			
4.2.2 Montáž plochého závesu .....	468			
4.3 Výmena posuvného závesu .....	469			
4.3.1 Odobratie posuvného závesu .....	469			
4.3.2 Montáž posuvného závesu .....	470			
4.4 Výmena poličky v dvierkach .....	471			
4.4.1 Odobratie poličky v dvierkach .....	471			
4.4.2 Montáž poličky do dvierok .....	471			
4.5 Výmena odkladacej plochy .....	472			
4.5.1 Odobratie odkladacej plochy .....	472			
4.5.2 Montáž odkladacej plochy .....	472			
4.6 Výmena výsuvnej police .....	473			
4.6.1 Odobratie výsuvnej police .....	473			
4.6.2 Montáž výsuvnej police .....	473			
4.7 Výmena police mraziaceho priestoru .....	474			
4.7.1 Odobratie police mraziaceho priestoru .....	474			
4.7.2 Montáž police mraziaceho priestoru .....	474			

# **i** O tomto dokumente

## 1.1 Dôležité informácie

### 1.1.1 Účel

Tieto pokyny pre opravu pomáhajú spotrebiteľovi pri vlastnej oprave spotrebičov podľa nariadenia o ekodizajne (z marca 2021).

Obsahujú informácie o výmene určených náhradných dielov vrátane varovaní a rizík.

Ak máte otázky, kontaktujte náš zákaznícky servis. Za poškodenia ručíme len vtedy, ak pokyny boli dodržané správne.

## 1.2 Vysvetlenie symbolov

### 1.2.1 Úrovne nebezpečenstva

Úroveň varovania obsahuje symbol a signalizačné slovo. Signalizačné slovo naznačuje mieru nebezpečenstva.





Úroveň varovania	Význam
 <b>NEBEZPEČENSTVO</b>	Následkom nerešpektovania varovného hlásenia je úmrtie alebo vážne zranenia.
 <b>VAROVANIE</b>	Možným následkom nerešpektovania varovného hlásenia je úmrtie alebo vážne zranenia.
 <b>UPOZORNENIE</b>	Možným následkom nerešpektovania varovného hlásenia sú mierne zranenia.
 <b>POZOR!</b>	Možným následkom nerešpektovania varovného hlásenia je poškodenie majetku.

Tabuľka 1: Úrovne nebezpečenstva



### 1.2.2 Symboly označujúce riziká

Symboly označujúce riziká sú symbolické znázornenia, ktoré naznačujú druh nebezpečenstva.

V tomto dokumente sa používajú nasledujúce symboly označujúce riziká:

Symbol označujúci riziko	Význam
	Všeobecné varovné hlásenie
	Nebezpečenstvo v súvislosti s elektrickým napätím
	Nebezpečenstvo výbuchu
	Nebezpečenstvo porezania
	Nebezpečenstvo pomliaždenia

## **i** O tomto dokumente

Symbol označujúci riziko	Význam
	Nebezpečenstvo v súvislosti s horúcimi povrchmi
	Nebezpečenstvo v súvislosti s magnetickým poľom
	Nebezpečenstvo v súvislosti s neionizujúcou radiáciou

Tabuľka 2: Symboly označujúce riziká

### 1.2.3 Štruktúra varovaní

Varovania v tomto dokumente majú štandardný vzhľad a štandardnú štruktúru.



	<p><b>⚠ NEBEZPEČENSTVO</b></p> <p><b>Druh a zdroj nebezpečenstva!</b> Možné následky pri ignorovaní nebezpečenstva/varovania.</p> <ul style="list-style-type: none"> <li>▶ Opatrenia a zákazy na zabránenie nebezpečenstvu.</li> </ul>
--	--





Nasledujúci príklad znázorňuje varovanie pred zásahom elektrickým prúdom pri dotyku s časťami pod napätím. Je uvedené opatrenie na predídenie nebezpečenstvu.

	<p><b>⚠ NEBEZPEČENSTVO</b></p> <p><b>Nebezpečenstvo úrazu elektrickým prúdom pri dotyku s časťami pod napätím!</b> Úmrtie v dôsledku zásahu elektrickým prúdom</p> <ul style="list-style-type: none"> <li>▶ Odpojte spotrebiče od elektrického zdroja aspoň 60 sekúnd pred začiatkom opráv.</li> </ul>
---	--

### 1.2.4 Všeobecné symboly

V tomto dokumente sa používajú nasledujúce všeobecné symboly:

Všeob. symbol	Význam
	Označenie špeciálneho pokynu (textové a/alebo grafické)
	Označenie jednoduchého pokynu (len textové)

Všeob. symbol	Význam
	Označenie prepojenia na videonávod
	Označenie požadovaných nástrojov
	Označenie požadovaných podmienok
	Označenie podmienky (ak ..., potom ...)
	Označenie výsledku
[Spustenie]	Označenie klávesu alebo tlačidla
[00123456]	Označenie čísla materiálu
Stav	Označenie zobrazeného textu/okna (na displeji spotrebiča)

Tabuľka 3: Všeobecné symboly

## **2.1 Všeobecné bezpečnostné pokyny**

### **2.1.1 Všetky domáce spotrebiče**

#### **Nebezpečenstvo úrazu elektrickým prúdom pri dotyku s časťami pod napätím!**

- Chyby pri opravách na elektrických komponentoch môžu spôsobiť zásah elektrickým prúdom!
- Odpojte spotrebič od elektrickej siete aspoň 60 sekúnd pred začiatkom práce.
- Po oprave zariadenia vykonajte bezpečnostný test v súlade s nariadením VDE 0701 alebo s miestnymi nariadeniami.

#### **Riziko poranenia na ostrých hranách!**

- Noste ochranné rukavice.

#### **Riziko pomliaždenia počas opravy, údržby, riešenia problémov a servisu na ťažkých a pohybujúcich sa komponentoch**

- Noste ochrannú obuv.
- Zaisťte ťažké komponenty proti pádu.
- Nesiahajte končatinami do pohybujúcich sa komponentov.



#### **Riziko ohrozenia bezpečnosti/funkčnosti spotrebiča!**

- Používajte len originálne náhradné diely.

#### **Riziko poškodenia elektrostaticky citlivých komponentov (ESD)!**

- Nedotýkajte sa modulov vrátane prípojok a vedení vodičov.

## Nástroje a pomôcky

Označenie	Detaily	Snímky
Ochranná látka [00342013]	60 cm x 50 cm	
Bit Torx TX20 [00340865]	6,3 mm (1/4")	
Špeciálny nástroj [00342180]		

## 4.1 Výmena tesnenia dvierok

### Požiadavka:

- ✔ Dvierka sú otvorené.

### 4.1.1 Odoberanie tesnenia dvierok

1. Uvoľnite tesnenie dvierok z drážky na pravom a ľavom rohu.

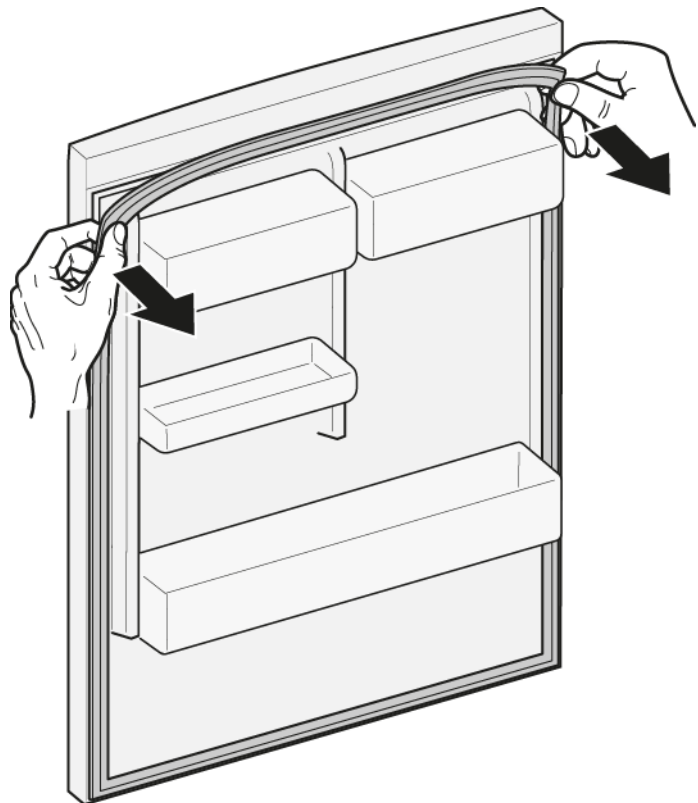

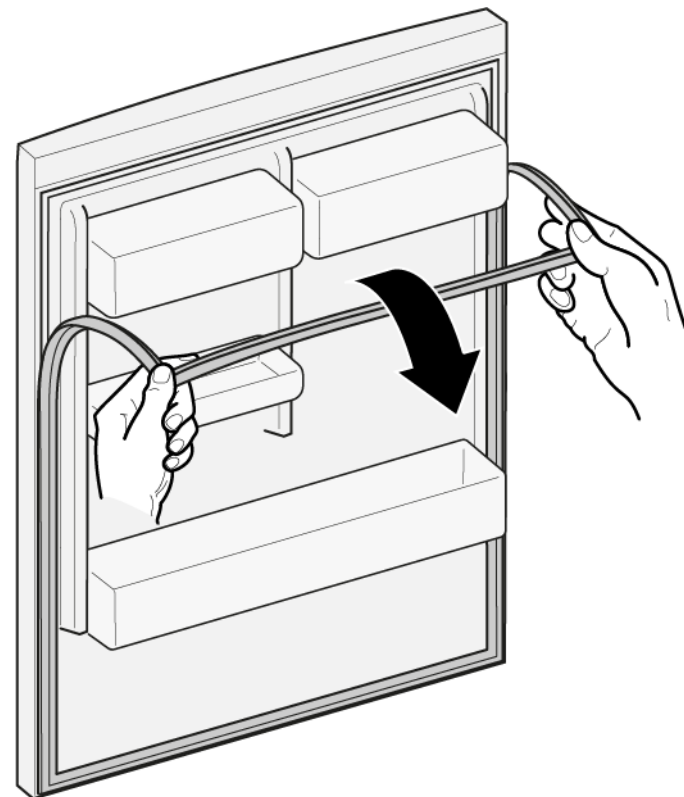

2. Vytiahnite tesnenie z drážky.



- ➡ Tesnenie dvierok je odobraté.

### 4.1.2 Montáž tesnenia dvierok

	Hrúbka nového tesnenia dvierok sa môže mierne odlišovať od hrúbky starého tesnenia dvierok. Neovplyvní to zatváranie ani funkčnosť z dlhodobého hľadiska.
	Ak má váš spotrebič nastaviteľné závesy alebo závesové úchytky, postupne môžete optimalizovať spôsob zatvárania.
	Malé bočné diery v tesnení dvierok majú svoju funkciu (sú potrebné na vetranie). Nie sú výrobnou chybou.

1. Skontrolujte poškodenie drážky na tesnenie.

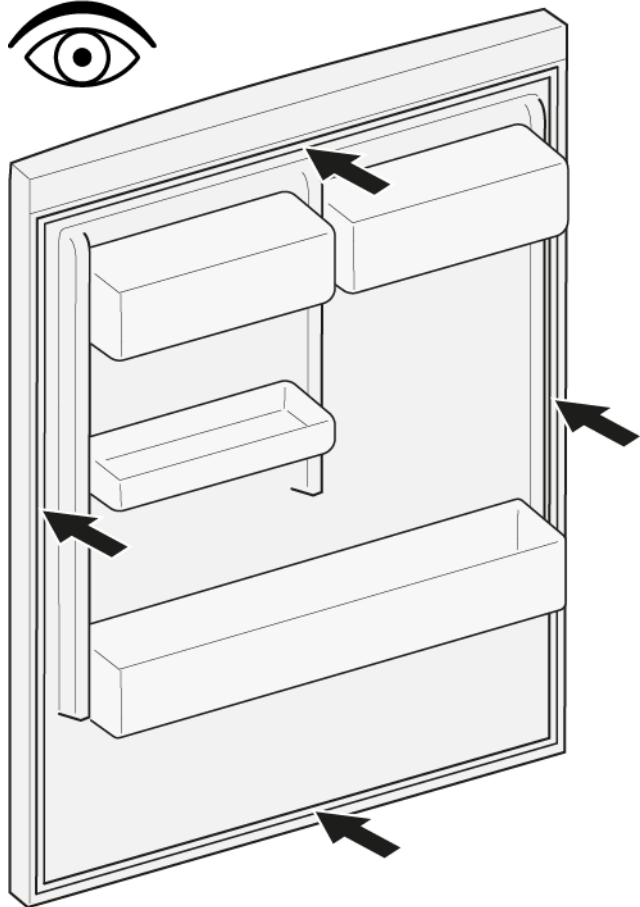

4. Hore a dole vtláčte rohy tesnenia do drážky.

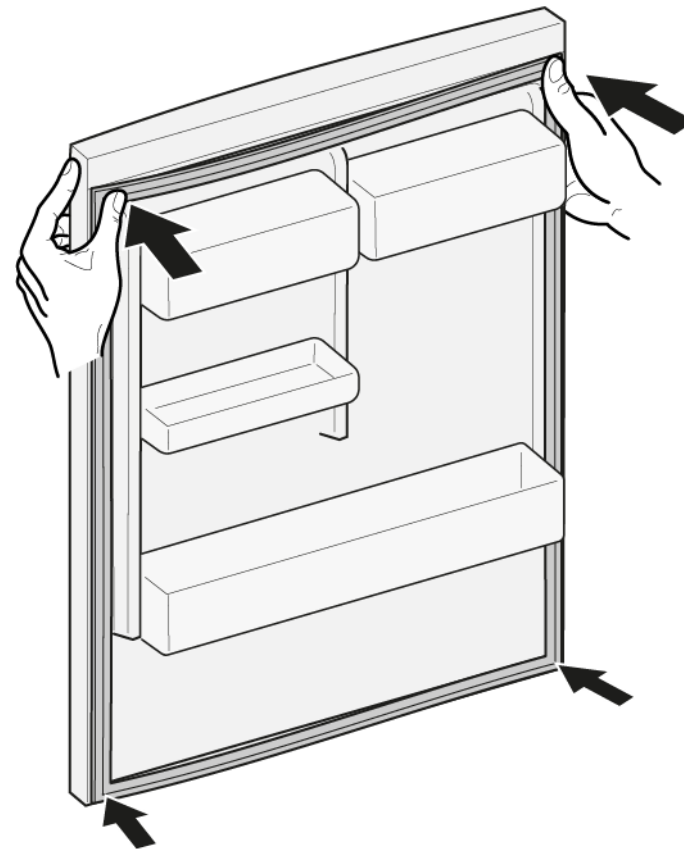

2.  Ak je drážka tesnenia je poškodená.  
- Kontaktujte zákaznícky servis.

3.  Mierna deformácia tesnenia dvierok je normálna a neovplyvňuje jeho funkciu. Odporúča sa vyrovnať tesnenie pred jeho vloženíom do spotrebiča.

Nahrejte tesnenie dvierok použitím fénu alebo horúcej vody a manuálne ho vytvarujte.



5. Jedno miesto po druhom vtlačte celé tesnenie do drážky.

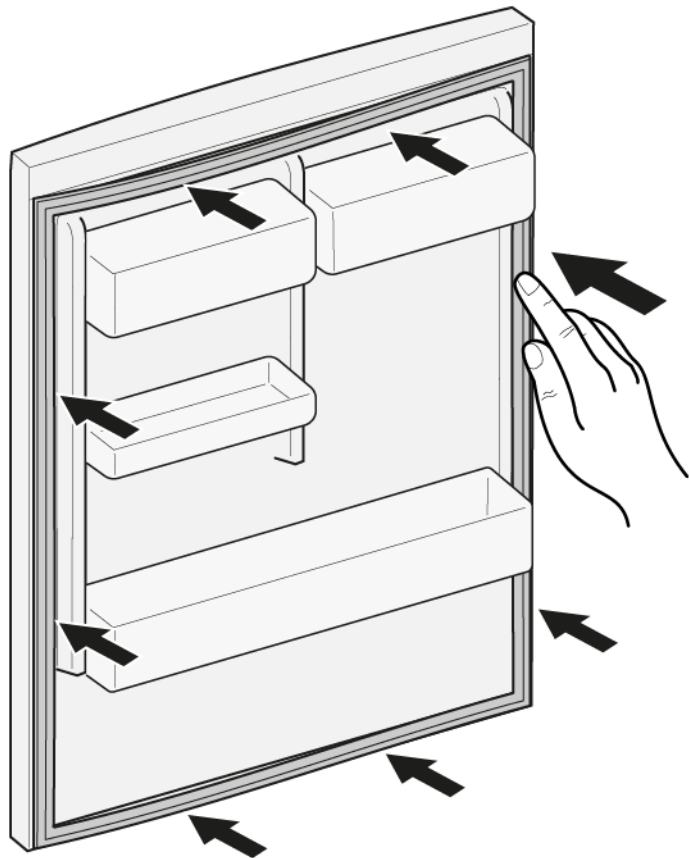

-  Tesnenie dvierok je namontované.

## 4.2 Výmena plochého závesu

Špeciálne nástroje:

 Bit Torx TX20

6,3 mm (1/4")

[00340865]

	<b>VAROVANIE</b>
	<p><b>Ťažké, objemné spotrebiče!</b> Poranenie chrbta a svalov</p> <ul style="list-style-type: none"> <li>▶ Proces odobrania dvierok spotrebiča by mal vykonávať školený odborník.</li> <li>▶ Na presunutie spotrebiča sa vyžadujú dve osoby.</li> <li>▶ Použite vhodné nástroje a vybavenie.</li> </ul>



	<b>UPOZORNENIE</b>
	<p><b>Ostré hrany!</b> Rezné poranenia</p> <ul style="list-style-type: none"> <li>▶ Noste ochranné rukavice.</li> </ul>

	<b>UPOZORNENIE</b>
	<p><b>Otvorte oblasť závesov!</b> Pomliaždenie/zachytenie prstov</p> <ul style="list-style-type: none"> <li>▶ Nesiahajte do priestoru závesov.</li> <li>▶ Noste ochranné rukavice.</li> </ul>

	<b>UPOZORNENIE</b>
	<p><b>Riziko pádu dielov po uvoľnení skrutiek!</b> Zranenie padajúcimi dielmi.</p> <ul style="list-style-type: none"> <li>▶ Zaistite komponent proti pádu.</li> </ul>

	<b>POZOR!</b>
	<p><b>Riziko pádu dielov po uvoľnení skrutiek!</b> Poškodenie iných častí spotrebiča alebo domácnosti zákazníka, napr. podlahy.</p> <ul style="list-style-type: none"> <li>▶ Zaistite komponent proti pádu.</li> </ul>

Požiadavka:

-  Spotrebič je odpojený od elektrického napájania.
-  Dvierka nábytku sú odobraté. Prečítajte si návod na montáž.
-  Dvierka sú otvorené.

### 4.2.1 Odobratie plochého závesu

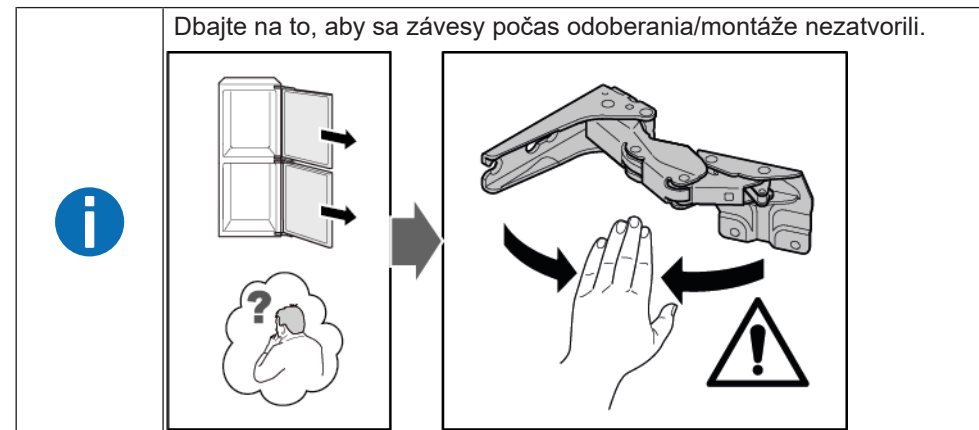

1. Odoberte štyri kryty závesu.

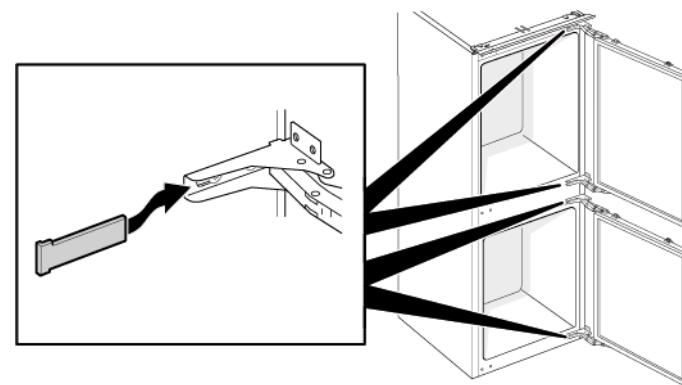

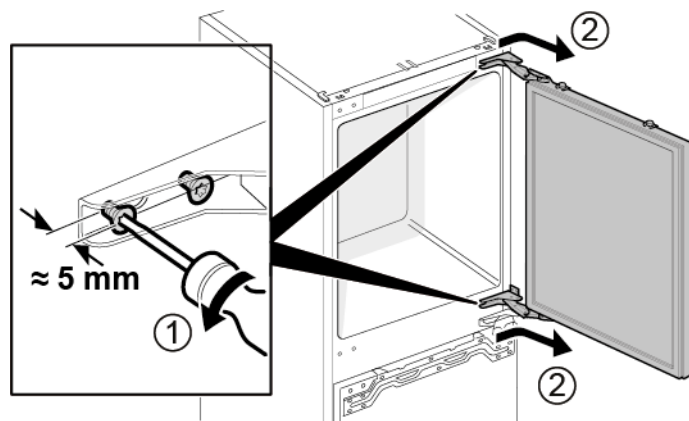

## Oprava

2. 1. Uvoľnite štyri skrutky (1).  
2. Vysuňte a odoberte horné dvierka (2).

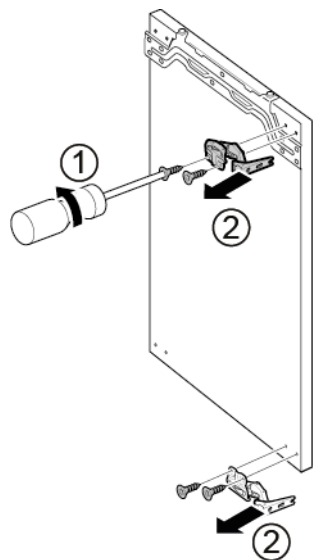

3. 1. Odoberte štyri skrutky (1).  
2. Odoberte závesy (2).



 Závesy horných dvierok sú odobraté.

4. 1. Uvoľnite štyri skrutky (1).  
2. Vysuňte a odoberte spodné dvierka (2).

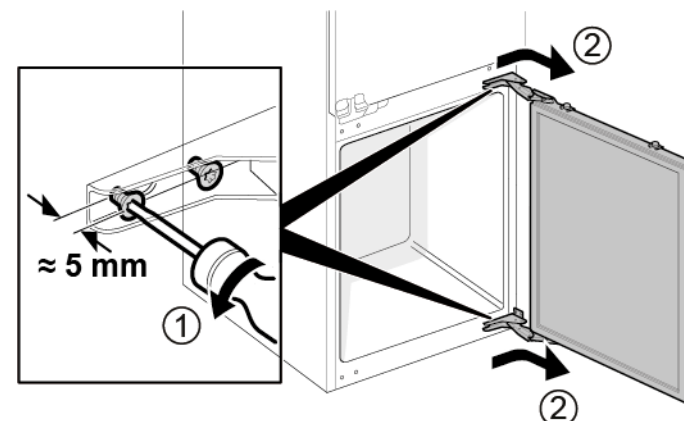

5. 1. Odoberte štyri skrutky (1).  
2. Odoberte závesy (2).

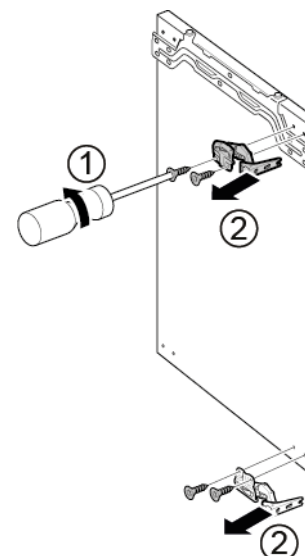

 Závesy spodných dvierok sú odobraté.

#### **4.2.2 Montáž plochého závesu**

- ▶ Pri montáži postupujte v opačnom poradí krokov demontáže.

### 4.3 Výmena posuvného závesu

#### Špeciálne nástroje:

 Bit Torx TX20                      6,3 mm (1/4")                      [00340865]



	<b>⚠ VAROVANIE</b>
	<p><b>Ťažké, objemné spotrebiče!</b> Poranenie chrbta a svalov</p> <ul style="list-style-type: none"> <li>▶ Proces odoberania dvierok spotrebiča by mal vykonávať školený odborník.</li> <li>▶ Na presunutie spotrebiča sa vyžadujú dve osoby.</li> <li>▶ Použite vhodné nástroje a vybavenie.</li> </ul>

	<b>⚠ UPOZORNENIE</b>
	<p><b>Ostré hrany!</b> Rezné poranenia</p> <ul style="list-style-type: none"> <li>▶ Noste ochranné rukavice.</li> </ul>

	<b>⚠ UPOZORNENIE</b>
	<p><b>Riziko pádu dielov po uvoľnení skrutiek!</b> Zranenie padajúcimi dielmi.</p> <ul style="list-style-type: none"> <li>▶ Zaistite komponent proti pádu.</li> </ul>

	<b>POZOR!</b>
	<p><b>Riziko pádu dielov po uvoľnení skrutiek!</b> Poškodenie iných častí spotrebiča alebo domácnosti zákazníka, napr. podlahy.</p> <ul style="list-style-type: none"> <li>▶ Zaistite komponent proti pádu.</li> </ul>

#### Požiadavka:

-  Spotrebič je odpojený od elektrického napájania.
-  Dvierka nábytku a dvierka spotrebiča sú oddelené. Prečítajte si návod na montáž.

#### 4.3.1 Odobratie posuvného závesu

1. 1. Odskrutkujte dve skrutky (1).
2. 2. Odoberte horný záves horných dvierok (2).
3. 3. Odoberte horné dvierka (3).
4. 4. Odskrutkujte dve skrutky (4).
5. 5. Odoberte horný záves spodných dvierok (5).
6. 6. Odoberte spodné dvierka (6).

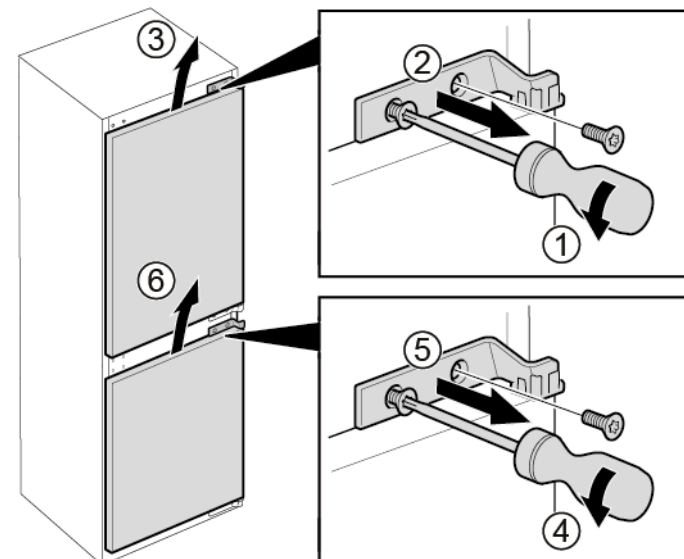

2. 1. Odoberte štyri skrutky (1).
2. Odoberte spodné závesy (2).

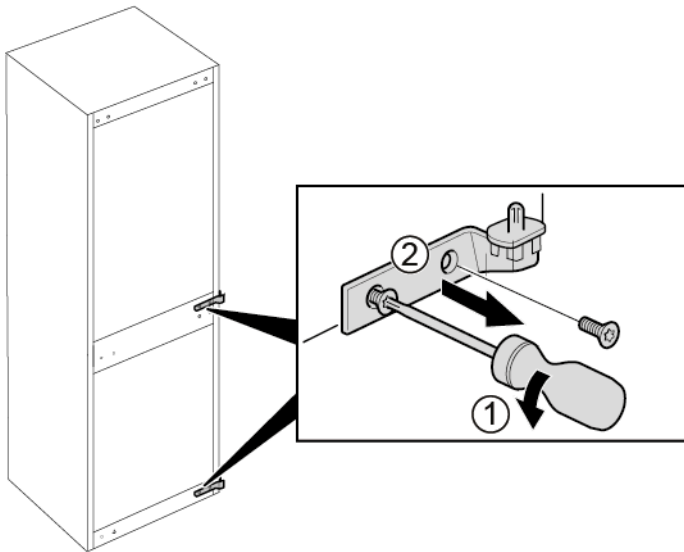

 Závesy sú odobraté.

### 4.3.2 Montáž posuvného závesu

- ▶ Pri montáži postupujte v opačnom poradí krokov demontáže.

## 4.4 Výmena poličky v dvierkach

### Požiadavka:

- ✔ Dvierka sú otvorené.

### 4.4.1 Odobratie poličky v dvierkach

- ▶ Poličku v dvierkach zodvihnite smerom nahor.

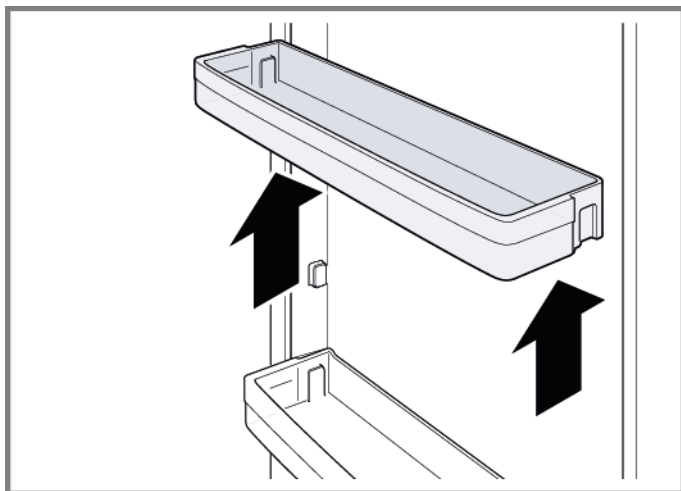

- ➡ Polička v dvierkach je odobratá.

### 4.4.2 Montáž poličky do dvierok

- ▶ Pri montáži postupujte v opačnom poradí krokov demontáže.

## 4.5 Výmena odkladacej plochy

### Požiadavka:

- ✔ Dvierka sú otvorené.

### 4.5.1 Odobratie odkladacej plochy

- ▶ Vytiahnite odkladaciu plochu.

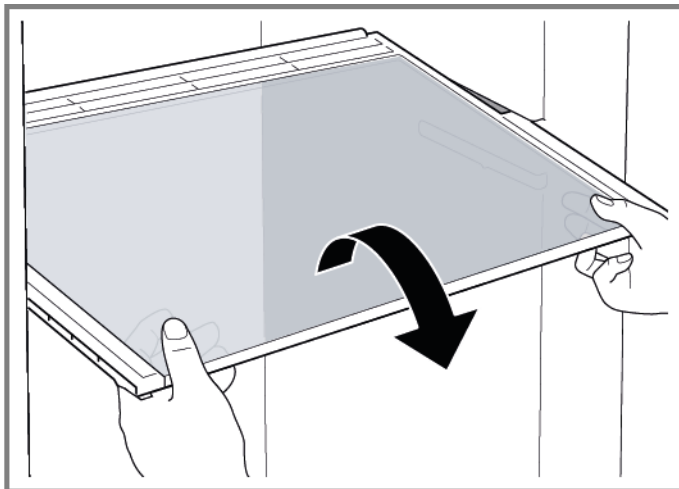

- ➡ Odkladacia plocha je odobratá.

### 4.5.2 Montáž odkladacej plochy

- ▶ Pri montáži postupujte v opačnom poradí krokov demontáže.



## 4.6 Výmena výsuvnej police

### Požiadavka:

- ✔ Dvierka sú otvorené.

### 4.6.1 Odobratie výsuvnej police

1. Vysuňte výsuvnú policu, aby sa uvoľnila blokovacia úchytka.

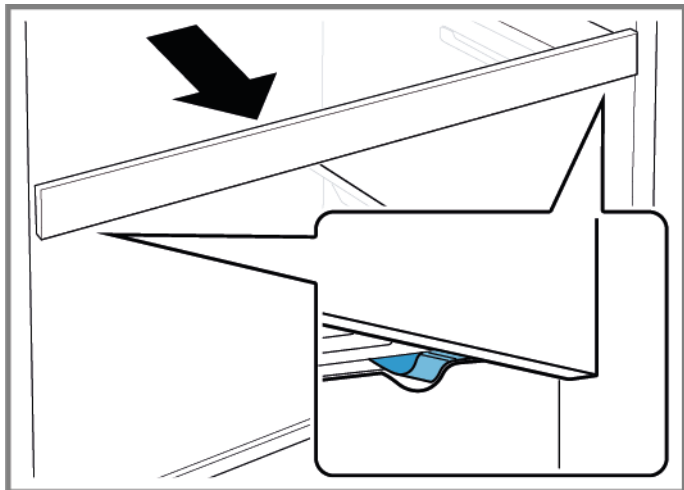

2. Znížte výsuvnú policu a vyklopte ju nabok.
3.  Výsuvná policu je odobratá.

### 4.6.2 Montáž výsuvnej police

- ▶ Pri montáži postupujte v opačnom poradí krokov demontáže.

## 4.7 Výmena police mraziaceho priestoru

### Požiadavka:

- ✔ Dvierka sú otvorené.

### 4.7.1 Odobratie police mraziaceho priestoru

- ▶ Vysuňte policu mraziaceho priestoru.

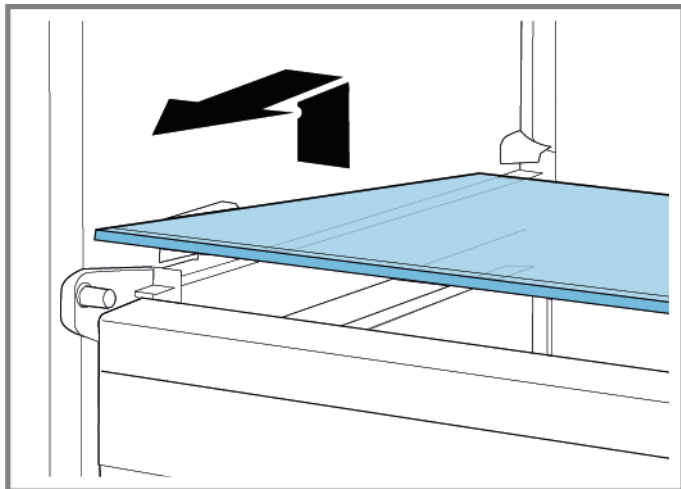

- ➡ Polica mraziaceho priestoru je odobratá.

### 4.7.2 Montáž police mraziaceho priestoru

- ▶ Pri montáži postupujte v opačnom poradí krokov demontáže.

## 4.8 Výmena nádoby na zmrazené potraviny

### Požiadavka:

- ✔ Dvierka sú otvorené.

### 4.8.1 Odobratie nádoby na zmrazené potraviny

- ▶ 1. Úplne vytiahnite nádobu na zmrazené potraviny (1).
- ▶ 2. Odoberte nádobu na zmrazené potraviny (2).

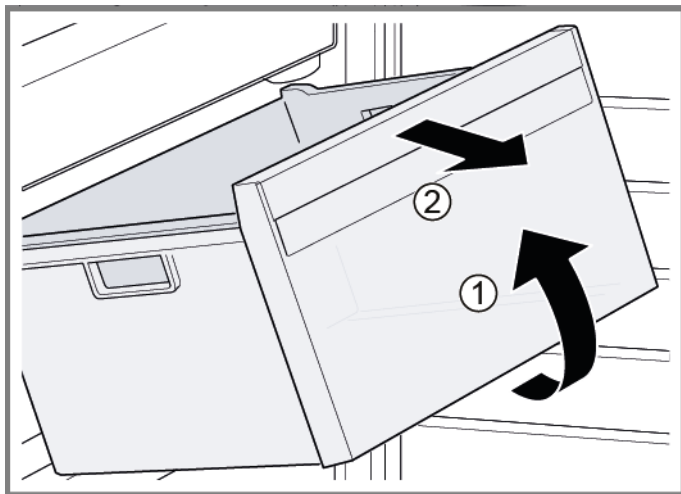

- ➡ Nádobu na zmrazené potraviny je odobratá.

### 4.8.2 Montáž nádoby na zmrazené potraviny

- ▶ Pri montáži postupujte v opačnom poradí krokov demontáže.

## 4.9 Výmena nádoby na ovocie a zeleninu

### Požiadavka:

- ✔ Dvierka sú otvorené.

### 4.9.1 Odobratie nádoby na ovocie a zeleninu

- ▶ 1. Úplne vytiahnite nádobu (1).
- ▶ 2. Odoberte nádobu (2).

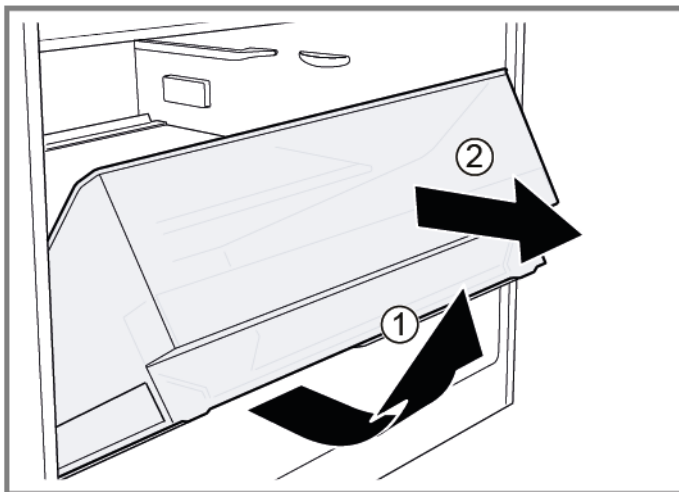

- ➡ Nádoba je odobratá.

### 4.9.2 Montáž nádoby na ovocie a zeleninu

- ▶ Pri montáži postupujte v opačnom poradí krokov demontáže.

## 4.10 Výmena priehradky a krytu nádoby na ovocie a zeleninu

### Požiadavka:

- ✔ Dvierka sú otvorené.

### 4.10.1 Odobratie priehradky a krytu nádoby na ovocie a zeleninu

1. Odoberte sklenenú dosku z priehradky.

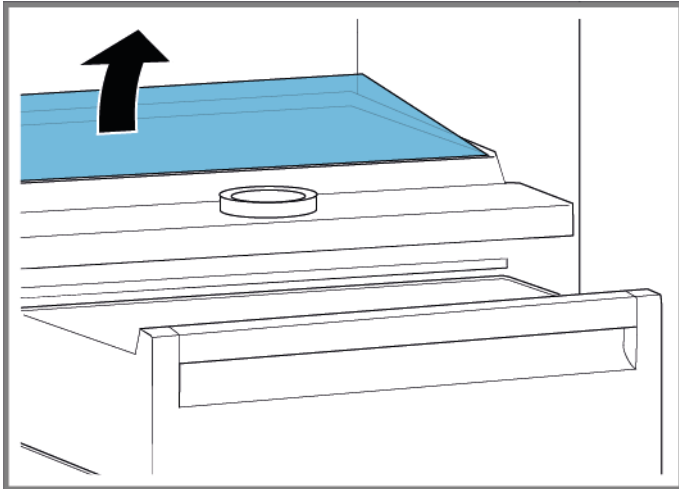

2. [Odoberte nádobu na ovocie a zeleninu.→476](#)

3. 1. Stlačte páčku na spodnej strane oboch strán priehradky (1).
2. Potiahnite priehradku dopredu (2).

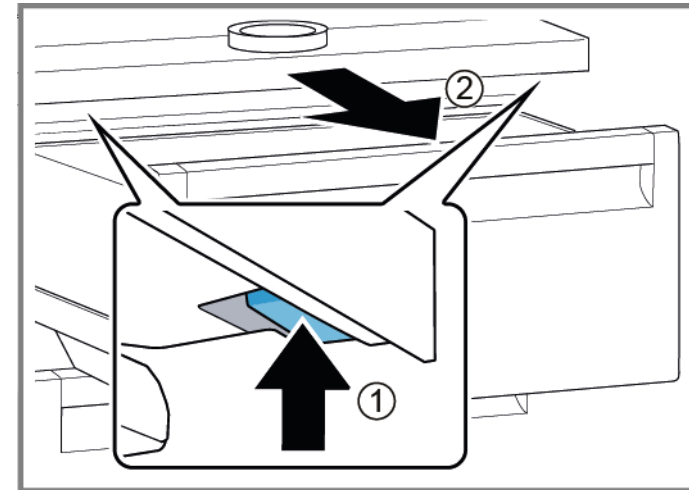

4. Zdvihnite priehradku a vyklopte ju nabok.  
➡ Priehradka je odobratá.
5. 1. Zdvihnite kryt nádoby na ovocie a zeleninu.  
2. Potiahnite kryt nádoby na ovocie a zeleninu dopredu a vyklopte ju nabok.  
➡ Kryt nádoby na ovocie a zeleninu je odobratý.

### 4.10.2 Montáž priehradky a krytu nádoby na ovocie a zeleninu

- ▶ Pri montáži postupujte v opačnom poradí krokov demontáže.

## 4.11 Výmena nádoby cool-fresh

### Požiadavka:

- ✔ Dvierka sú otvorené.

### 4.11.1 Odobratie nádoby cool-fresh

- ▶ 1. Nádobu cool-fresh nakloňte dopredu (1).
- ▶ 2. Odoberte nádobu cool-fresh (2).

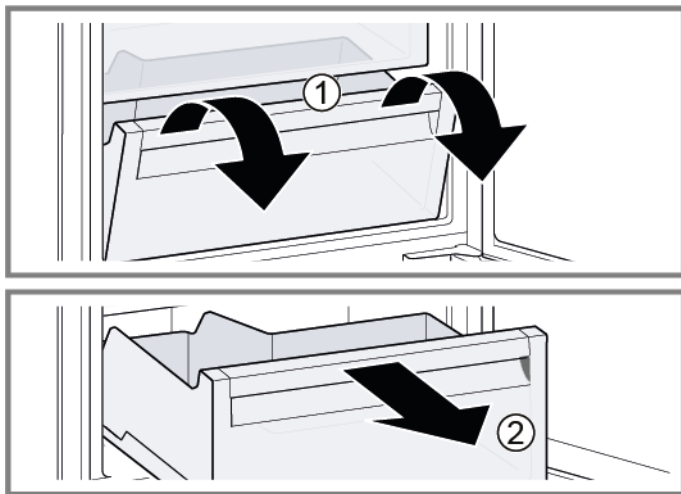

- ➡ Nádobu cool-fresh je odobratá.

### 4.11.2 Montáž nádoby cool-fresh

- ▶ Pri montáži postupujte v opačnom poradí krokov demontáže.

## 4.12 Výmena výsuvnej nádoby

### Požiadavka:

- ✔ Dvierka sú otvorené.

### 4.12.1 Odobratie výsuvnej nádoby

- ▶ 1. Výsuvnú nádobu nakloňte dopredu (1).
- ▶ 2. Odoberte výsuvnú nádobu (2).

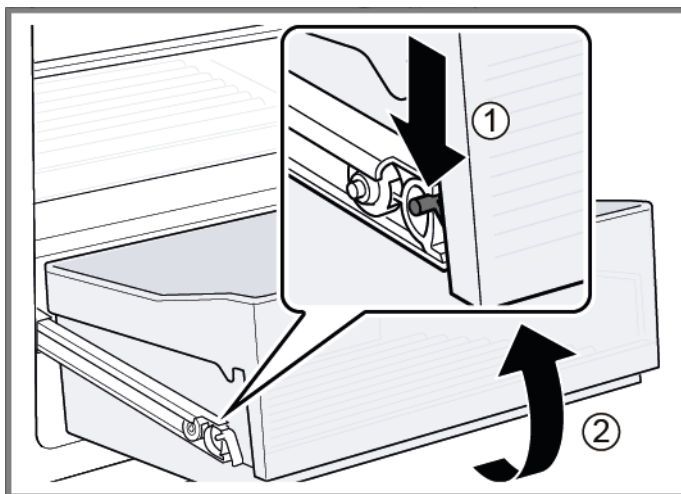



➡ Výsuvná nádoba je odobratá.

### 4.12.2 Montáž výsuvnej nádoby

- ▶ Pri montáži postupujte v opačnom poradí krokov demontáže.

## 4.13 Výmena bodového LED svetla

### Špeciálne nástroje:

-  Špeciálny nástroj [00342180]
-  Plochý skrutkovač Čepel' 2,4 mm x 0,4 mm x 60 mm, v sade [00341820]



	Vo výbave vášho spotrebiča je bezúdržbové LED svetlo. Tieto svetlá môže opravovať len zákaznícky servis alebo oprávnený technik!
---	--

	<b>⚠ NEBEZPEČENSTVO</b>
	<p><b>Nebezpečenstvo úrazu elektrickým prúdom pri dotyku s časťami pod napätím!</b>                  Ohrozenie života spôsobené elektrickým zásahom v prípade nesprávnej opravy</p> <ul style="list-style-type: none"> <li>▶ Elektrické diely má opravovať kvalifikovaný elektrikár.</li> <li>▶ Po oprave zariadenie vykonanie bezpečnostného testu v súlade s nariadením VDE 0701 alebo s miestnymi nariadeniami.</li> </ul>

	<b>⚠ NEBEZPEČENSTVO</b>
	<p><b>Nebezpečenstvo úrazu elektrickým prúdom pri dotyku s časťami pod napätím!</b>                  Úmrtie v dôsledku zásahu elektrickým prúdom</p> <ul style="list-style-type: none"> <li>▶ Odpojte spotrebiče od elektrického zdroja aspoň 60 sekúnd pred začiatkom opráv.</li> </ul>

	<b>⚠ UPOZORNENIE</b>
	<p><b>Ostré hrany!</b>                  Rezné poranenia</p> <ul style="list-style-type: none"> <li>▶ Noste ochranné rukavice.</li> </ul>

### Požiadavka:

-  Spotrebič je odpojený od elektrického napájania.
-  Dvierka sú otvorené.
-  Poličky chladiaceho priestoru sú odobraté.

### 4.13.1 Odoberanie bodového LED svetla

1. Uvoľnite kryt bodového LED svetla.

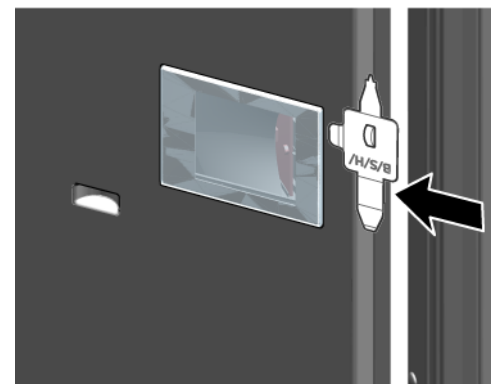

2. Potiahnite kryt bodového LED svetla dovnútra a zároveň zatlačte dopredu.

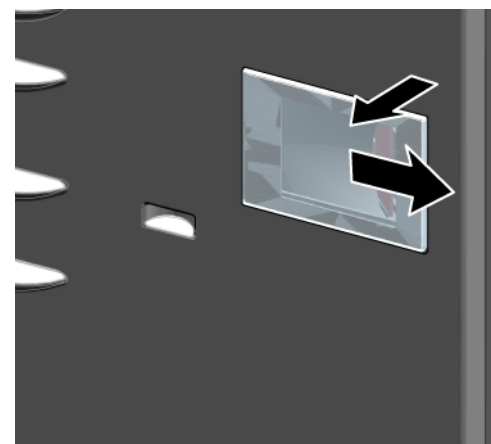



3. Odpojte modul bodového LED svetla.

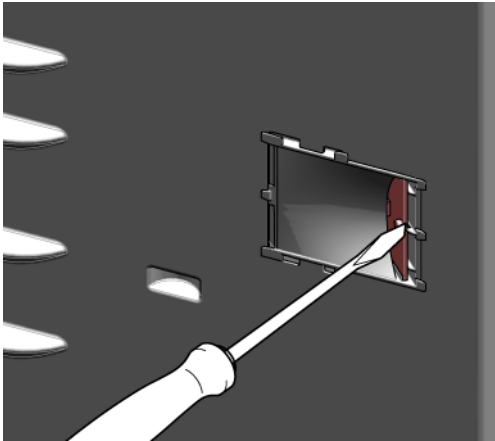

4. Odpojte elektrické pripojenie bodového LED svetla.

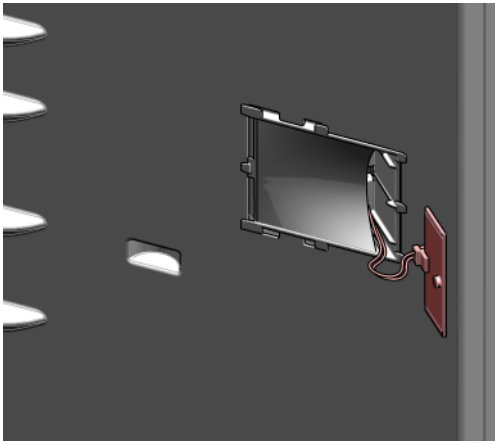





 Bodové LED svetlo je odobraté.

### 4.13.2 Montáž bodového LED svetla

- ▶ Pri montáži postupujte v opačnom poradí krokov demontáže.

# Nasveti za popravilo - Hladilno-zamrzovalna kombinacija

 <b>V zvezi s tem dokumentom</b> .....	<b>483</b>
1.1 Pomembne informacije .....	483
1.1.1 Namen .....	483
1.2 Razlaga simbolov .....	483
1.2.1 Stopnje nevarnosti .....	483
1.2.2 Simboli za nevarnost .....	483
1.2.3 Struktura opozoril .....	484
1.2.4 Splošni simboli .....	484
 <b>Varnost</b> .....	<b>485</b>
2.1 Splošna varnostna navodila .....	485
2.1.1 Vsi gospodinjski aparati .....	485
 <b>Orodja in pripomočki</b> .....	<b>486</b>
 <b>Popravilo</b> .....	<b>487</b>
4.1 Zamenjava tesnila vrat .....	487
4.1.1 Odstranjevanje tesnila vrat .....	487
4.1.2 Namestitev tesnila vrat .....	487
4.2 Zamenjava ploščatega tečaja .....	490
4.2.1 Odstranjevanje ploščatega tečaja .....	490
4.2.2 Namestitev ploščatega tečaja .....	492
4.3 Zamenjava drsnega tečaja .....	493
4.3.1 Odstranjevanje drsnega tečaja .....	493
4.3.2 Namestitev drsnega tečaja .....	494
4.4 Zamenjava vratnega predala .....	495
4.4.1 Odstranjevanje vratnega predala .....	495
4.4.2 Namestitev vratnega predala .....	495
4.5 Zamenjava police .....	496
4.5.1 Odstranjevanje police .....	496
4.5.2 Namestitev police .....	496
4.6 Zamenjava razširljive police .....	497
4.6.1 Odstranjevanje razširljive police .....	497
4.6.2 Namestitev razširljive police .....	497
4.7 Zamenjava police zamrzovalnega dela .....	498
4.7.1 Odstranjevanje police zamrzovalnega dela .....	498
4.7.2 Namestitev police zamrzovalnega dela .....	498
4.8 Zamenjava predala za zamrznjena živila .....	499
4.8.1 Odstranjevanje predala za zamrznjena živila .....	499
4.8.2 Namestitev predala za zamrznjena živila .....	499
4.9 Zamenjava predala za sadje in zelenjavo .....	500
4.9.1 Odstranjevanje predala za sadje in zelenjavo .....	500
4.9.2 Namestitev predala za sadje in zelenjavo .....	500
4.10 Zamenjava pregrade in police nad predalom za sadje in zelenjavo .....	501
4.10.1 Odstranjevanje pregrade in police nad predalom za sadje in zelenjavo .....	501
4.10.2 Namestitev pregrade in police nad predalom za sadje in zelenjavo .....	501
4.11 Zamenjava predala za podaljšanje svežine .....	502
4.11.1 Odstranjevanje predala za podaljšanje svežine .....	502
4.11.2 Namestitev predala za podaljšanje svežine .....	502
4.12 Zamenjava razširljivega predala .....	503
4.12.1 Odstranjevanje razširljivega predala .....	503
4.12.2 Namestitev razširljivega predala .....	503
4.13 Zamenjava točkovne lučke LED .....	504
4.13.1 Odstranjevanje točkovne lučke LED .....	504
4.13.2 Namestitev točkovne lučke LED .....	505

# **i** V zvezi s tem dokumentom

## 1.1 Pomembne informacije

### 1.1.1 Namen

Ti namigi za popravila uporabnika podpirajo pri lastnoročnem popravilu aparatov skladno z veljavno direktivo glede okoljsko primerne zasnove (od marca 2021).

Vsebujejo informacije o tem, kako zamenjati določene rezervne dele, vključno z opozorili in tveganji.

Če imate kakšna vprašanja, se obrnite na našo servisno službo. Za škodo bomo odgovorni le, če ste namige za popravila upoštevali pravilno.

## 1.2 Razlaga simbolov

### 1.2.1 Stopnje nevarnosti

Stopnje opozoril so sestavljene iz simbola in signalne besede. Signalna beseda označuje stopnjo nevarnosti.





Stopnja opozorila	Pomen
 <b>NEVARNOST</b>	Neupoštevanje opozorilnega sporočila bo povzročilo smrt ali hude poškodbe.
 <b>OPOZORILO</b>	Neupoštevanje opozorilnega sporočila lahko povzroči smrt ali hude poškodbe.
 <b>PREVIDNO</b>	Neupoštevanje opozorilnega sporočila lahko povzroči manjše poškodbe.
 <b>POZOR!</b>	Neupoštevanje opozorilnega sporočila lahko povzroči škodo na lastnini.

Preglednica 1: Stopnje nevarnosti



### 1.2.2 Simboli za nevarnost

Simboli za nevarnost so simbolni prikazi, ki podajajo informacije o vrsti nevarnosti.

V tem dokumentu so uporabljeni naslednji simboli za nevarnost:

Simbol za nevarnost	Pomen
	Splošno opozorilno sporočilo
	Nevarnost zaradi električne napetosti
	Nevarnost eksplozije
	Nevarnost ureznin
	Nevarnost zmečkanin

## **i** V zvezi s tem dokumentom

Simbol za nevarnost	Pomen
	Nevarnost zaradi vročih površin
	Nevarnost zaradi močnega magnetnega polja
	Nevarnost zaradi neionizirajočega sevanja

Preglednica 2: Simboli za nevarnost

### 1.2.3 Struktura opozoril

Opozorila v tem dokumentu imajo standardiziran videz in standardizirano strukturo.



	<div style="background-color: red; color: white; padding: 2px; text-align: center;"><b>⚠ NEVARNOST</b></div> <p><b>Vrsta in vir nevarnosti!</b> Morebitne posledice ob neupoštevanju nevarnosti/opozorila.</p> <ul style="list-style-type: none"> <li>▶ Ukrepi in prepovedi za preprečevanje nevarnosti.</li> </ul>
--	---





V naslednjem primeru je prikazano opozorilo, ki opozarja pred električnim udarom zaradi delov pod napetostjo. Naveden je ukrep za preprečevanje nevarnosti.

	<div style="background-color: red; color: white; padding: 2px; text-align: center;"><b>⚠ NEVARNOST</b></div> <p><b>Nevarnost električnega udara zaradi delov pod napetostjo!</b> Smrt zaradi električnega udara</p> <ul style="list-style-type: none"> <li>▶ Izključite aparate iz električnega omrežja vsaj 60 sekund pred začetkom popravil.</li> </ul>
---	---

### 1.2.4 Splošni simboli

V tem dokumentu so uporabljeni naslednji splošni simboli:

Splošni simbol	Pomen
	Identifikacija posebnega nasveta (besedilo in/ali slika)
	Identifikacija preprostega nasveta (samo besedilo)
	Identifikacija povezave na video vadnico

Splošni simbol	Pomen
	Identifikacija potrebnih orodij
	Identifikacija potrebnih predpogojev
	Identifikacija pogoja (če ..., potem ...)
	Identifikacija rezultata
Začetek	Identifikacija tipke ali gumba
[00123456]	Identifikacija številke dela
Stanje	Identifikacija prikazanega besedila/okna (na zaslonu aparata)

Preglednica 3: Splošni simboli

## 2.1 Splošna varnostna navodila

### 2.1.1 Vsi gospodinjski aparati

#### **Nevarnost električnega udara zaradi delov pod napetostjo!**

- Napake zaradi popravil električnih komponent lahko povzročijo električni udar!
- Aparat izključite iz električnega omrežja vsaj 60 sekund pred začetkom del.
- Po popravilu je treba izvesti preizkus varnosti v skladu z VDE 0701 ali predpisi, ki veljajo za posamezno državo.

#### **Nevarnost poškodb zaradi ostrih robov!**

- Uporabljajte zaščitne rokavice.

#### **Nevarnost zmečkanin med popravili, vzdrževanjem, odpravljanjem težav ali servisom zaradi težkih in premikajočih se komponent**

- Uporabljajte zaščitne čevlje.
- Težke komponente zavarujte pred padanjem.
- Delov telesa ne vstavljajte v premikajoče se komponente.



#### **Tveganje za varnost/delovanje aparata!**

- Uporabljajte le originalne nadomestne dele.

#### **Tveganje poškodb elektrostatično občutljivih komponent (ESD)!**

- Ne dotikajte se modulov, vključno s povezavami in potmi vodnika.

## Orodja in pripomočki

Oznaka	Podrobnosti	Slike
Zaščitna krpa [00342013]	60 cm x 50 cm	
Nastavek Torx TX20 [00340865]	6,3 mm (1/4")	
Posebno orodje [00342180]		

## 4.1 Zamenjava tesnila vrat

### Zahteva:

-  Vrata so odprta.

### 4.1.1 Odstranjevanje tesnila vrat

1. V levem in desnem kotu sprostite tesnilo vrat iz utora.

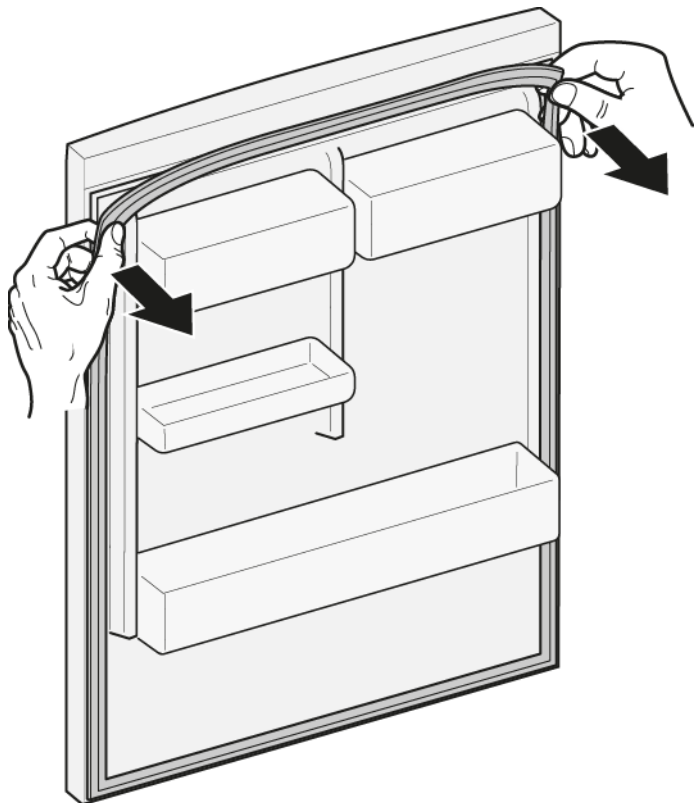

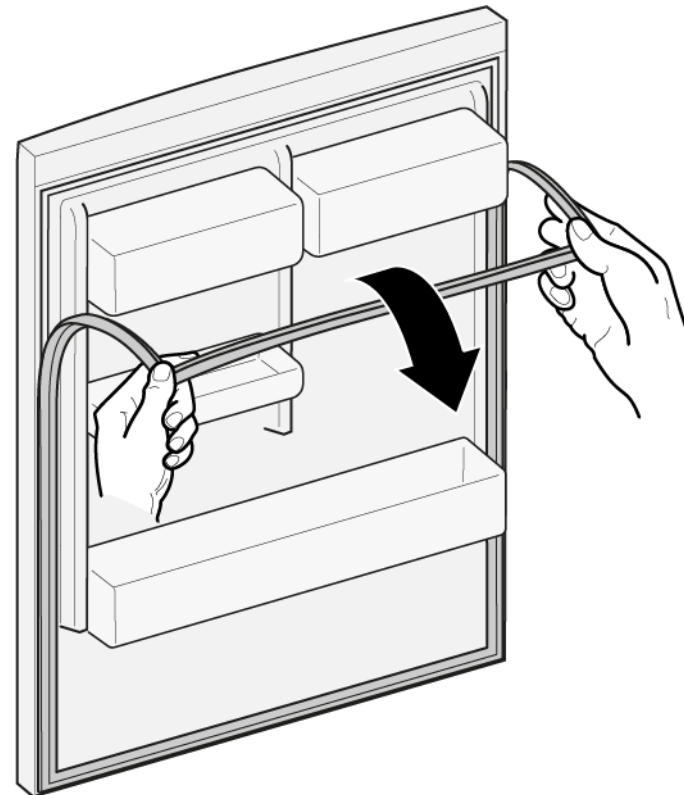

2. Tesnilo vrat izvlecite iz utora.



-  Tesnilo vrat je odstranjeno.

### 4.1.2 Namestitev tesnila vrat

	Debelina novega tesnila vrat se lahko nekoliko razlikuje od starega tesnila vrat. To ne vpliva na zapiranje in dolgoročno delovanje aparata.
	Če ima aparat nastavljive tečaje ali priključke tečajev, lahko zapiranje naknadno tudi prilagodite.
	Majhne stranske luknje v tesnilu vrat imajo svoj namen (potrebne so za prezračevanje). Ne gre za proizvodne napake.

## Popravilo

1. Preverite, ali je utor za tesnilo poškodovan.

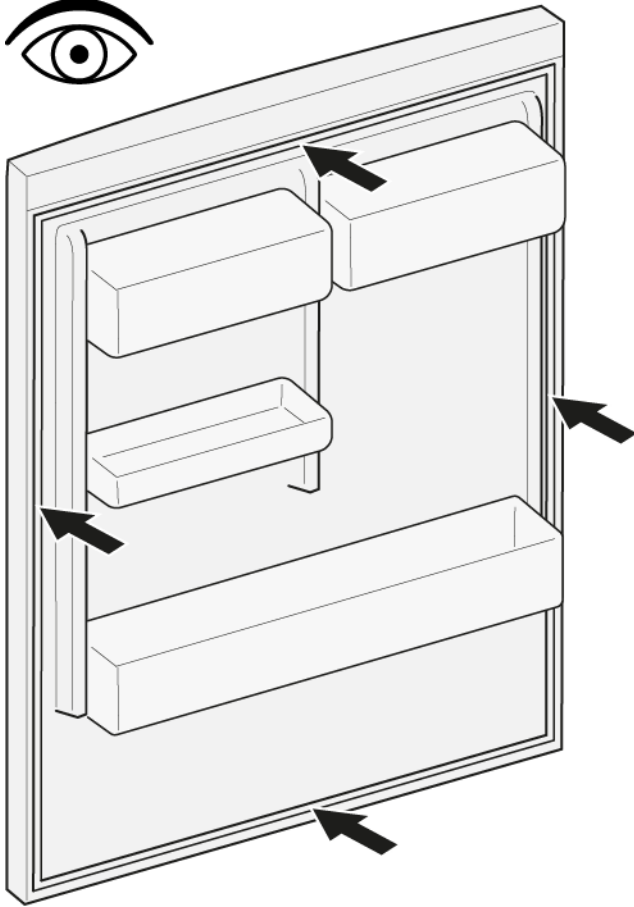

4. Vogale tesnila zgoraj in spodaj potisnite v utor.

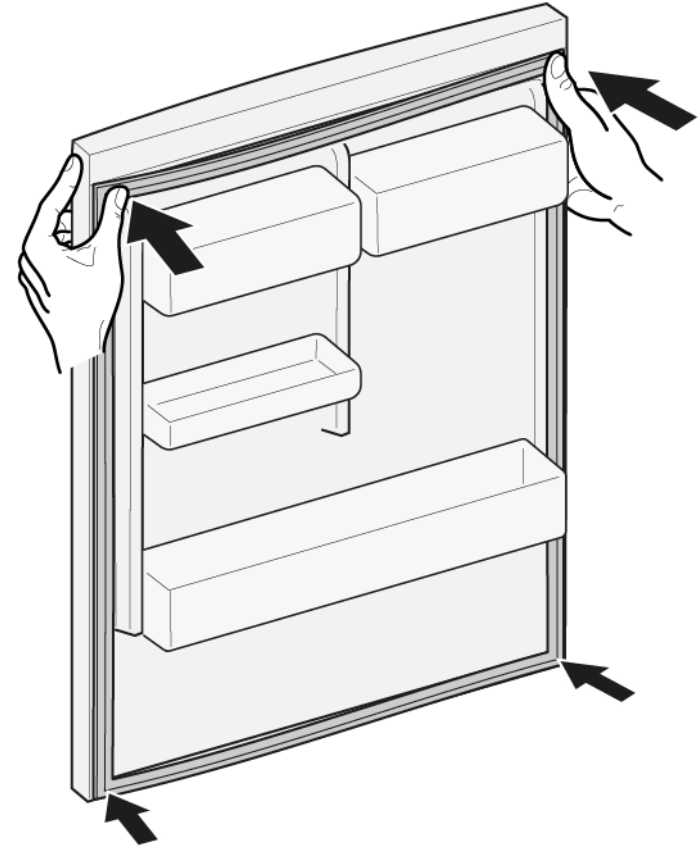

2.  Če je utor za tesnilo poškodovan:
  - se obrnite na našo servisno službo.

3.  Majhna deformacija tesnila vrat je običajna in ne vpliva na njegovo delovanje. Priporočljivo je, da tesnilo vrat pred namestitvijo v aparat poravnate.

Tesnilo vrat lahko segrejete s sušilnikom za lase ali toplo vodo, da ga ročno preoblikujete.



## Popravilo

5. Celotno tesnilo korak po koraku potisnite v utór.

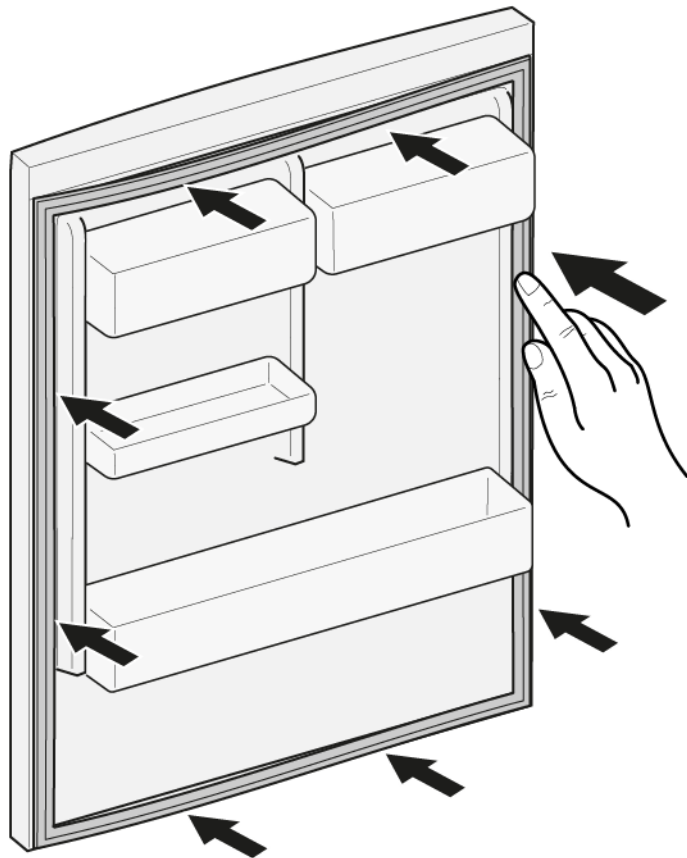

 Tesnilo vrat je nameščeno.

## 4.2 Zamenjava ploščatega tečaja

### Posebna orodja:

🌀 Nastavek Torx TX20      6,3 mm (1/4")      [00340865]

	<b>⚠️ OPOZORILO</b>
	<p><b>Težki, veliki aparati!</b> Poškodbe hrbta in mišic</p> <ul style="list-style-type: none"> <li>▶ Postopek odstranjevanja vrat aparata naj izvaja samo pooblašče-no strokovno osebje.</li> <li>▶ Za premikanje aparata sta potrebni dve osebi.</li> <li>▶ Uporabite samo ustrezno orodje in opremo.</li> </ul>

	<b>⚠️ PREVIDNO</b>
	<p><b>Ostri robovi!</b> Ureznine</p> <ul style="list-style-type: none"> <li>▶ Uporabljajte zaščitne rokavice.</li> </ul>

	<b>⚠️ PREVIDNO</b>
	<p><b>Odprite območje tečaja!</b> Zmečkanine/zagozditev prstov</p> <ul style="list-style-type: none"> <li>▶ Ne segajte v območje tečajev.</li> <li>▶ Uporabljajte zaščitne rokavice.</li> </ul>

	<b>⚠️ PREVIDNO</b>
	<p><b>Nevarnost padajočih delov zaradi zrahljanih vijakov!</b> Poškodbe zaradi padajočih delov.</p> <ul style="list-style-type: none"> <li>▶ Komponento zaščitite pred padcem.</li> </ul>

	<b>POZOR!</b>
	<p><b>Nevarnost padajočih delov zaradi zrahljanih vijakov!</b> Škoda na drugih delih aparata ali pri uporabniku doma, npr. na tleh.</p> <ul style="list-style-type: none"> <li>▶ Komponento zaščitite pred padcem.</li> </ul>

### Zahteva:

- ✔ Aparat je odklopljen iz omrežne napetosti.
- ✔ Pohištvna vrata so odstranjena. Glejte navodila za namestittev.
- ✔ Vrata so odprta.

## 4.2.1 Odstranjevanje ploščatega tečaja

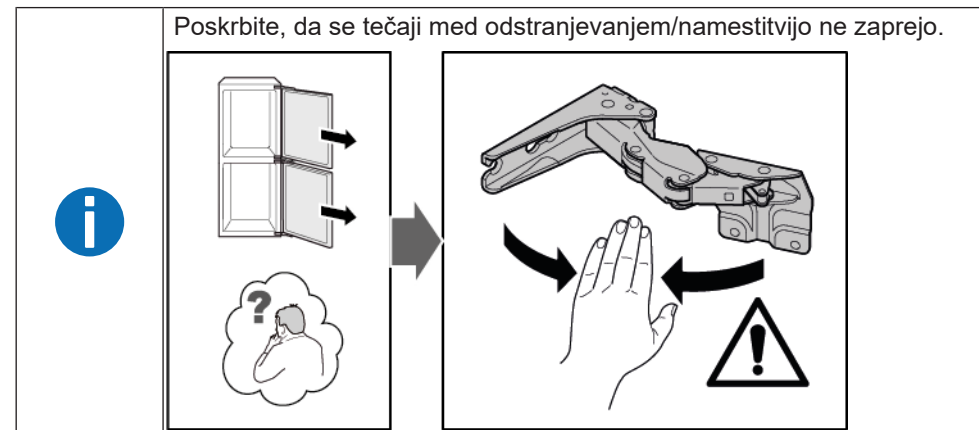

1. Odstranite štiri pokrovčke tečaja.

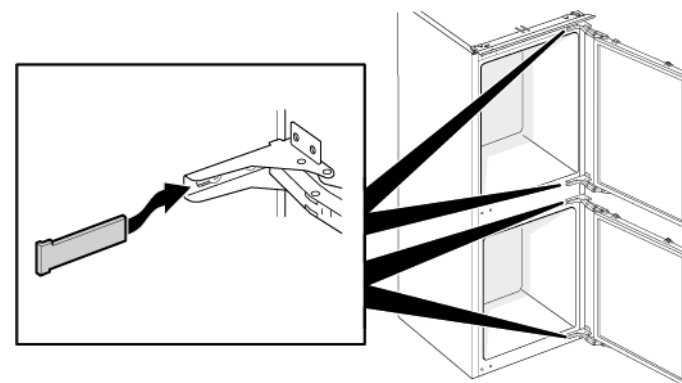

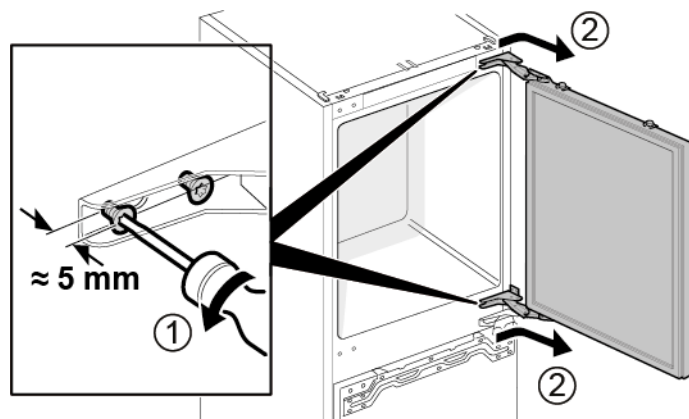

## Popravilo

2. 1. Odvijte štiri vijake (1).  
2. Zgornja vrata izvlecite in jih odstranite (2).

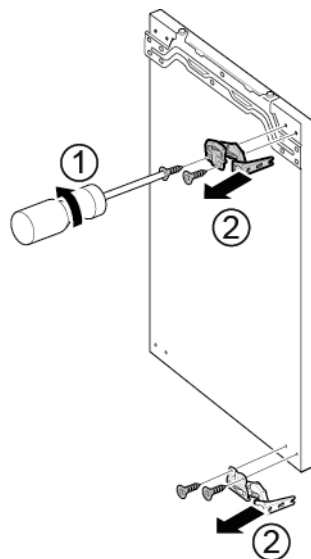

3. 1. Odstranite štiri vijake (1).  
2. Odstranite tečaja (2).



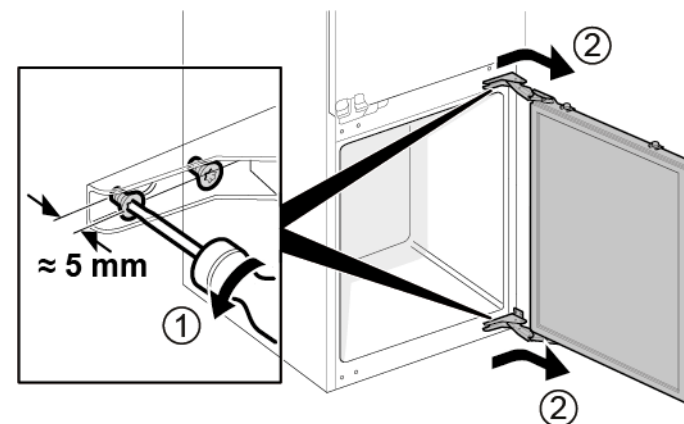

 Tečaja zgornjih vrat sta odstranjena.

4. 1. Odvijte štiri vijake (1).  
2. Spodnja vrata izvlecite in jih odstranite (2).

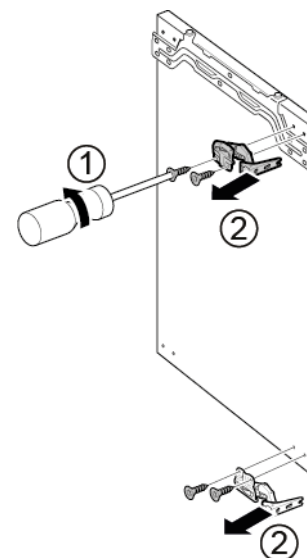

5. 1. Odstranite štiri vijake (1).  
2. Odstranite tečaja (2).



 Tečaja spodnjih vrat sta odstranjena.

### 4.2.2 Namestitev ploščatega tečaja

- ▶ Namestite v obratnem vrstnem redu.

## 4.3 Zamenjava drsnega tečaja

### Posebna orodja:

🌀 Nastavek Torx TX20      6,3 mm (1/4")      [00340865]

	<b>⚠️ OPOZORILO</b>
<b>Težki, veliki aparati!</b>	
Poškodbe hrbta in mišic	
<ul style="list-style-type: none"> <li>▶ Postopek odstranjevanja vrat aparata naj izvaja samo pooblašče-no strokovno osebje.</li> <li>▶ Za premikanje aparata sta potrebni dve osebi.</li> <li>▶ Uporabite samo ustrezno orodje in opremo.</li> </ul>	

	<b>⚠️ PREVIDNO</b>
<b>Ostri robovi!</b>	
Ureznine	
<ul style="list-style-type: none"> <li>▶ Uporabljajte zaščitne rokavice.</li> </ul>	

	<b>⚠️ PREVIDNO</b>
<b>Nevarnost padajočih delov zaradi zrahljanih vijakov!</b>	
Poškodbe zaradi padajočih delov.	
<ul style="list-style-type: none"> <li>▶ Komponento zaščitite pred padcem.</li> </ul>	

	<b>POZOR!</b>
<b>Nevarnost padajočih delov zaradi zrahljanih vijakov!</b>	
Škoda na drugih delih aparata ali pri uporabniku doma, npr. na tleh.	
<ul style="list-style-type: none"> <li>▶ Komponento zaščitite pred padcem.</li> </ul>	

### Zahteva:

- ✅ Aparat je odklopljen iz omrežne napetosti.
- ✅ Pehlivna vrata so ločena od vrat aparata. Glejte navodila za namestitev.

## 4.3.1 Odstranjevanje drsnega tečaja

1. 1. Odvijte vijaka (1).
2. 2. Odstranite zgornji tečaj zgornjih vrat (2).
3. 3. Odstranite zgornja vrata (3).
4. 4. Odvijte vijaka (4).
5. 5. Odstranite zgornji tečaj spodnjih vrat (5).
6. 6. Odstranite spodnja vrata (6).

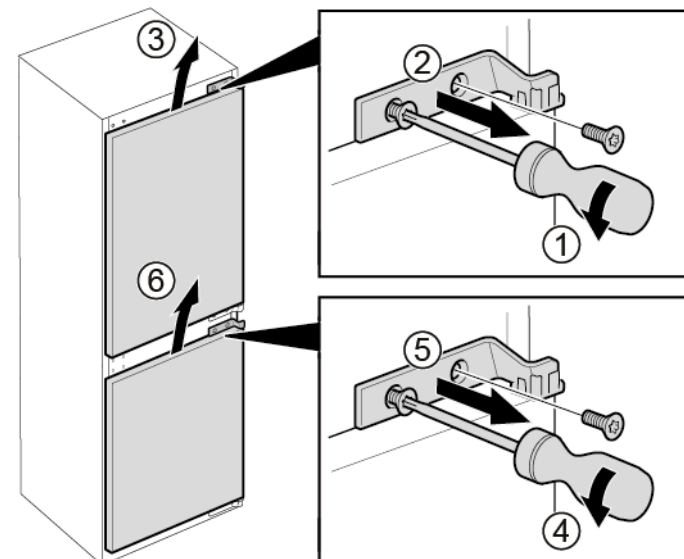

## Popravilo

2. 1. Odstranite štiri vijake (1).
2. Odstranite spodnja tečaja (2).

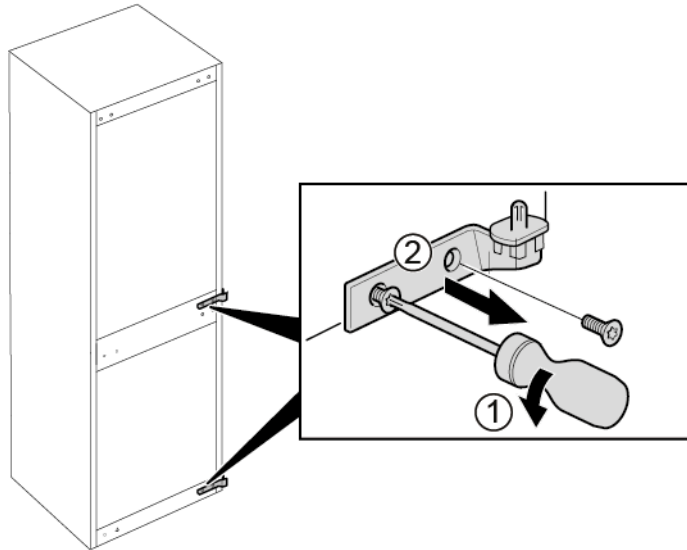

 Tečaja sta odstranjena.

### 4.3.2 Namestitev drsnega tečaja

- ▶ Namestite v obratnem vrstnem redu.

## 4.4 Zamenjava vratnega predala

### Zahteva:

- ✔ Vrata so odprta.

### 4.4.1 Odstranjevanje vratnega predala

- ▶ Dvignite vrtni predal navzgor.

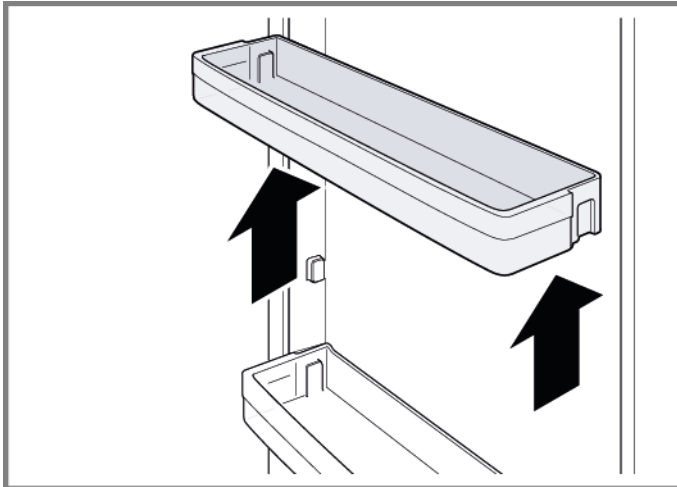

- ➡ Vratni predal je odstranjen.

### 4.4.2 Namestitev vratnega predala

- ▶ Namestite v obratnem vrstnem redu.

## 4.5 Zamenjava police

### Zahteva:

- ✔ Vrata so odprta.

### 4.5.1 Odstranjevanje police

- ▶ Izvlecite polico.

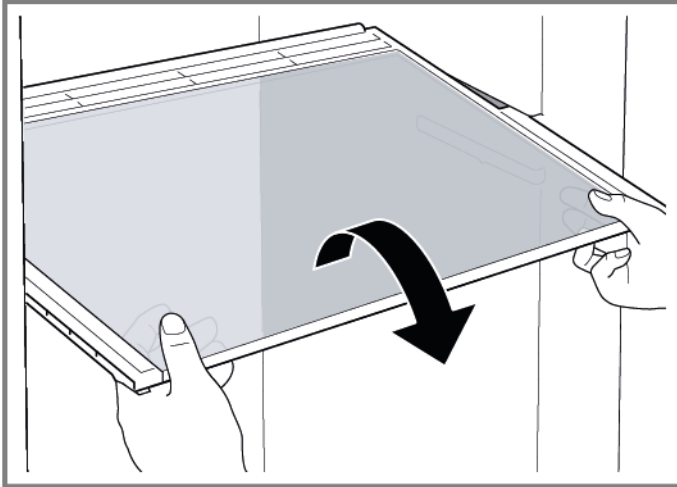

- ➡ Polica je odstranjena.

### 4.5.2 Namestitev police

- ▶ Namestite v obratnem vrstnem redu.



## 4.6 Zamenjava razširljive police

### Zahteva:

- ✔ Vrata so odprta.

### 4.6.1 Odstranjevanje razširljive police

1. Razširljivo polico potegnite k sebi, dokler se zaklepni zapah ne sprostí.

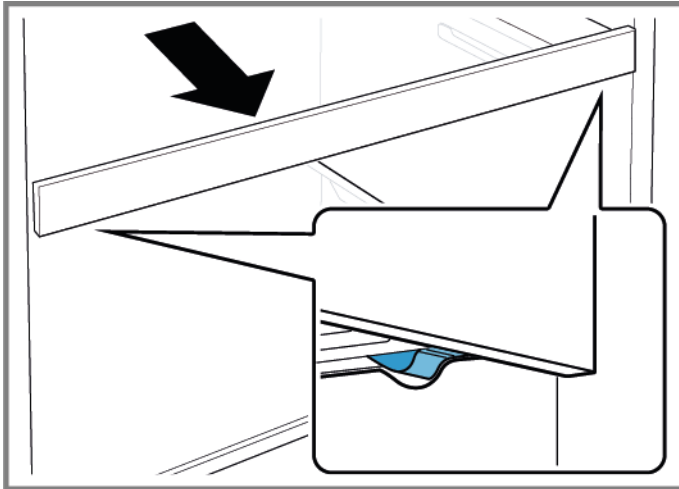

2. Razširljivo polico poveznite navzdol in jo z obračanjem na stran odstranite.
3. ➡ Razširljiva polica je odstranjena.

### 4.6.2 Namestitev razširljive police

- ▶ Namestite v obratnem vrstnem redu.

## 4.7 Zamenjava police zamrzovalnega dela

### Zahteva:

- ✔ Vrata so odprta.

### 4.7.1 Odstranjevanje police zamrzovalnega dela

- ▶ Izvlecite polico zamrzovalnega dela.

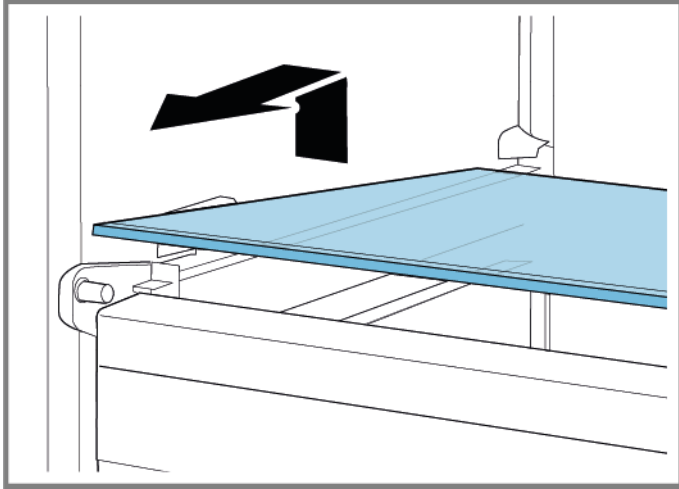

- ➡ Polica zamrzovalnega dela je odstranjena.

### 4.7.2 Namestitev police zamrzovalnega dela

- ▶ Namestite v obratnem vrstnem redu.

## 4.8 Zamenjava predala za zamrznjena živila

### Zahteva:

- ✔ Vrata so odprta.

### 4.8.1 Odstranjevanje predala za zamrznjena živila

- ▶ 1. Predal za zamrznjena živila izvlecite do konca (1).
- ▶ 2. Odstranite predal za zamrznjena živila (2).

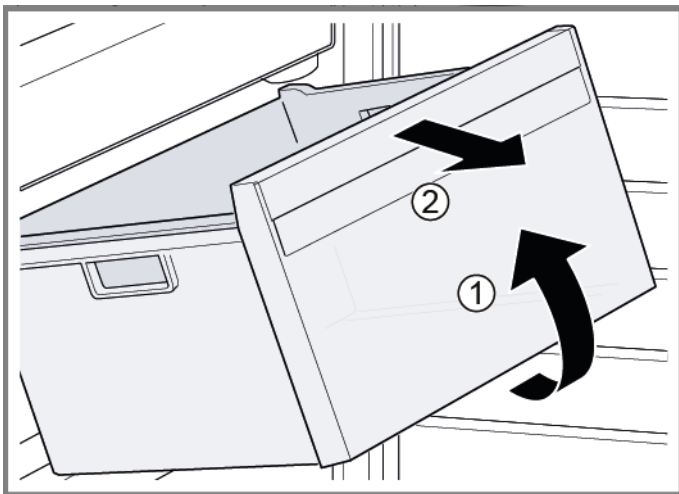

- ➡ Predal za zamrznjena živila je odstranjen.

### 4.8.2 Namestitev predala za zamrznjena živila

- ▶ Namestite v obratnem vrstnem redu.

## 4.9 Zamenjava predala za sadje in zelenjavo

### Zahteva:

- ✔ Vrata so odprta.

### 4.9.1 Odstranjevanje predala za sadje in zelenjavo

- ▶ 1. Predal izvlecite do konca (1).
- ▶ 2. Predal odstranite (2).

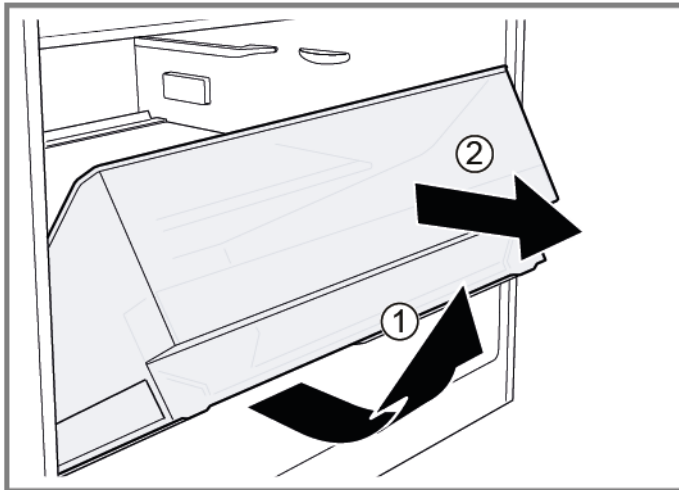

- ➡ Predal je odstranjen.

### 4.9.2 Namestitev predala za sadje in zelenjavo

- ▶ Namestite v obratnem vrstnem redu.

## 4.10 Zamenjava pregrade in police nad predalom za sadje in zelenjavo

### Zahteva:

- ✔ Vrata so odprta.

### 4.10.1 Odstranjevanje pregrade in police nad predalom za sadje in zelenjavo

1. S pregrade odstranite stekleno ploščo.

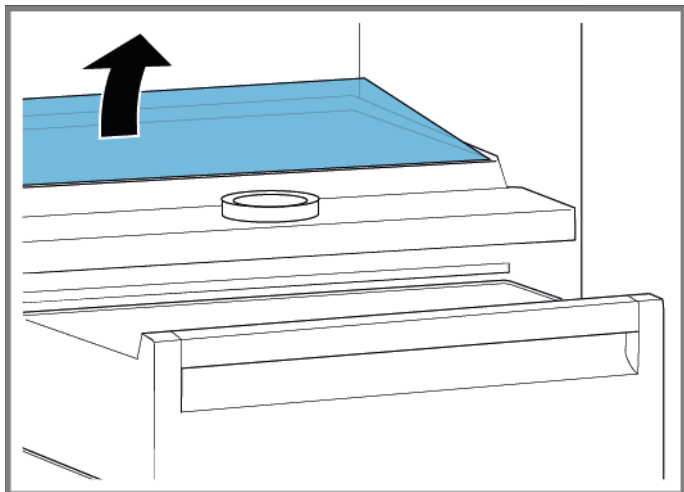

2. [Odstranite predal za sadje in zelenjavo. → 500](#)

3. 1. Pritisnite pritrdila na spodnji strani steklene plošče (1).
2. Pregrado potegnite k sebi (2).

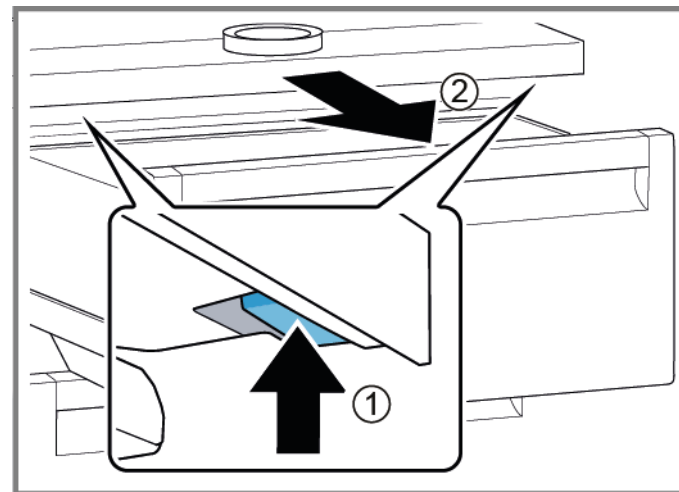

4. Pregrado dvignite in jo z obračanjem na stran odstranite.
  - ➡ Pregrada je odstranjena.
5. 1. Dvignite polico nad predalom za sadje in zelenjavo.
2. Polico nad predalom za sadje in zelenjavo potegnite k sebi in jo z obračanjem na stran odstranite.
  - ➡ Polica nad predalom za sadje in zelenjavo je odstranjena.

### 4.10.2 Namestitev pregrade in police nad predalom za sadje in zelenjavo

- ▶ Namestite v obratnem vrstnem redu.

## 4.11 Zamenjava predala za podaljšanje svežine

### Zahteva:

- ✔ Vrata so odprta.

### 4.11.1 Odstranjevanje predala za podaljšanje svežine

- ▶ 1. Predal za podaljšanje svežine nagnite k sebi (1).
- ▶ 2. Odstranite predal za podaljšanje svežine (2).

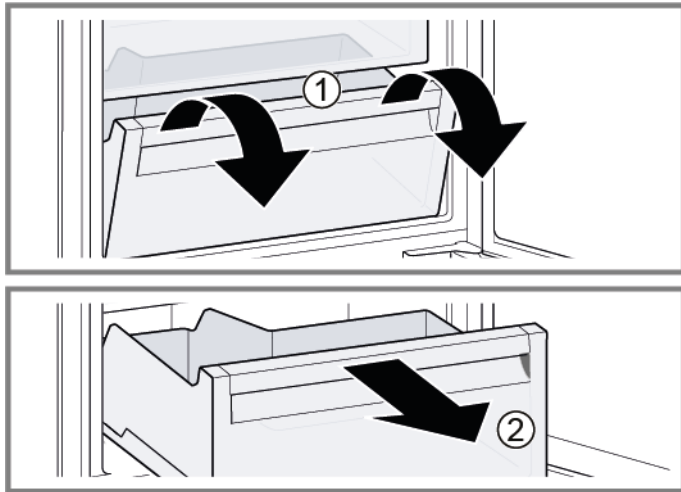

➡ Predal za podaljšanje svežine je odstranjen.

### 4.11.2 Namestitev predala za podaljšanje svežine

- ▶ Namestite v obratnem vrstnem redu.

## 4.12 Zamenjava razširljivega predala

### Zahteva:

- ✔ Vrata so odprta.

### 4.12.1 Odstranjanje razširljivega predala

- ▶ 1. Razširljivi predal nagnite k sebi (1).
- ▶ 2. Odstranite razširljivi predal (2).

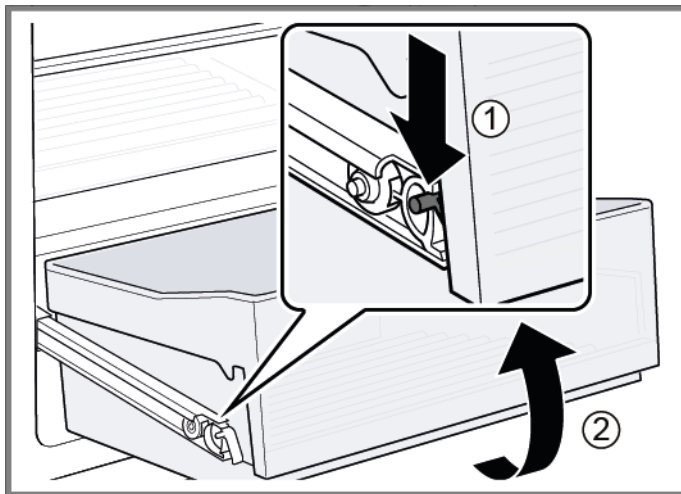

➡ Razširljivi predal je odstranjen.

### 4.12.2 Namestitev razširljivega predala

- ▶ Namestite v obratnem vrstnem redu.

## 4.13 Zamenjava točkovne lučke LED

### Posebna orodja:

- 🔧 Posebno orodje [00342180]
- 🔧 Ploščati izvijač      Steblo 2,4 mm x 0,4 mm x 60 mm, v kompletu [00341820]

**i** Vaš aparat je opremljen z osvetlitvijo LED, ki ne potrebuje vzdrževanja. To vrsto osvetlitve lahko popravi samo servisna služba ali pooblaščen strokovno osebje!

**⚠️ NEVARNOST**  
**Nevarnost električnega udara zaradi delov pod napetostjo!**  
 Življenjska nevarnost zaradi električnega udara v primeru nepravilnega popravila

- ▶ Električne dele mora popraviti kvalificiran električar.
- ▶ Po popravilu je treba izvesti preizkus varnosti v skladu z VDE 0701 ali predpisi, ki veljajo za posamezno državo.

**⚠️ NEVARNOST**  
**Nevarnost električnega udara zaradi delov pod napetostjo!**  
 Smrt zaradi električnega udara

- ▶ Izključite aparate iz električnega omrežja vsaj 60 sekund pred začetkom popravil.

**⚠️ PREVIDNO**  
**Ostri robovi!**  
 Ureznine

- ▶ Uporabljajte zaščitne rokavice.

### Zahteva:

- ✅ Aparat je odklopljen iz omrežne napetosti.
- ✅ Vrata so odprta.
- ✅ Police hladilnega dela so odstranjene.

## 4.13.1 Odstranjevanje točkovne lučke LED

1. Sprostite pokrovček točkovne lučke LED.

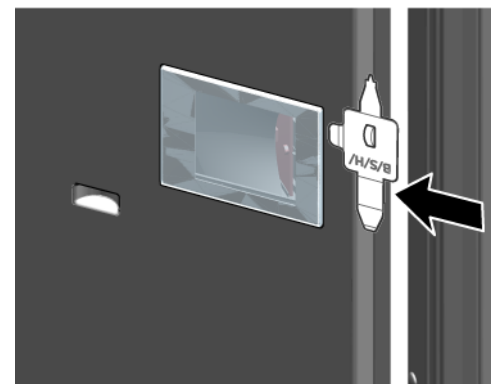

2. Pokrovček točkovne lučke LED povlecite navznoter in ga hkrati potisnite naprej.

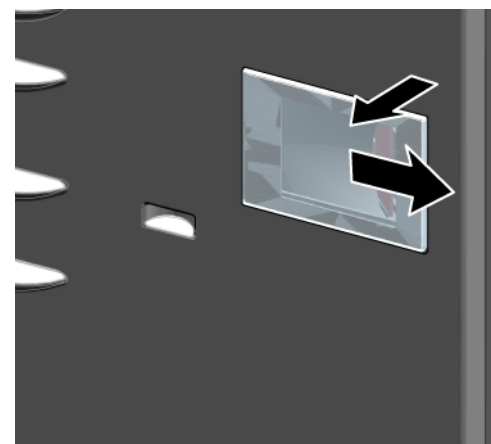



3. Odklopite modul točkovne lučke LED.

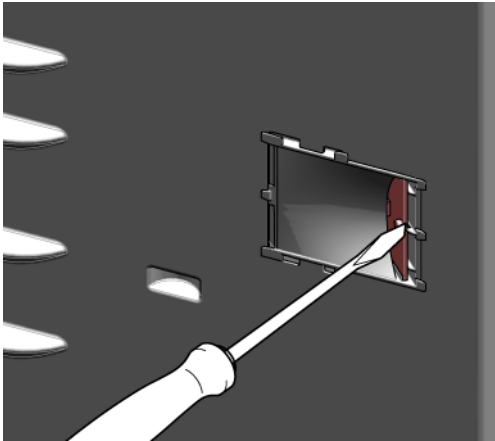

4. Odklopite električno povezavo točkovne lučke LED.

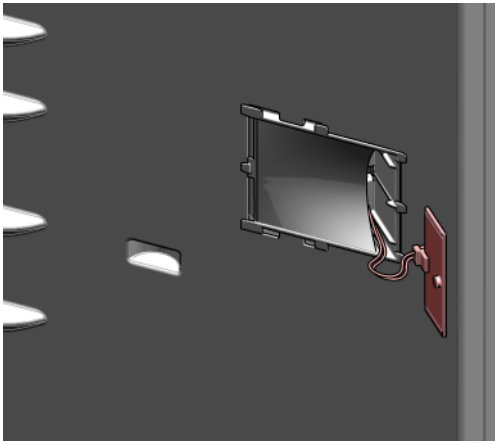





- ➡ Točkovna lučka LED je odstranjena.

### 4.13.2 Namestitev točkovne lučke LED

- ▶ Namestite v obratnem vrstnem redu.

# Consejos de reparación - Frigorífico / congelador

 <b>En relación con este documento</b> .....	<b>507</b>
1.1 Información importante .....	507
1.1.1 Finalidad .....	507
1.2 Explicación de símbolos generales .....	507
1.2.1 Niveles de peligrosidad .....	507
1.2.2 Símbolos de peligro .....	507
1.2.3 Estructura de las advertencias .....	508
1.2.4 Símbolos generales .....	508
 <b>Seguridad</b> .....	<b>509</b>
2.1 Instrucciones generales de seguridad .....	509
2.1.1 Todos los aparatos electrodomésticos.....	509
 <b>Herramientas y auxiliares</b> .....	<b>510</b>
 <b>Reparación</b> .....	<b>511</b>
4.1 Sustituir la junta de la puerta .....	511
4.1.1 Retirar la junta de la puerta.....	511
4.1.2 Montar la junta de la puerta .....	511
4.2 Sustituir la bisagra plana .....	514
4.2.1 Desmontar la bisagra plana .....	514
4.2.2 Montar la bisagra plana .....	516
4.3 Sustituir la bisagra deslizante .....	517
4.3.1 Desmontar la bisagra deslizante .....	517
4.3.2 Montar la bisagra deslizante .....	518
4.4 Sustituir el estante de la puerta .....	519
4.4.1 Extraer el estante de la puerta .....	519
4.4.2 Montar el estante de la puerta.....	519
4.5 Sustituir el estante .....	520
4.5.1 Extraer el estante .....	520
4.5.2 Montar el estante .....	520
4.6 Sustituir el estante extraíble .....	521
4.6.1 Retirar el cajón extraíble.....	521
4.6.2 Montar el estante extraíble .....	521
4.7 Sustituir el estante del congelador .....	522
4.7.1 Extraer el estante del congelador.....	522
4.7.2 Montar el estante del congelador .....	522
4.8 Sustituir el cajón de productos congelados .....	523
4.8.1 Extraer el cajón de productos congelados.....	523
4.8.2 Montar el cajón de productos congelados .....	523
4.9 Sustituir el cajón para fruta y verdura .....	524
4.9.1 Extraer el cajón para fruta y verdura .....	524
4.9.2 Montar el cajón para fruta y verdura .....	524
4.10 Sustituir la división y la tapa del cajón para fruta y verdura .....	525
4.10.1 Retirar la división y la tapa del cajón para fruta y verdura.....	525
4.10.2 Montar la división y la tapa del cajón para fruta y verdura .....	525
4.11 Sustituir el cajón «Cool-fresh» .....	526
4.11.1 Extraer el cajón «Cool-fresh» .....	526
4.11.2 Montar el cajón «Cool-fresh» .....	526
4.12 Sustituir el cajón extraíble.....	527
4.12.1 Retirar el cajón extraíble .....	527
4.12.2 Montar el cajón extraíble .....	527
4.13 Sustituir el foco LED .....	528
4.13.1 Desmontar el foco LED .....	528
4.13.2 Montar el foco LED .....	529

# **i** En relación con este documento

## 1.1 Información importante

### 1.1.1 Finalidad

Estas indicaciones de reparación sirven como ayuda al consumidor para reparar aparatos por su cuenta conforme al reglamento aplicable sobre diseño ecológico (a partir de 03/2021).

Contienen información sobre cómo sustituir repuestos determinados e incluye las advertencias y los riesgos.

En caso de dudas, póngase en contacto con nuestro departamento de atención al cliente. Solo asumiremos la responsabilidad por daños si las indicaciones de reparación se han seguido correctamente.

## 1.2 Explicación de símbolos generales

### 1.2.1 Niveles de peligrosidad

Los niveles de peligro consisten en un símbolo y una palabra de advertencia. La palabra de advertencia identifica la gravedad del peligro.





Nivel de peligro	Significado
 <b>PELIGRO</b>	Si no se tiene en cuenta la advertencia, ocasionará la muerte o lesiones graves.
 <b>ADVERTENCIA</b>	Si no se tiene en cuenta la advertencia, puede ocasionar la muerte o lesiones graves.
 <b>PRECAUCIÓN</b>	Si no se tiene en cuenta la advertencia, puede ocasionar lesiones de carácter leve.
<b>ATENCIÓN</b>	Si no se tiene en cuenta la advertencia, puede ocasionar daños materiales.

Tabla 1: Niveles de peligrosidad

### 1.2.2 Símbolos de peligro

Los símbolos de peligro son una representación simbólica que indica el tipo de peligrosidad.

En este documento se utilizan los siguientes símbolos de peligro:

Símbolo de peligro	Significado
	Advertencia general
	Peligro de lesiones por corriente eléctrica
	Riesgo de explosión
	Peligro de lesiones a causa de cortes

## **i** En relación con este documento





Símbolo de peligro	Significado
	Peligro de lesiones por aplastamiento
	Peligro de lesiones por superficies calientes
	Peligro a causa de campos magnéticos de gran potencia
	Peligro derivado de radiación no ionizante

Tabla 2: Símbolos de peligro

### 1.2.3 Estructura de las advertencias

Las advertencias de este documento tienen una apariencia y una estructura uniformes.

	<p><b>⚠ PELIGRO</b></p> <p><b>¡Tipo y fuente del peligro!</b> Posibles consecuencias de ignorar el peligro / la advertencia.</p> <ul style="list-style-type: none"> <li>▶ Medidas y prohibiciones para prevenir el peligro.</li> </ul>
--	--

El ejemplo siguiente muestra una advertencia de descarga eléctrica a causa de piezas o partes cargadas con tensión. Se menciona la medida para evitar el peligro.

	<p><b>⚠ PELIGRO</b></p> <p><b>¡Riesgo de descarga eléctrica debido a partes con tensión!</b> Muerte por electrocución</p> <ul style="list-style-type: none"> <li>▶ Desconectar el aparato de la red al menos 60 segundos antes de comenzar con la reparación.</li> </ul>
--	--

### 1.2.4 Símbolos generales

En este documento se utilizan los siguientes símbolos generales:

Símbolo general	Significado
	Identificación de una indicación especial (texto y/o gráfico)







Símbolo general	Significado
	Identificación de un consejo simple (solo texto)
	Identificación de un enlace a un video tutorial
	Identificación de una herramienta requerida
	Identificación de una condición previa (prerrequisito)
	Identificación de una condición (si ..., entonces ...)
	Identificación de un resultado
Iniciar	Identificación de una tecla o botón
[00123456]	Identificación de un número de material
Estado	Identificación del texto / ventana mostrado (en el display del aparato)

Tabla 3: Símbolos generales

## 2.1 Instrucciones generales de seguridad

### 2.1.1 Todos los aparatos electrodomésticos

#### ¡Riesgo de descarga eléctrica debido a piezas con tensión!

- ¡Los errores en las reparaciones que incluyan componentes eléctricos pueden provocar una descarga eléctrica!
- Desconectar el aparato de la red durante al menos 60 segundos antes de comenzar con el trabajo.
- Después de la reparación, encargar una prueba de seguridad conforme a VDE 0701 o los reglamentos específicos del país.

#### ¡Riesgo de lesiones debido a bordes afilados!

- Usar guantes de protección.

#### Riesgo de aplastamiento durante la reparación, mantenimiento, resolución de problemas y servicio debido a componentes pesados y móviles

- Usar calzado de seguridad.
- Asegure los componentes pesados para que no se caigan.
- No pegue partes del cuerpo en componentes móviles.



#### ¡Riesgo para la seguridad/el funcionamiento del aparato!

- Utilizar únicamente los repuestos originales.

#### ¡Riesgo de daños de los componentes sensibles a cargas electrostáticas (ESD)!

- No tocar los módulos, incluidas las conexiones y las pistas conductoras.

## Herramientas y auxiliares

Designacion	Detalles	Imágenes
Paño de protección [00342013]	60 cm x 50 cm	
Punta Torx TX20 [00340865]	6,3 mm (1/4")	
Herramienta especial [00342180]		

## 4.1 Sustituir la junta de la puerta

### Requisito:

- ✔ La puerta está abierta.

### 4.1.1 Retirar la junta de la puerta

1. Soltar la junta de la puerta de la ranura por las esquinas izquierda y derecha.

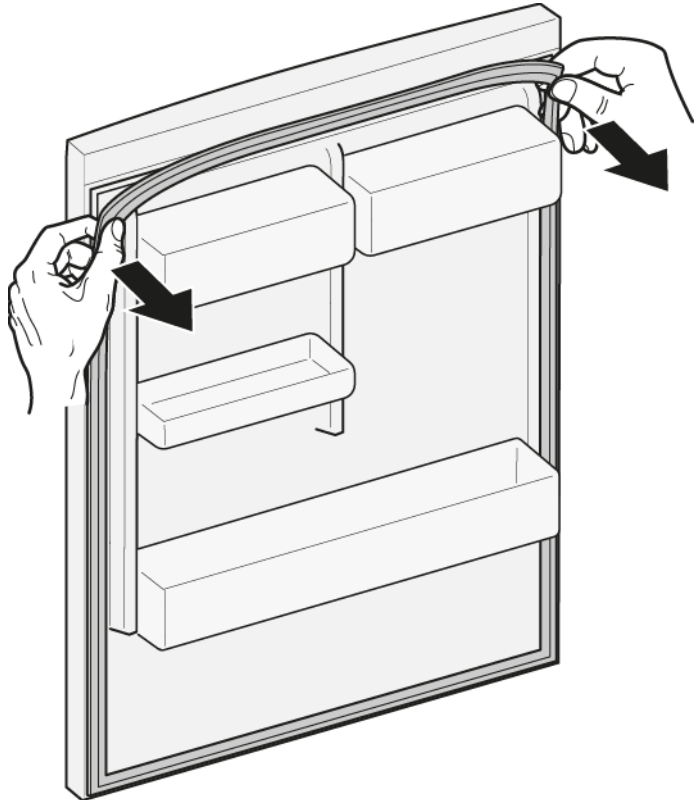

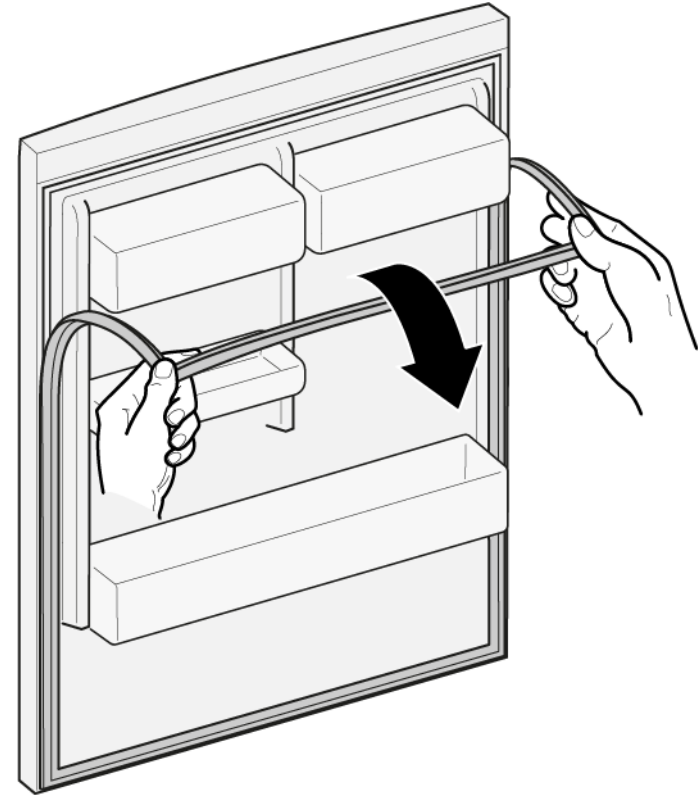

2. Sacar la junta de la puerta de la ranura.



- ➡ Se ha retirado la junta de la puerta.

### 4.1.2 Montar la junta de la puerta

	El grosor de la nueva junta de la puerta puede diferir ligeramente del grosor de la junta usada. Esto no afectará al comportamiento de cierre ni al funcionamiento a largo plazo.
	Si su aparato tienen bisagras ajustables o accesorios de bisagra, puede optimizar el comportamiento de cierre.
	Los pequeños agujeros laterales de la junta de la puerta son funcionales (necesarios para la ventilación). No se trata de un fallo de producción.

## Reparación

1. Comprobar si la ranura de la junta presenta daños.

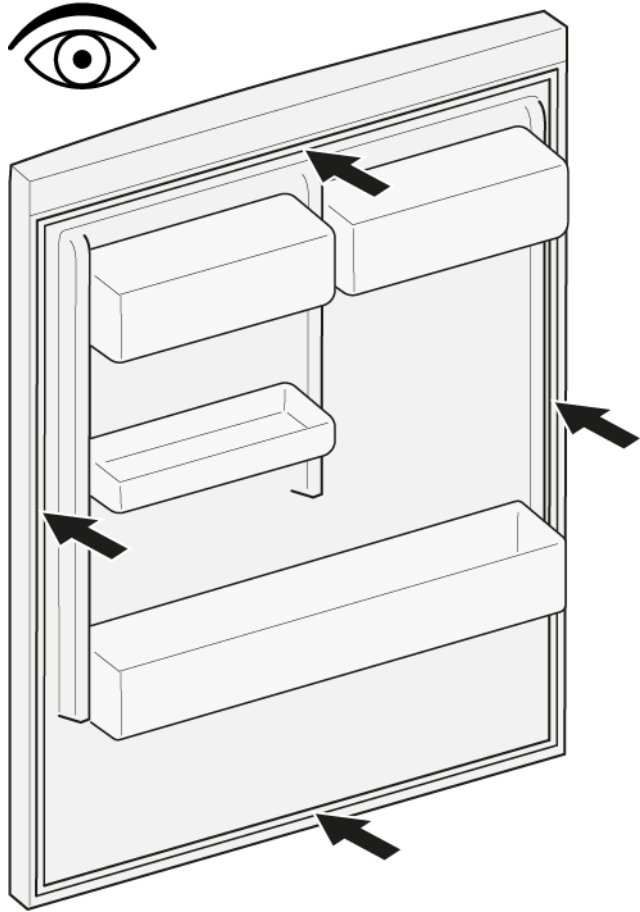

4. Presionar las esquinas de la junta en la parte superior y la inferior de la ranura.

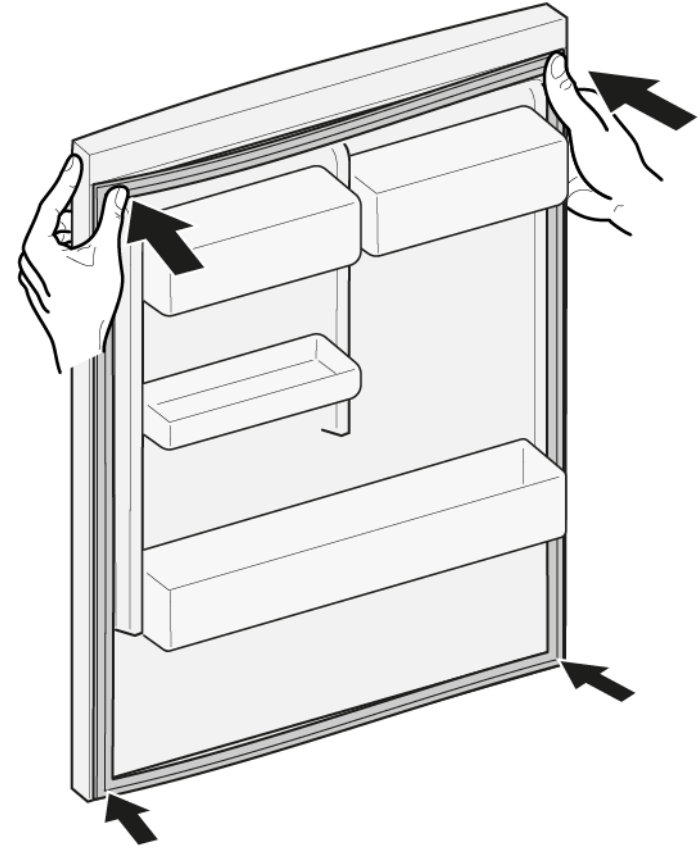

2.  Si la ranura de la junta está dañada.  
- Contactar con el servicio de atención al cliente.

3. 

	Una ligera deformación de la junta de la puerta es normal y no afecta a su función. Se recomienda alisar la junta de la puerta antes de insertarla en el aparato.
---	---

Calentar ligeramente la junta de la puerta con un secador de pelo o agua caliente y volver a darle forma con las manos.



## Reparación

5. Presionar metiendo toda la junta paso a paso en la ranura.

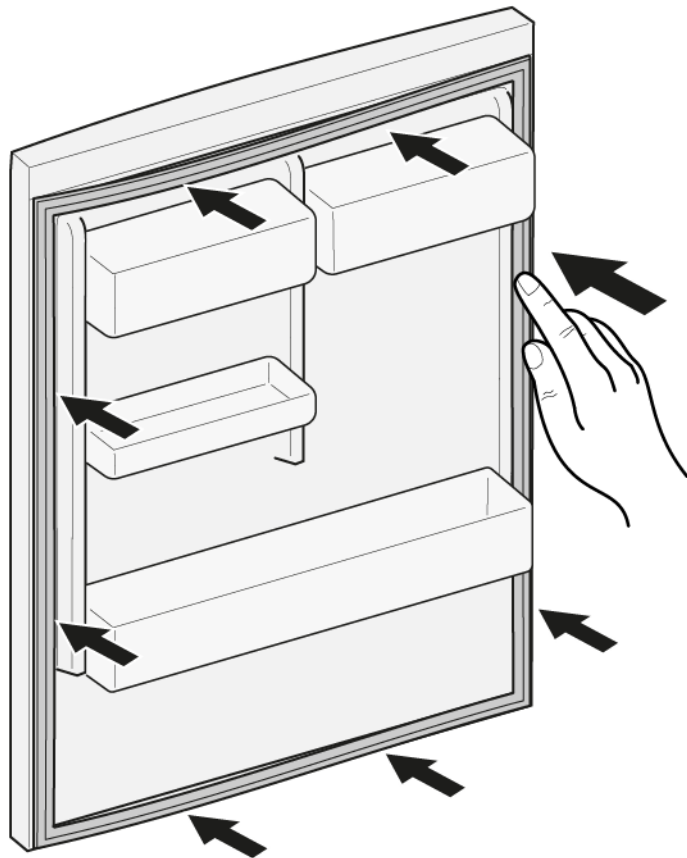



-  La junta de la puerta está montada.

## 4.2 Sustituir la bisagra plana

### Herramientas necesarias:

 Punta Torx TX20      6,3 mm (1/4")      [00340865]

	<b>⚠ ADVERTENCIA</b>
	<p><b>¡Aparatos pesados y voluminosos!</b> Espalda y lesiones musculares</p> <ul style="list-style-type: none"> <li>▶ La operación de extraer la puerta del aparato solo deben llevarla a cabo especialistas formados.</li> <li>▶ Para mover el aparato se necesitan dos personas.</li> <li>▶ Utilizar únicamente herramientas y equipos apropiados.</li> </ul>



	<b>⚠ PRECAUCIÓN</b>
	<p><b>¡Bordes o cantos cortantes!</b> Peligro de cortes</p> <ul style="list-style-type: none"> <li>▶ Usar guantes de seguridad.</li> </ul>

	<b>⚠ PRECAUCIÓN</b>
	<p><b>¡Zona de bisagra abierta!</b> Aplastamiento / atrapamiento de dedos</p> <ul style="list-style-type: none"> <li>▶ No acceder a la zona de la bisagra.</li> <li>▶ Usar guantes de seguridad.</li> </ul>



	<b>⚠ PRECAUCIÓN</b>
	<p><b>¡Riesgo de que se caigan piezas debido a los tornillos aflojados!</b> Peligro de lesiones debido a piezas que caigan.</p> <ul style="list-style-type: none"> <li>▶ Asegure el componente para que no se caiga.</li> </ul>

	<b>ATENCIÓN</b>
	<p><b>¡Riesgo de que se caigan piezas debido a los tornillos aflojados!</b> Daños en otras partes del aparato o en el domicilio del consumidor, p. ej., en la parte inferior.</p> <ul style="list-style-type: none"> <li>▶ Asegure el componente para que no se caiga.</li> </ul>

### Requisito:

-  El aparato está desconectado del suministro eléctrico.
-  Se ha retirado la puerta del mueble. Véanse las instrucciones de montaje.
-  La puerta está abierta.

### 4.2.1 Desmontar la bisagra plana

	Prestar atención a que las bisagras no se cierren durante el desmontaje/montaje.	
		

1. Retirar las cuatro tapas de las bisagras.

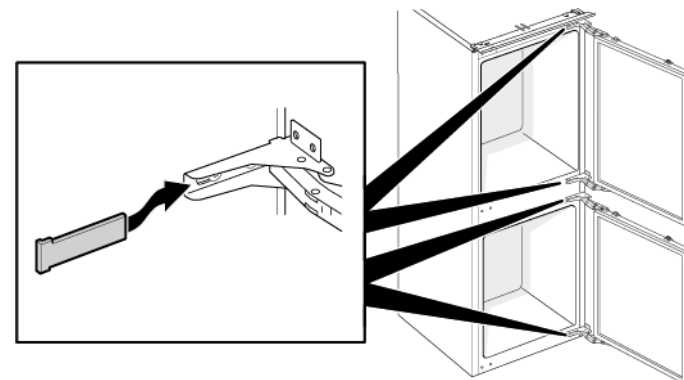

## Reparación

2. 1. Aflojar los cuatro tornillos (1).  
2. Sacar la puerta superior y retirarla (2).

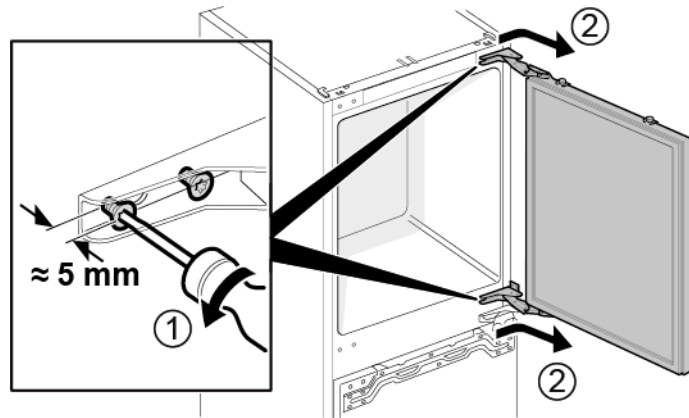

3. 1. Retirar los cuatro tornillos (1).  
2. Retirar las bisagras (2).

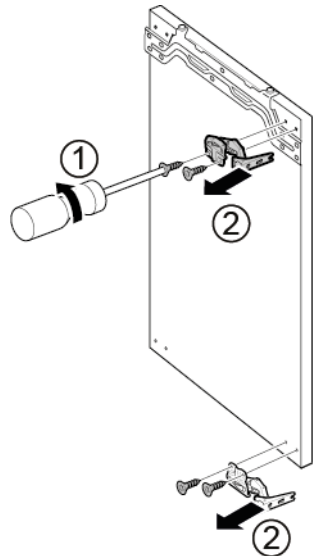

 Se han retirado las bisagras superiores de la puerta.

4. 1. Aflojar los cuatro tornillos (1).  
2. Sacar la puerta inferior y retirarla (2).

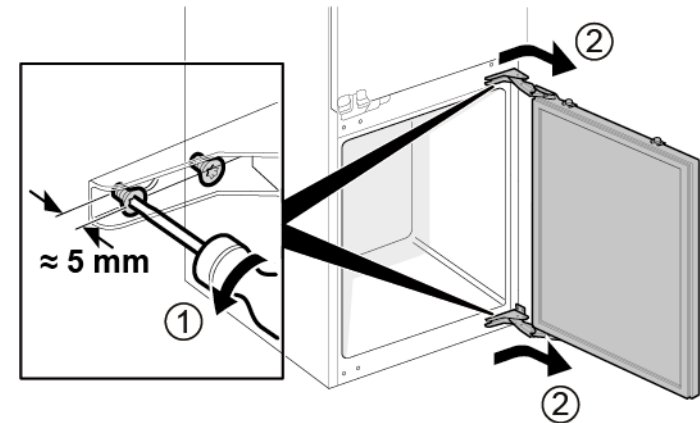

5. 1. Retirar los cuatro tornillos (1).  
2. Retirar las bisagras (2).

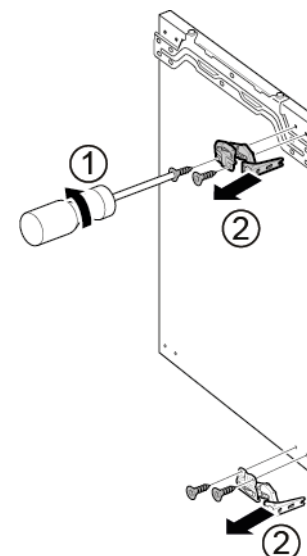

 Se han retirado las bisagras inferiores de la puerta.

## 4.2.2 Montar la bisagra plana

- ▶ Montar en orden inverso.

## 4.3 Sustituir la bisagra deslizante

### Herramientas necesarias:

🔧 Punta Torx TX20      6,3 mm (1/4")      [00340865]

	<b>⚠️ ADVERTENCIA</b>
	<b>¡Aparatos pesados y voluminosos!</b> Espalda y lesiones musculares <ul style="list-style-type: none"><li>▶ La operación de extraer la puerta del aparato solo deben llevarla a cabo especialistas formados.</li><li>▶ Para mover el aparato se necesitan dos personas.</li><li>▶ Utilizar únicamente herramientas y equipos apropiados.</li></ul>

	<b>⚠️ PRECAUCIÓN</b>
	<b>¡Bordes o cantos cortantes!</b> Peligro de cortes <ul style="list-style-type: none"><li>▶ Usar guantes de seguridad.</li></ul>

	<b>⚠️ PRECAUCIÓN</b>
	<b>¡Riesgo de que se caigan piezas debido a los tornillos aflojados!</b> Peligro de lesiones debido a piezas que caigan. <ul style="list-style-type: none"><li>▶ Asegure el componente para que no se caiga.</li></ul>

	<b>⚠️ ATENCION</b>
	<b>¡Riesgo de que se caigan piezas debido a los tornillos aflojados!</b> Daños en otras partes del aparato o en el domicilio del consumidor, p. ej., en la parte inferior. <ul style="list-style-type: none"><li>▶ Asegure el componente para que no se caiga.</li></ul>

### Requisito:

- ✔ El aparato está desconectado del suministro eléctrico.
- ✔ Se han separado la puerta del mueble y la del aparato. Véanse las instrucciones de montaje.

### 4.3.1 Desmontar la bisagra deslizante

1. Desatornillar los dos tornillos (1).
2. Retirar la bisagra superior de la puerta superior (2).
3. Retirar la puerta superior (3).
4. Desatornillar los dos tornillos (4).
5. Retirar la bisagra superior de la puerta inferior (5).
6. Retirar la puerta inferior (6).

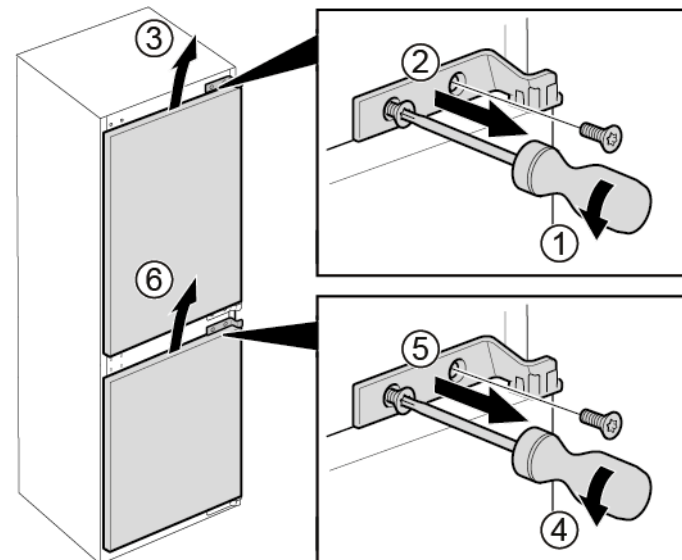

## Reparación

2. 1. Retirar los cuatro tornillos (1).
2. Retirar las bisagras inferiores (2).

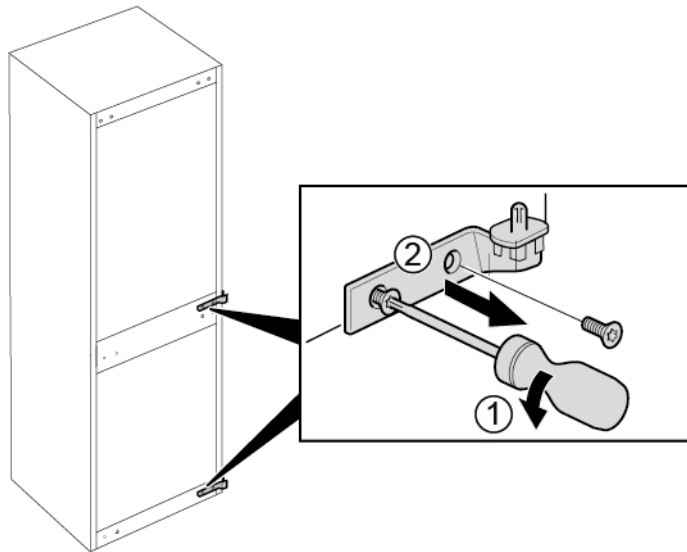

 Se han retirado las bisagras.

### 4.3.2 Montar la bisagra deslizante

- ▶ Montar en orden inverso.

## 4.4 Sustituir el estante de la puerta

### Requisito:

- ✔ La puerta está abierta.

### 4.4.1 Extraer el estante de la puerta

- ▶ Sacar hacia arriba el estante de la puerta.

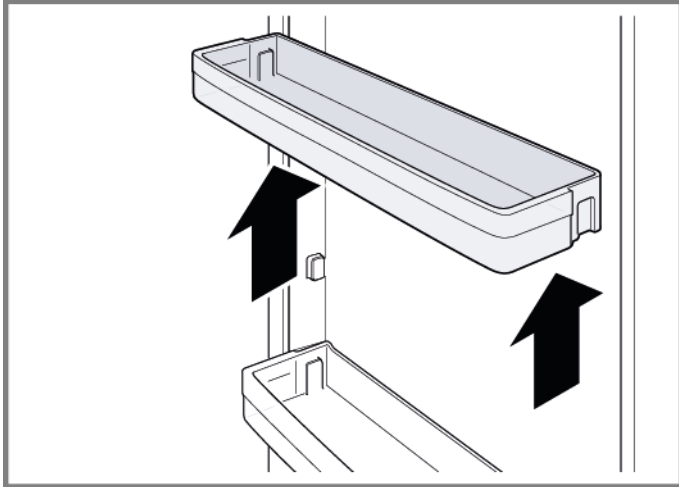

- ➡ Se ha retirado el estante de la puerta.

### 4.4.2 Montar el estante de la puerta

- ▶ Montar en orden inverso.

## 4.5 Sustituir el estante

### Requisito:

- ✔ La puerta está abierta.

### 4.5.1 Extraer el estante

- ▶ Sacar el estante.

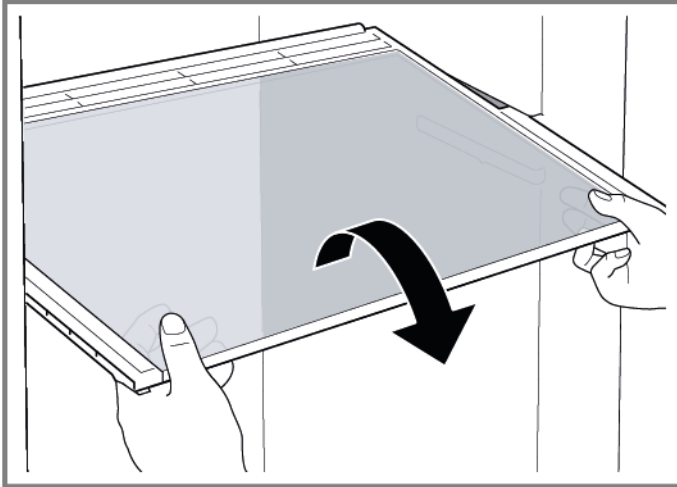

➡ Se ha retirado el estante.

### 4.5.2 Montar el estante

- ▶ Montar en orden inverso.



## 4.6 Sustituir el estante extraíble

### Requisito:

- ✔ La puerta está abierta.

### 4.6.1 Retirar el cajón extraíble

1. Tirar del estante extraíble hasta que la pestaña de bloqueo se suelte.

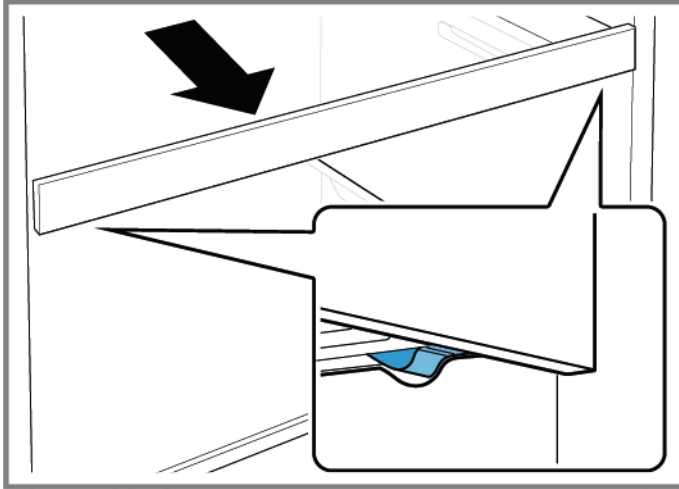

2. Bajar el estante extraíble e inclinarlo a un lado sacándolo.
3. ➡ Se ha retirado el estante extraíble.

### 4.6.2 Montar el estante extraíble

- ▶ Montar en orden inverso.

## 4.7 Sustituir el estante del congelador

### Requisito:

- ✔ La puerta está abierta.

### 4.7.1 Extraer el estante del congelador

- ▶ Tirar del estante del congelador.

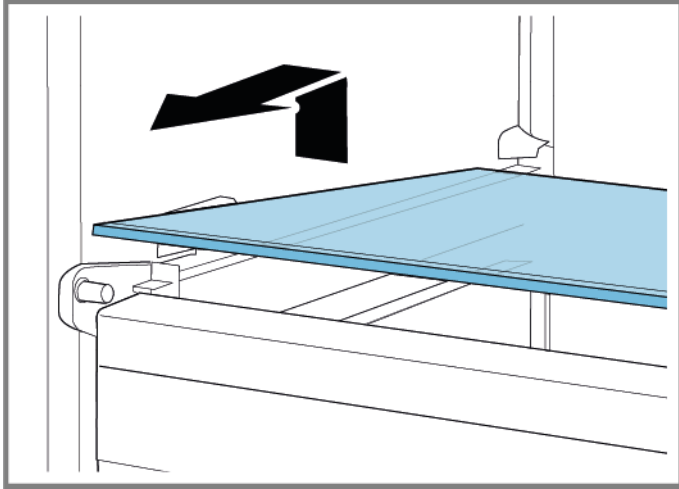

- ➡ Se ha retirado el estante del congelador.

### 4.7.2 Montar el estante del congelador

- ▶ Montar en orden inverso.

## 4.8 Sustituir el cajón de productos congelados

### Requisito:

- ✔ La puerta está abierta.

### 4.8.1 Extraer el cajón de productos congelados

- ▶ 1. Sacar por completo el cajón de productos congelados (1).
- ▶ 2. Extraer el cajón de productos congelados (2).

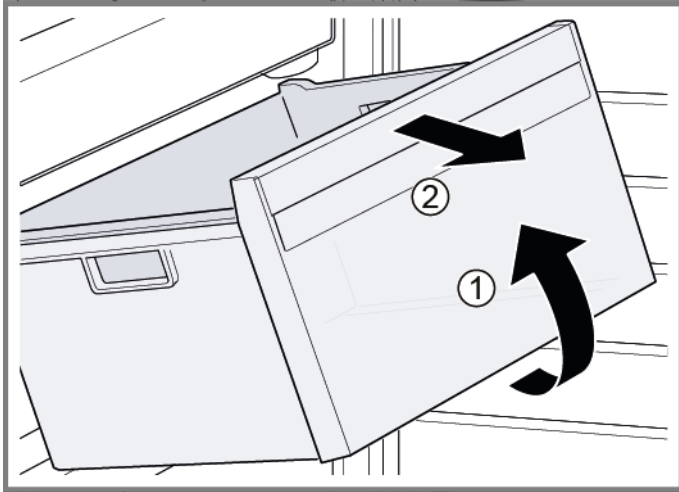

- ➡ Se ha retirado el cajón de productos congelados.

### 4.8.2 Montar el cajón de productos congelados

- ▶ Montar en orden inverso.

## 4.9 Sustituir el cajón para fruta y verdura

### Requisito:

- ✔ La puerta está abierta.

### 4.9.1 Extraer el cajón para fruta y verdura

- ▶ 1. Sacar por completo el cajón (1).
- ▶ 2. Extraer el cajón (2).

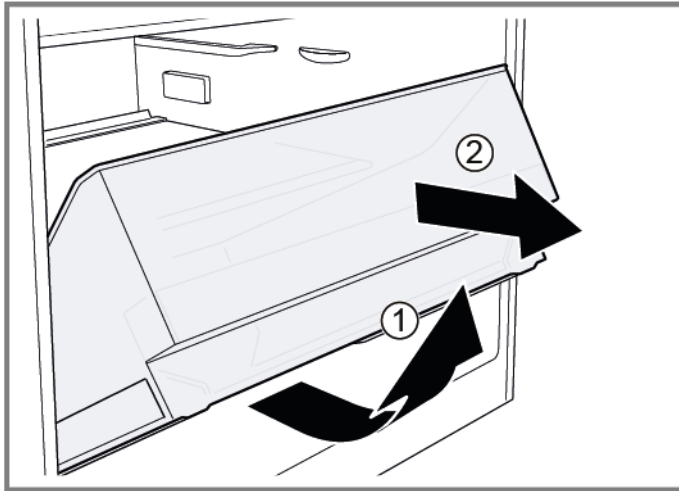

- ➡ Se ha retirado el cajón.

### 4.9.2 Montar el cajón para fruta y verdura

- ▶ Montar en orden inverso.

### 4.10 Sustituir la división y la tapa del cajón para fruta y verdura

#### Requisito:

- ✔ La puerta está abierta.

#### 4.10.1 Retirar la división y la tapa del cajón para fruta y verdura

1. Retirar la placa de cristal de la división.

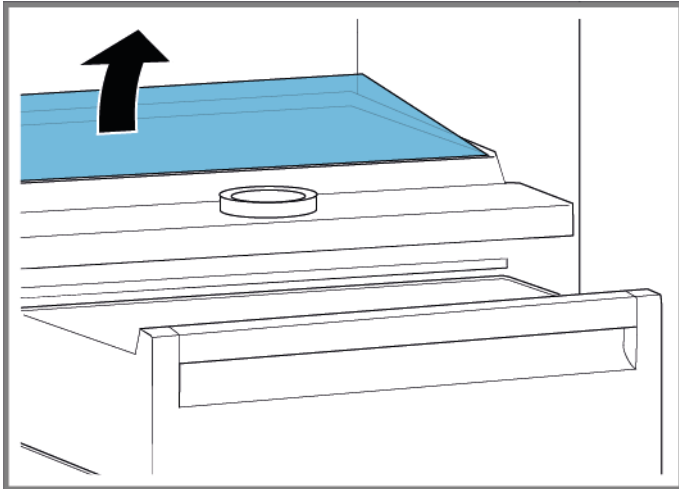

2. [Extraer el cajón para fruta y verdura.→524](#)

3. 1. Presionar la palanca en la parte inferior de los dos lados de la división (1).
2. Sacar la división hacia delante (2).

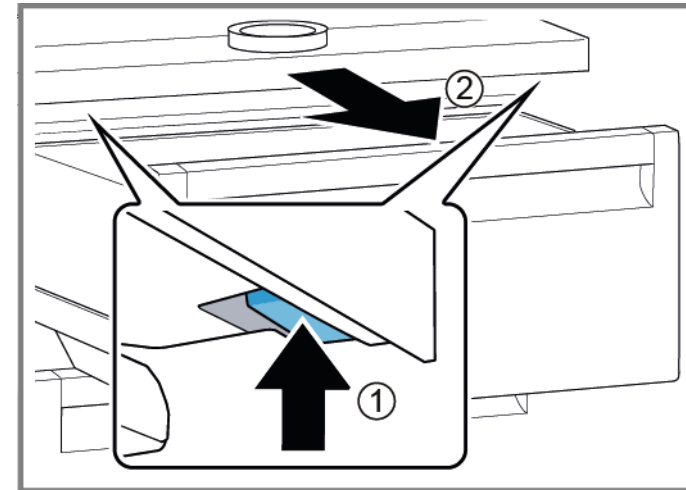

4. Levantar la división e inclinarla hacia el lado sacándola.  
➡ Se ha retirado la división.
5. 1. Levantar la tapa del cajón para fruta y verdura.  
2. Tirar hacia delante de la tapa del cajón para fruta y verdura, e inclinarla hacia el lado sacándola.  
➡ Se ha retirado la tapa del cajón para fruta y verdura.

#### 4.10.2 Montar la división y la tapa del cajón para fruta y verdura

- ▶ Montar en orden inverso.

## 4.11 Sustituir el cajón «Cool-fresh»

### Requisito:

- ✔ La puerta está abierta.

### 4.11.1 Extraer el cajón «Cool-fresh»

- ▶ 1. Inclinar el cajón «Cool-fresh» hacia delante (1).
- ▶ 2. Extraer el cajón «Cool-fresh» (2).

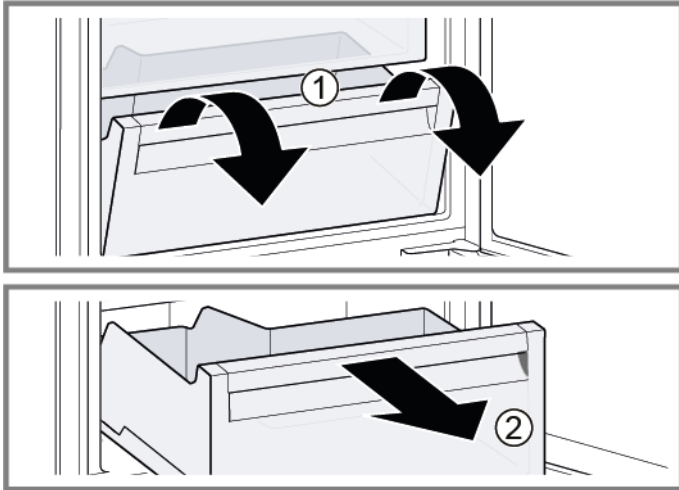

➡ Se ha retirado el cajón «Cool-fresh».

### 4.11.2 Montar el cajón «Cool-fresh»

- ▶ Montar en orden inverso.

## 4.12 Sustituir el cajón extraíble

### Requisito:

- ✔ La puerta está abierta.

### 4.12.1 Retirar el cajón extraíble

- ▶ 1. Inclinar el cajón extraíble hacia delante (1).
- ▶ 2. Retirar el cajón extraíble (2).

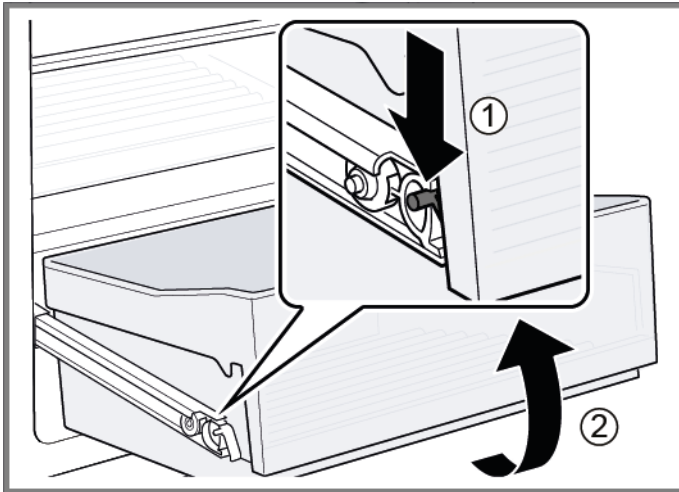

➡ Se ha retirado el cajón extraíble.

### 4.12.2 Montar el cajón extraíble

- ▶ Montar en orden inverso.

## 4.13 Sustituir el foco LED

### Herramientas necesarias:

- Herramienta especial [00342180]
- Destornillador plano Punta 2,4 mm x 0,4 mm x 60 mm, en el kit [00341820]



Su aparato cuenta con una iluminación LED exenta de mantenimiento.  
¡Solo el servicio de atención al cliente o los técnicos autorizados pueden reparar esta iluminación!



### PELIGRO

#### ¡Riesgo de descarga eléctrica debido a piezas con tensión!

Peligro mortal por descarga eléctrica en caso de reparación inadecuada

- Las piezas eléctricas deberían ser reparadas por electricistas cualificados.
- Después de la reparación, encargar una prueba de seguridad conforme a VDE 0701 o los reglamentos específicos del país.



### PELIGRO

#### ¡Riesgo de descarga eléctrica debido a partes con tensión!

Muerte por electrocución

- Desconectar el aparato de la red al menos 60 segundos antes de comenzar con la reparación.



### PRECAUCIÓN

#### ¡Bordes o cantos cortantes!

Peligro de cortes

- Usar guantes de seguridad.

### Requisito:

- El aparato está desconectado del suministro eléctrico.
- La puerta está abierta.
- Se han retirado los estantes del refrigerador.

## 4.13.1 Desmontar el foco LED

- Soltar la tapa del foco LED.

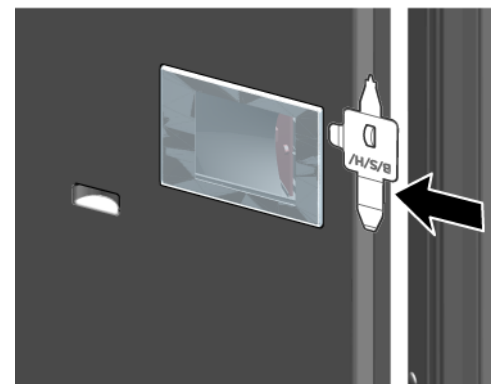

- Tirar de la tapa del foco LED hacia dentro y al mismo tiempo presionar hacia delante.

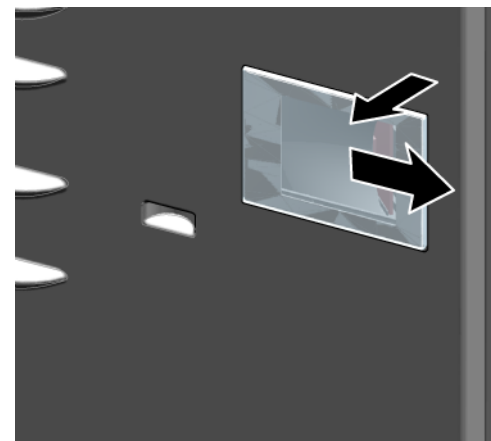



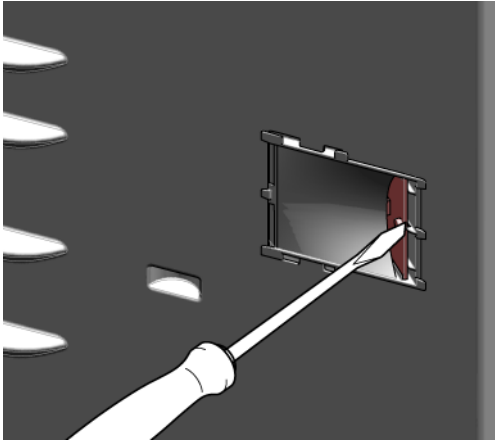

## Reparación

3. Desacoplar el módulo del foco LED.

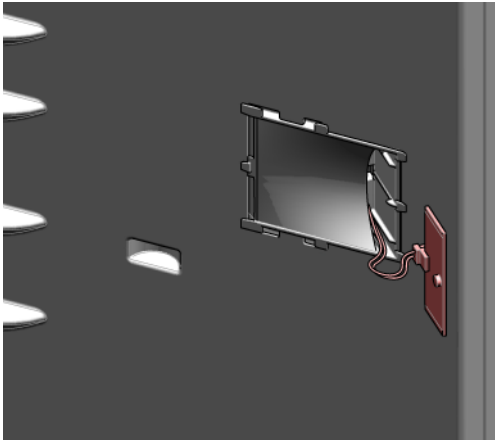

4. Desconectar la conexión eléctrica del foco LED.



 Se ha retirado el foco LED.

### 4.13.2 Montar el foco LED

- ▶ Montar en orden inverso.

# Reparationsinformation - Kyl-/ fryskombination

 <b>Om detta dokument</b> .....	<b>531</b>
1.1 Viktig information.....	531
1.1.1 Syfte .....	531
1.2 Symbolförklaringar.....	531
1.2.1 Faronivåer .....	531
1.2.2 Risksymboler.....	531
1.2.3 Varningarnas struktur.....	532
1.2.4 Allmänna symboler.....	532
 <b>Säkerhet</b> .....	<b>533</b>
2.1 Allmänna säkerhetsanvisningar .....	533
2.1.1 Alla hushållsmaskiner.....	533
 <b>Verktyg och hjälpmedel</b> .....	<b>534</b>
 <b>Reparation</b> .....	<b>535</b>
4.1 Byta dörrpackning.....	535
4.1.1 Ta bort dörrpackning .....	535
4.1.2 Montera dörrpackning .....	535
4.2 Byta platt gångjärn.....	538
4.2.1 Ta bort platt gångjärn .....	538
4.2.2 Montera platt gångjärn .....	540
4.3 Byta glidgångjärn.....	541
4.3.1 Ta bort glidgångjärn .....	541
4.3.2 Montera glidgångjärn.....	542
4.4 Byta dörrhylla .....	543
4.4.1 Ta bort dörrhylla.....	543
4.4.2 Montera dörrhylla .....	543
4.5 Byta hylla .....	544
4.5.1 Ta bort hylla.....	544
4.5.2 Montera hylla.....	544
4.6 Byta utdragbar hylla.....	545
4.6.1 Ta bort utdragbar hylla .....	545
4.6.2 Montera utdragbar hylla.....	545
4.7 Byta frysdelens hylla.....	546
4.7.1 Ta bort frysdelens hylla .....	546
4.7.2 Montera frysdelens hylla.....	546

4.8 Byta fack för frysta matvaror .....	547
4.8.1 Ta bort fack för frysta matvaror.....	547
4.8.2 Montera fack för frysta matvaror .....	547
4.9 Byta frukt- och grönsakslåda.....	548
4.9.1 Ta bort frukt- och grönsakslåda .....	548
4.9.2 Montera frukt- och grönsakslåda .....	548
4.10 Byta skiljeplatta och lock till frukt- och grönsakslåda.....	549
4.10.1 Ta bort skiljeplatta och lock till frukt- och grönsakslåda .....	549
4.10.2 Montera skiljeplatta och lock till frukt- och grönsakslåda.....	549
4.11 Byta cool fresh-fack.....	550
4.11.1 Ta bort cool fresh-fack .....	550
4.11.2 Montera cool fresh-fack .....	550
4.12 Byta utdragbar låda .....	551
4.12.1 Ta bort utdragbar låda .....	551
4.12.2 Montera utdragbar låda.....	551
4.13 Byta LED-spotlight .....	552
4.13.1 Ta bort LED-spotlight .....	552
4.13.2 Montera LED-spotlight .....	553

# i Om detta dokument

## 1.1 Viktig information

### 1.1.1 Syfte

Dessa reparationstips hjälper kunden att själv reparera maskiner enligt gällande ekodesignbestämmelser (som gäller 03/2021).





De innehåller information om hur vissa reservdelar ska bytas samt tillhörande varningar och risker.

Kontakta vår kundtjänst om du har frågor. Vi åtar oss bara ansvar för skador om reparationstipsen har följts korrekt.

## 1.2 Symbolförklaringar

### 1.2.1 Faronivåer

Varningsnivåerna består av en symbol och ett signalord. Signalordet visar hur allvarlig faran är.





Varningsnivå	Innebörd
	Om inte varningsmeddelandet följs kommer det att leda till dödsfall eller allvarliga personskador.
	Om inte varningsmeddelandet följs kan det leda till dödsfall eller allvarliga personskador.
	Om inte varningsmeddelandet följs kan det leda till lättare personskador.
	Om inte varningsmeddelandet följs kan det leda till materialskador.

Grafik 1: Faronivåer



### 1.2.2 Risksymboler

Risksymboler är symboler som visar typen av fara.

Följande risksymboler används i detta dokument:

Risksymbol	Innebörd
	Allmänt varningsmeddelande
	Fara på grund av elektrisk spänning
	Explosionsrisk
	Fara för skärskador
	Fara för krosskador

## i Om detta dokument

Risksymbol	Innebörd
	Fara på grund av heta ytor
	Fara på grund av starka magnetfält
	Fara på grund av icke-joniserande strålning

Grafik 2: Risksymboler

### 1.2.3 Varningarnas struktur

Varningar i detta dokument har ett standardiserat utseende och en standardiserad struktur.



	<p> <b>FARA!</b></p> <p><b>Farans typ och ursprung!</b> Möjliga konsekvenser av att faran/varningen ignoreras.</p> <ul style="list-style-type: none"> <li>▶ Åtgärder och förbud för att förebygga faran.</li> </ul>
--	--





Följande exempel visar en varning som varnar för elstötar från strömförande delar. Det står vilken åtgärd som förebygger faran.

	<p> <b>FARA!</b></p> <p><b>Risk för elstötar på grund av strömförande delar!</b> Dödsfall på grund av elstötar</p> <ul style="list-style-type: none"> <li>▶ Koppla bort maskiner från elförsörjningen minst 60 sekunder innan reparationer påbörjas.</li> </ul>
---	---

### 1.2.4 Allmänna symboler

Följande allmänna symboler används i detta dokument:

Allm. symbol	Innebörd
	Identifiering av ett särskilt tips (text och/eller bild)
	Identifiering av ett enkelt tips (endast text)

Allm. symbol	Innebörd
	Identifiering av en länk till en videohandledning
	Identifiering av verktyg som behövs
	Identifiering av villkor som måste vara uppfyllda
	Identifiering av ett tillstånd (om ..., så ...)
	Identifiering av ett resultat
[Start]	Identifiering av en tangent eller knapp
[00123456]	Identifiering av ett materialnummer
Status	Identifiering av text/fönster som visas (i maskinens display)

Grafik 3: Allmänna symboler

## 2.1 Allmänna säkerhetsanvisningar

### 2.1.1 Alla hushållsmaskiner

#### **Risk för elstötar på grund av strömförande delar!**

- Fel vid reparationer som berör elkomponenter kan orsaka elstötar!
- Koppla bort maskinen från elnätet minst 60 sekunder innan arbetet påbörjas.
- Låt utföra ett säkerhetstest efter reparationen, i enlighet med VDE 0701 eller landsspecifika regler.

#### **Risk för personskador på grund av vassa kanter!**

- Använd skyddshandskar.

#### **Risk för krosskador vid reparation, underhåll, felsökning och service på grund av tunga och rörliga komponenter**

- Använd skyddsskor.
- Säkra tunga komponenter så att de inte faller ner.
- Stick inte in kroppsdelar i rörliga komponenter.



#### **Risk för maskinens säkerhet/funktion!**

- Använd endast originaldelar.

#### **Risk för skador på komponenter känsliga för statisk elektricitet (ESD)!**

- Rör inte modulerna samt anslutningar och strömförande ledningar.

## Verkt yg och hj alpmedel

Beteckning	Detaljer	Bilder
Skyddstrasa [00342013]	60 cm x 50 cm	
Torxbits TX20 [00340865]	6,3 mm (1/4")	
Specialverkt�yg [00342180]		

## 4.1 Byta dörrpackning

### Förutsättning:

- ✔ Dörren är öppen.

### 4.1.1 Ta bort dörrpackning

1. Lossa dörrpackningen från spåret i högra och vänstra hörnet.

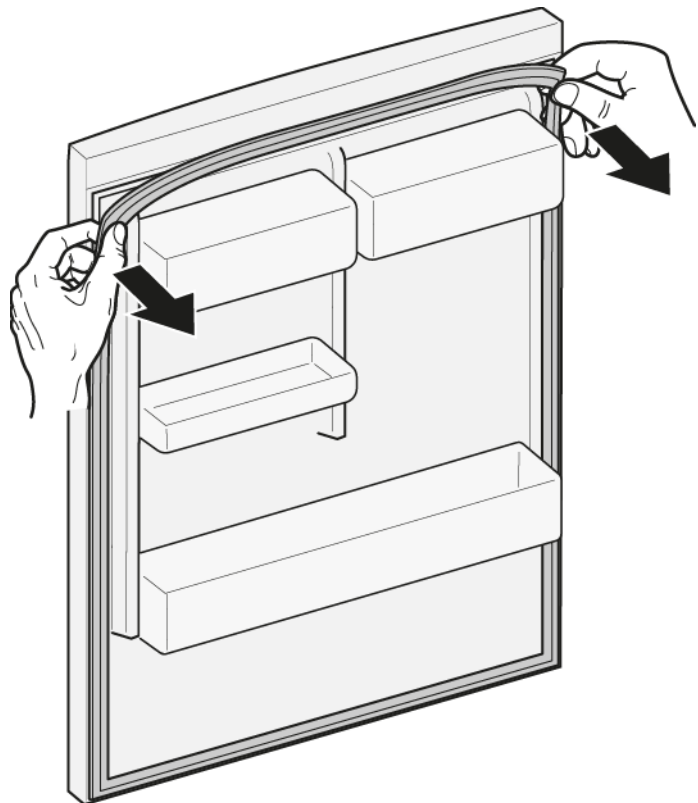

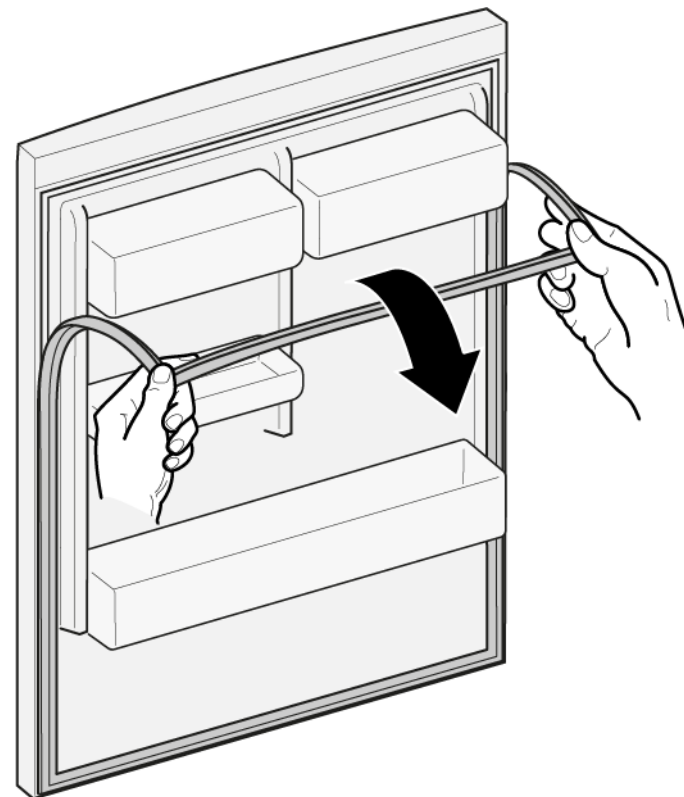

2. Dra ut dörrpackningen från spåret.



- ➡ Dörrpackningen har tagits bort.

### 4.1.2 Montera dörrpackning

	Den nya dörrpackningens tjocklek kan avvika något från den gamla dörrpackningens tjocklek. Detta kommer inte påverka stängningsegenskaperna eller funktionen långsiktigt.
	Om apparaten har justerbara gångjärn eller gångjärnsfästen kan du optimera stängningsegenskaperna senare.
	Små sidohål i dörrpackningen fyller en funktion (krävs för ventilation). Dessa utgör inga tillverkningsfel.

## Reparation

1. Kontrollera om spåret för packningen har skador.

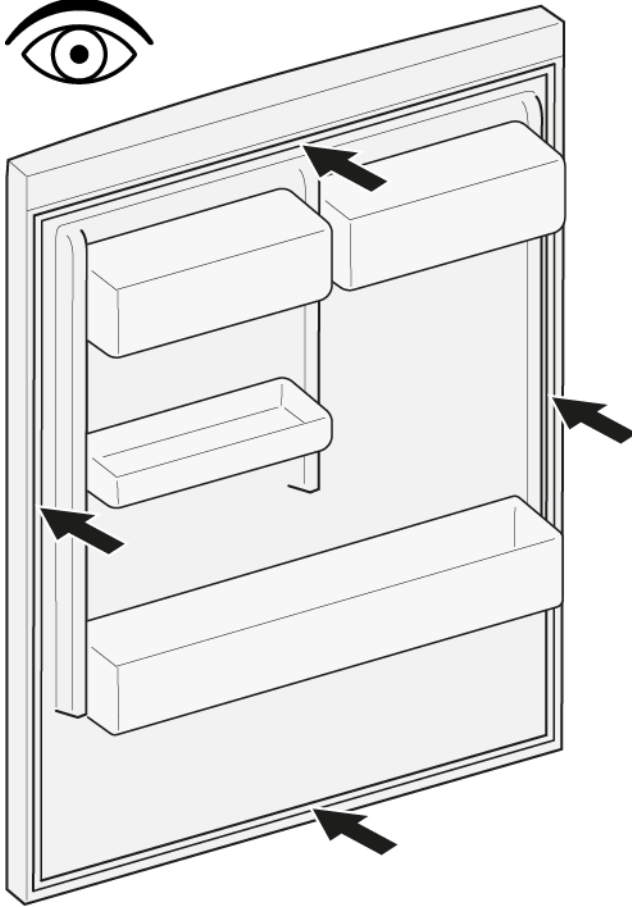

4. Tryck in packningens hörn längst upp och längst ner i spåret.

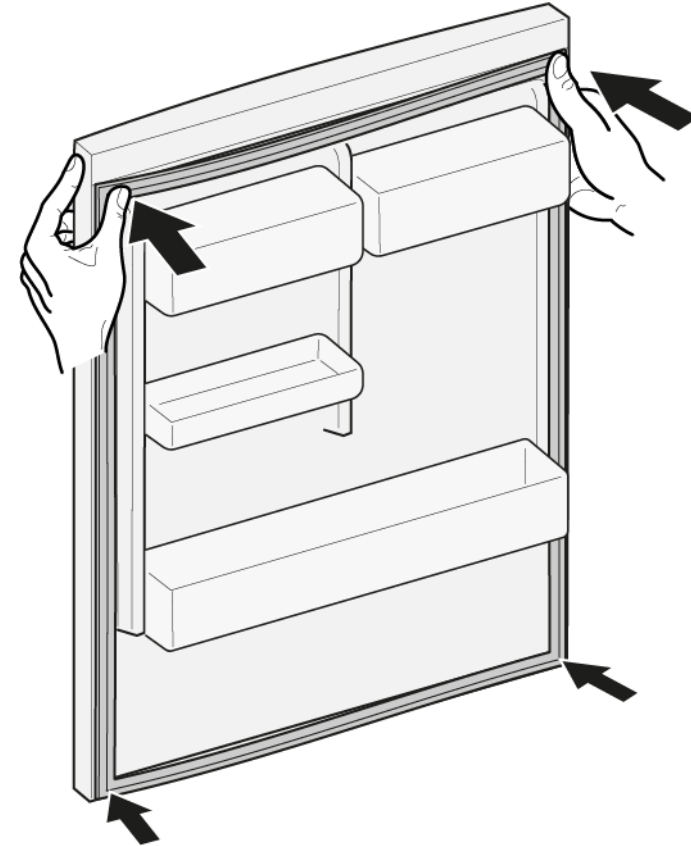

2.  Om spåret för packningen är skadat:
  - Kontakta kundtjänst.

3.  Viss deformation av dörrpackningen är normalt och påverkar inte packningens funktion. Det rekommenderas att man sträcker dörrpackningen innan den sätts in i apparaten.

Värm dörrpackningen med en hårtork eller hett vatten och forma om den med händerna.



## Reparation

5. Tryck in hela packningen i spåret bit för bit.

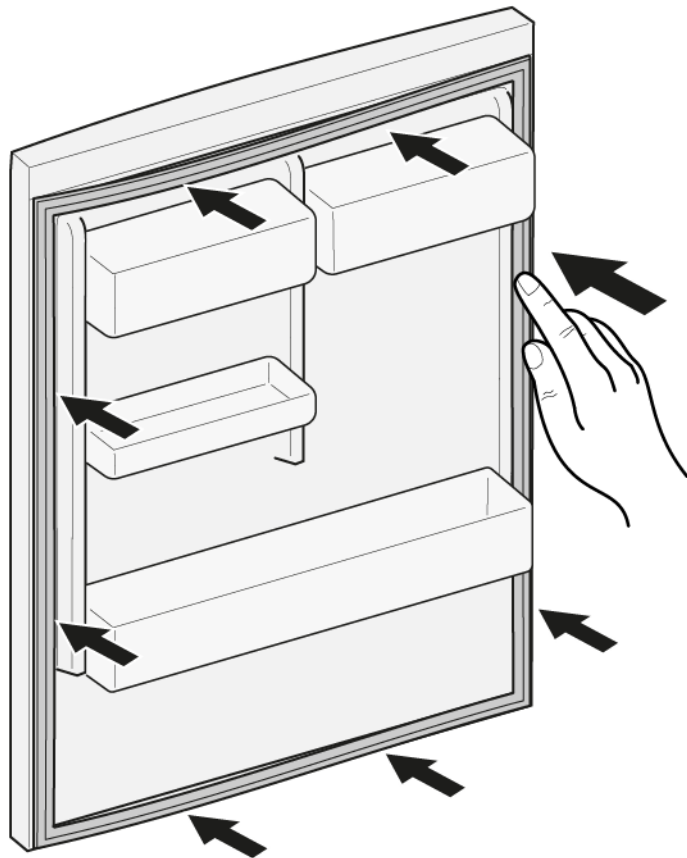

 Dörrpackningen är monterad.

## 4.2 Byta platt gångjärn

### Nödvändiga verktyg:

Torxbits TX20

6,3 mm (1/4")

[00340865]

	<b>⚠ VARNING!</b>
<b>Tunga och skrymmande apparater!</b>	
Rygg- och muskelskador	
<ul style="list-style-type: none"> <li>▶ Låt endast utbildad personal ta bort dörren från apparaten.</li> <li>▶ Det krävs två personer för att flytta apparaten.</li> <li>▶ Använd endast passande verktyg och utrustning.</li> </ul>	

	<b>⚠ FÖRSIKTIGT!</b>
<b>Vassa kanter!</b>	
Skärskador	
<ul style="list-style-type: none"> <li>▶ Använd skyddshandskar.</li> </ul>	

	<b>⚠ FÖRSIKTIGT!</b>
<b>Öppna gångjärnsdelen!</b>	
Risk för att fingrar krossas/fastnar	
<ul style="list-style-type: none"> <li>▶ Stick inte in händerna i gångjärnsdelen.</li> <li>▶ Använd skyddshandskar.</li> </ul>	

	<b>⚠ FÖRSIKTIGT!</b>
<b>Risk för fallande delar på grund av lossade skruvar!</b>	
Personskador på grund av fallande delar.	
<ul style="list-style-type: none"> <li>▶ Säkra komponenter så att de inte faller ner.</li> </ul>	

	<b>OBS!</b>
<b>Risk för fallande delar på grund av lossade skruvar!</b>	
Materiella skador på andra delar av maskinen eller i kundens hem, t.ex. vid botten.	
<ul style="list-style-type: none"> <li>▶ Säkra komponenter så att de inte faller ner.</li> </ul>	

### Förutsättning:

- ✔ Apparaten är bortkopplad från strömförsörjning.
- ✔ Möbeldörren har tagits bort. Se Monteringsanvisning.
- ✔ Dörren är öppen.

### 4.2.1 Ta bort platt gångjärn

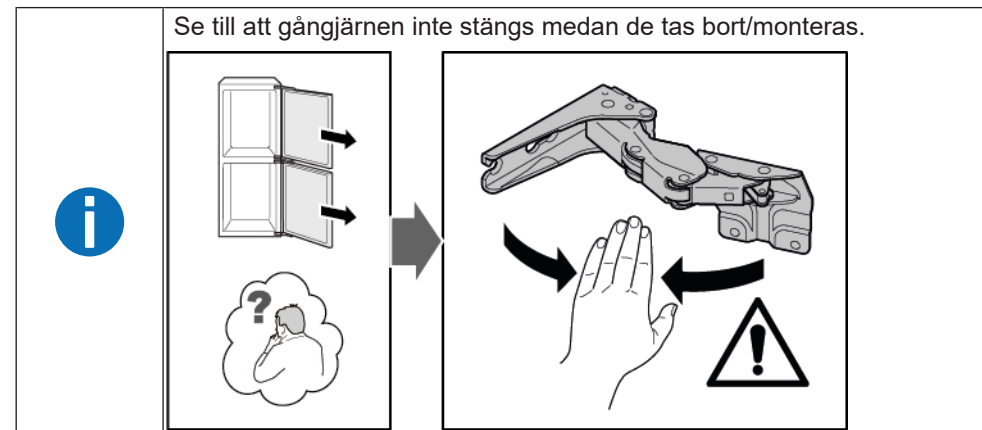

1. Ta bort de fyra gångjärnsskydden.

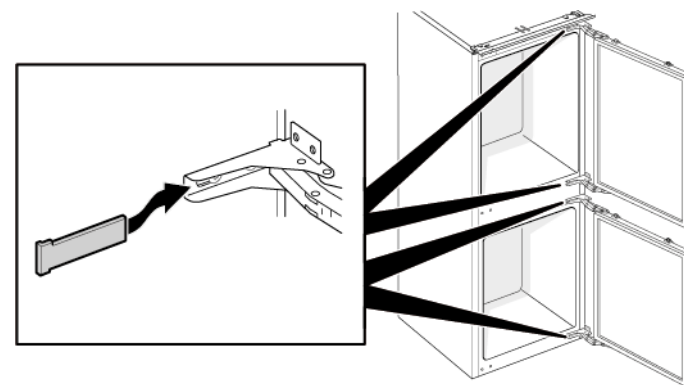

## Reparation

2. 1. Lossa på de fyra skruvarna (1).  
2. Skjut ut och ta bort den övre dörren (2).

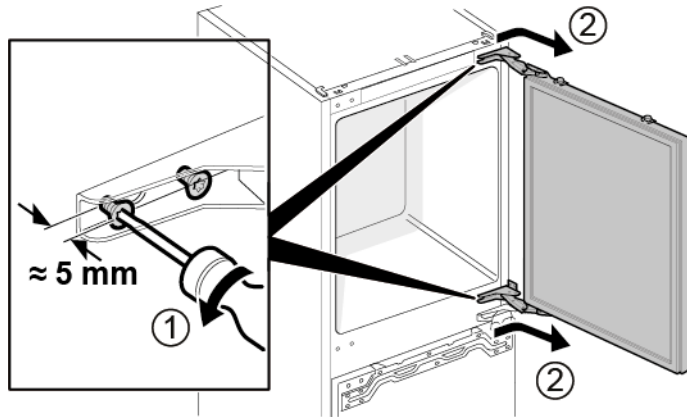

3. 1. Ta bort de fyra skruvarna (1).  
2. Ta bort gångjärnen (2).

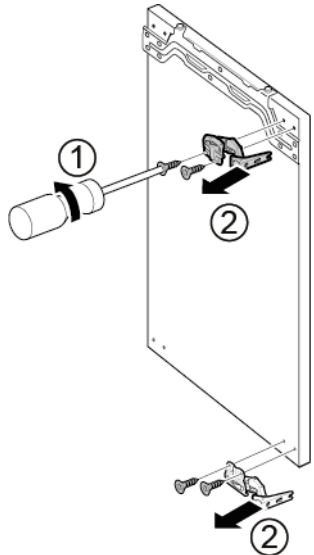

 De övre gångjärnen har tagits bort.

4. 1. Lossa på de fyra skruvarna (1).  
2. Skjut ut och ta bort den nedre dörren (2).

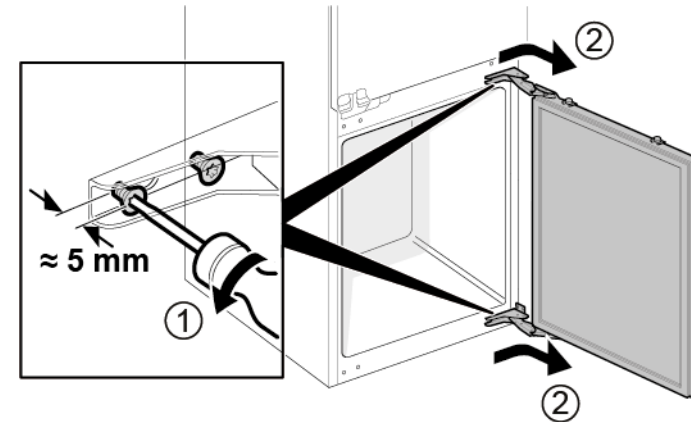

5. 1. Ta bort de fyra skruvarna (1).  
2. Ta bort gångjärnen (2).

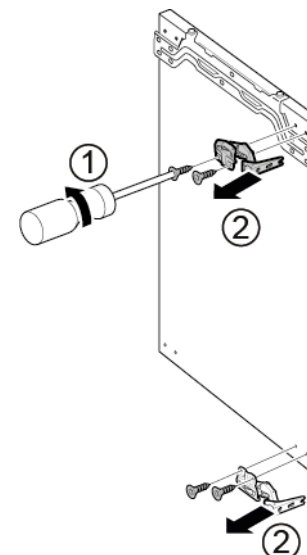

 De nedre gångjärnen har tagits bort.

## **4.2.2 Montera platt gångjärn**

- ▶ Montera i omvänd ordning.

## 4.3 Byta glidgångjärn

### Nödvändiga verktyg:

Torxbits TX20

6,3 mm (1/4")

[00340865]



#### ⚠ VARNING!

#### Tunga och skrymmande apparater!

Rygg- och muskelskador

- ▶ Låt endast utbildad personal ta bort dörren från apparaten.
- ▶ Det krävs två personer för att flytta apparaten.
- ▶ Använd endast passande verktyg och utrustning.



#### ⚠ FÖRSIKTIGT!

#### Vassa kanter!

Skärskador

- ▶ Använd skyddshandskar.



#### ⚠ FÖRSIKTIGT!

#### Risk för fallande delar på grund av lossade skruvar!

Personskador på grund av fallande delar.

- ▶ Säkra komponenter så att de inte faller ner.



#### OBS!

#### Risk för fallande delar på grund av lossade skruvar!

Materiella skador på andra delar av maskinen eller i kundens hem, t.ex. vid botten.

- ▶ Säkra komponenter så att de inte faller ner.

### Förutsättning:

- ✓ Apparaten är bortkopplad från strömförsörjning.
- ✓ Möbeldörren och apparatens dörr är separerade. Se Monteringsanvisning.

## 4.3.1 Ta bort glidgångjärn

1. Skruva ur de två skruvarna (1).
2. Ta bort den övre dörrens övre gångjärn (2).
3. Ta bort den övre dörren (3).
4. Skruva ur de två skruvarna (4).
5. Ta bort den nedre dörrens övre gångjärn (5).
6. Ta bort den nedre dörren (6).

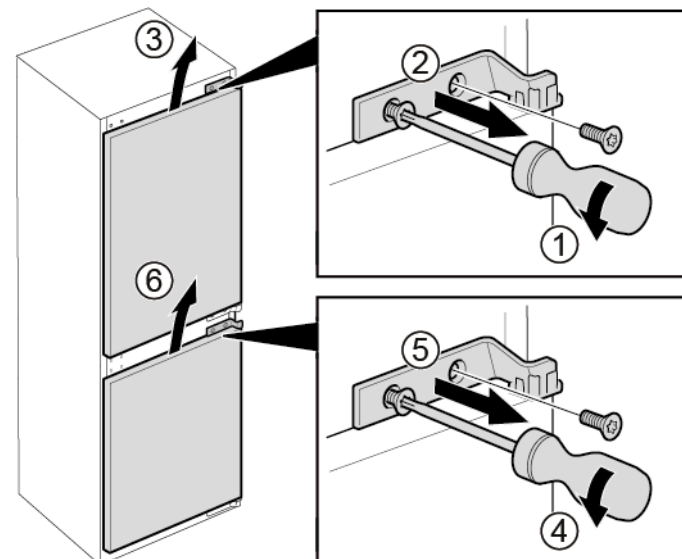

## Reparation

2. 1. Ta bort de fyra skruvarna (1).
2. Ta bort de nedre gångjärnen (2).

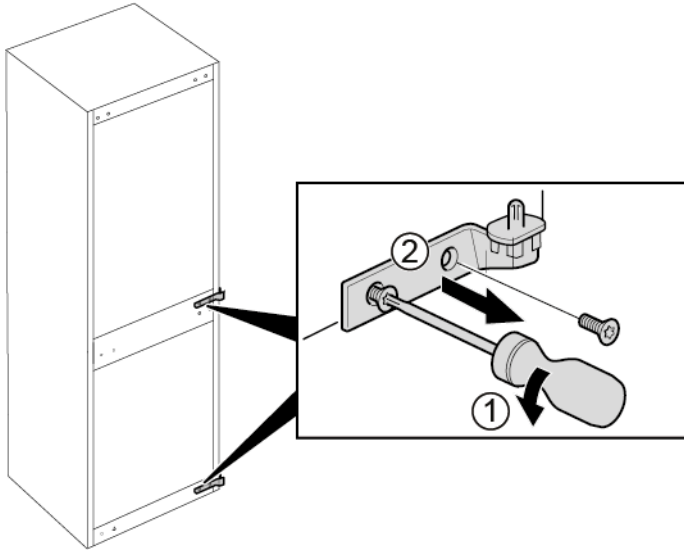

 Gångjärnen har tagits bort.

### 4.3.2 Montera glidgångjärn

- ▶ Montera i omvänd ordning.

## 4.4 Byta dörrhylla

### Förutsättning:

- ✔ Dörren är öppen.

### 4.4.1 Ta bort dörrhylla

- ▶ Lyft dörrhyllan uppåt.

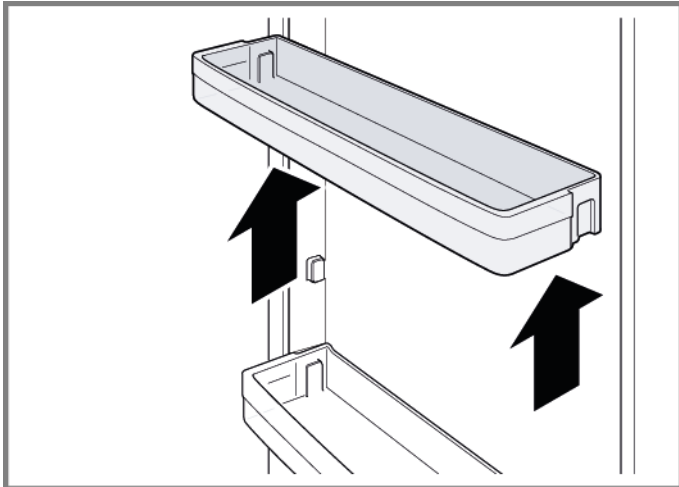

➡ Dörrhyllan har tagits bort.

### 4.4.2 Montera dörrhylla

- ▶ Montera i omvänd ordning.

## 4.5 Byta hylla

### Förutsättning:

- ✔ Dörren är öppen.

### 4.5.1 Ta bort hylla

- ▶ Dra ut hyllan.

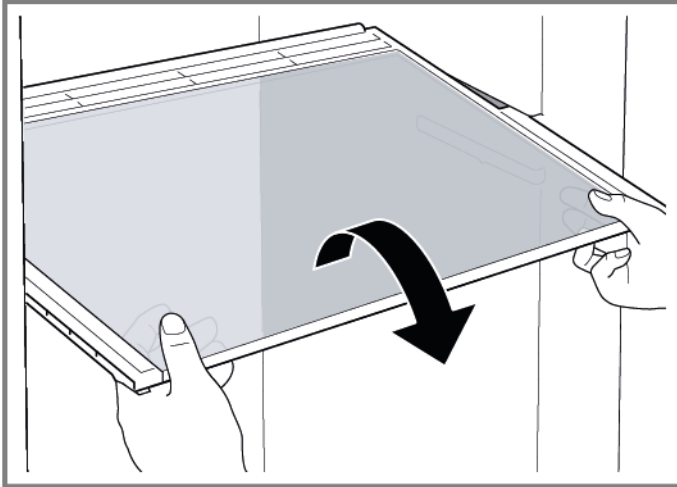

- ➡ Hyllan har tagits bort.

### 4.5.2 Montera hylla

- ▶ Montera i omvänd ordning.



## 4.6 Byta utdragbar hylla

### Förutsättning:

- ✔ Dörren är öppen.

### 4.6.1 Ta bort utdragbar hylla

1. Dra ut den utdragbara hyllan tills låsspärren släpper.

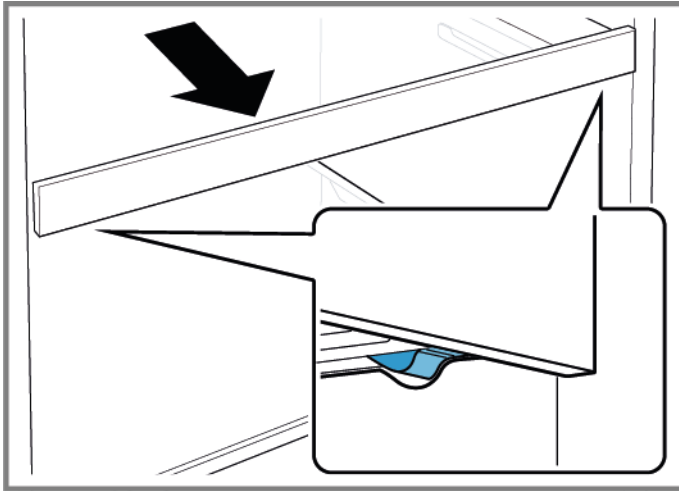

2. Sänk den utdragbara hyllan och sväng ut den åt sidan.
3. ⬅ Den utdragbara hyllan har tagits bort.

### 4.6.2 Montera utdragbar hylla

- ▶ Montera i omvänd ordning.

## 4.7 Byta frysdelens hylla

### Förutsättning:

- ✔ Dörren är öppen.

### 4.7.1 Ta bort frysdelens hylla

- ▶ Dra ut frysdelens hylla.

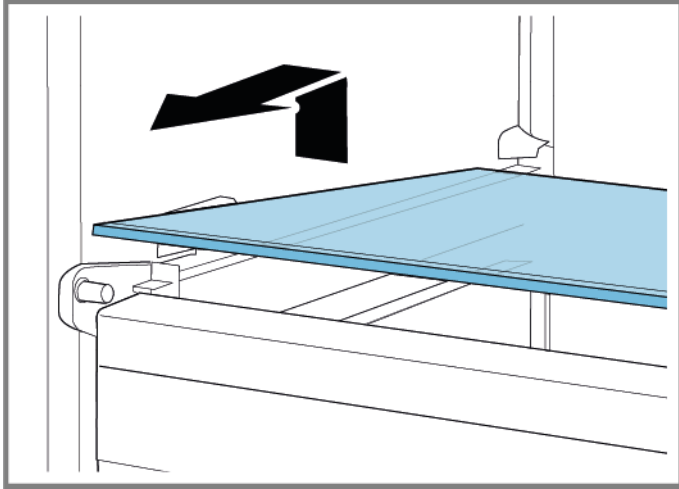

- ➡ Frysdelens hylla har tagits bort.

### 4.7.2 Montera frysdelens hylla

- ▶ Montera i omvänd ordning.

## 4.8 Byta fack för frysta matvaror

### Förutsättning:

- ✔ Dörren är öppen.

### 4.8.1 Ta bort fack för frysta matvaror

- ▶ 1. Dra ut facket för frysta matvaror helt (1).
- ▶ 2. Ta bort facket för frysta matvaror (2).

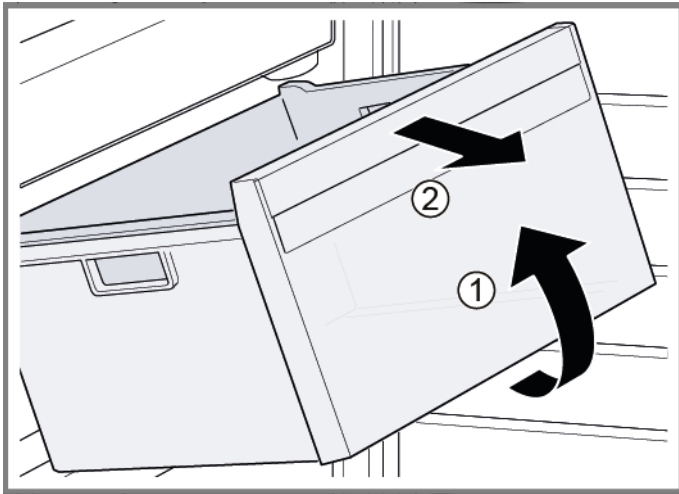

- ➡ Facket för frysta matvaror har tagits bort.

### 4.8.2 Montera fack för frysta matvaror

- ▶ Montera i omvänd ordning.

## 4.9 Byta frukt- och grönsakslåda

### Förutsättning:

- ✔ Dörren är öppen.

### 4.9.1 Ta bort frukt- och grönsakslåda

- ▶ 1. Dra ut lådan helt (1).
- ▶ 2. Ta bort lådan (2).

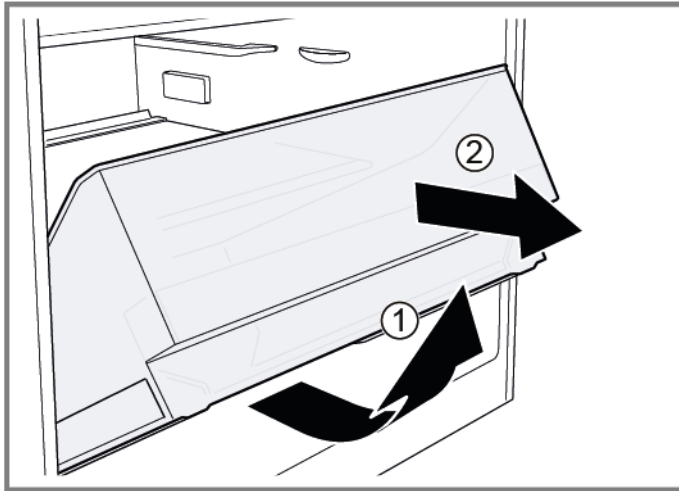

- ➡ Lådan har tagits bort.

### 4.9.2 Montera frukt- och grönsakslåda

- ▶ Montera i omvänd ordning.

## 4.10 Byta skiljeplatta och lock till frukt- och grönsakslåda

### Förutsättning:

- ✔ Dörren är öppen.

### 4.10.1 Ta bort skiljeplatta och lock till frukt- och grönsakslåda

1. Ta bort glasskivan från skiljeplattan.

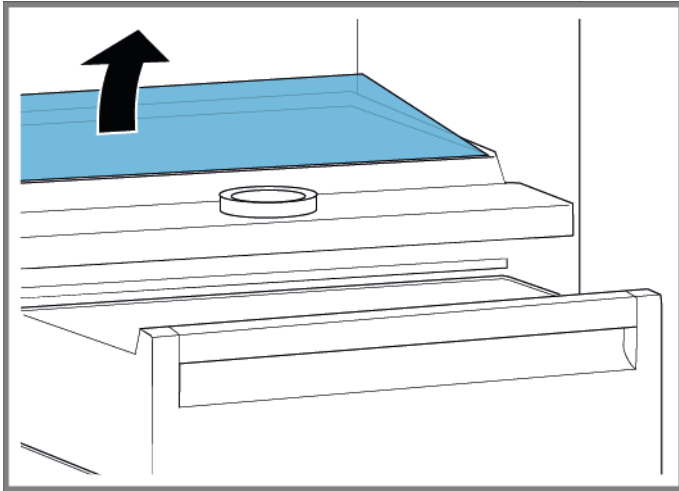

2. [Ta bort frukt- och grönsakslådan.→548](#)

3. 1. Tryck på spaken på undersidan på båda sidorna av skiljeplattan (1).  
2. Dra skiljeplattan framåt (2).

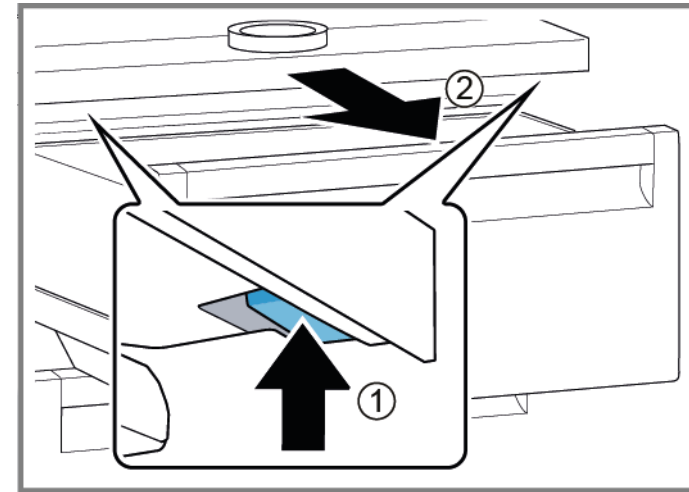

4. Lyft upp skiljeplattan och sväng ut den i sidled.  
➡ Skiljeplattan har tagits bort.
5. 1. Lyft på locket till frukt- och grönsakslådan.  
2. Dra locket till frukt- och grönsakslådan framåt och sväng ut det i sidled.  
➡ Locket till frukt- och grönsakslådan har tagits bort.

### 4.10.2 Montera skiljeplatta och lock till frukt- och grönsakslåda

- ▶ Montera i omvänd ordning.

## 4.11 Byta cool fresh-fack

### Förutsättning:

- ✔ Dörren är öppen.

### 4.11.1 Ta bort cool fresh-fack

- ▶ 1. Luta cool fresh-facket framåt (1).
- ▶ 2. Ta bort cool fresh-facket (2).

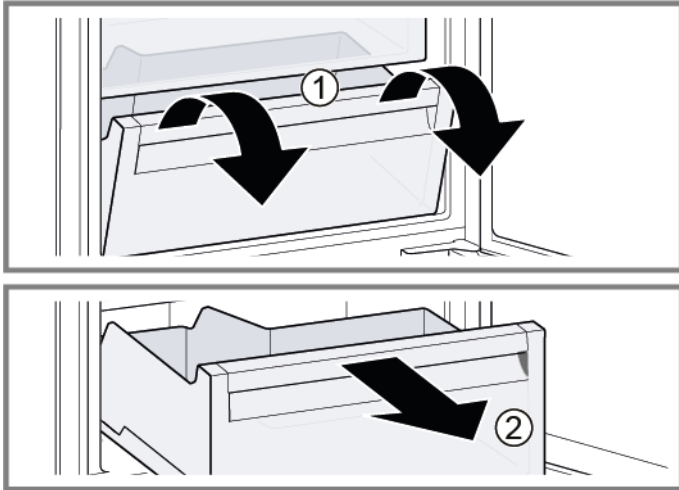

➡ Cool fresh-facket har tagits bort.

### 4.11.2 Montera cool fresh-fack

- ▶ Montera i omvänd ordning.

## 4.12 Byta utdragbar låda

### Förutsättning:

- ✓ Dörren är öppen.

### 4.12.1 Ta bort utdragbar låda

- ▶ 1. Luta den utdragbara lådan framåt (1).
- ▶ 2. Ta bort den utdragbara lådan (2).

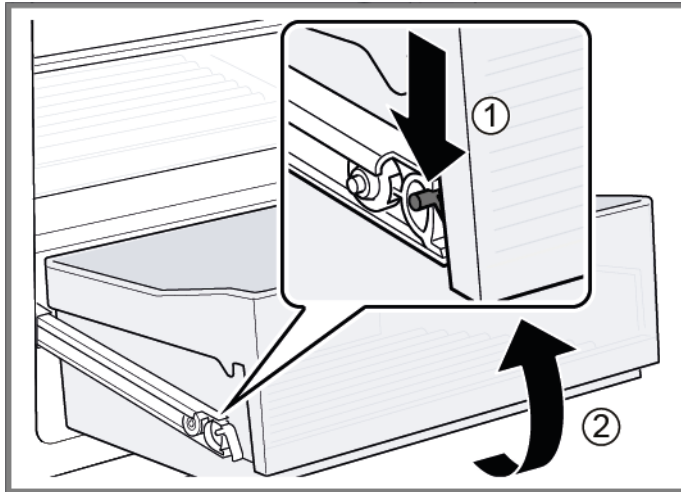

➡ Den utdragbara lådan har tagits bort.

### 4.12.2 Montera utdragbar låda

- ▶ Montera i omvänd ordning.

## 4.13 Byta LED-spotlight

### Nödvändiga verktyg:

- Specialverktyg [00342180]
- Spårskruvmejsel Blad 2,4 mm x 0.4 mm x 60 mm, i kitet [00341820]

**i** Din apparat har en underhållsfri LED-lampa. Dessa lampor får endast bytas av kundtjänst eller auktoriserade tekniker!



### **FARA!**

#### Risk för elstötar på grund av strömförande delar!

Livsfara på grund av elstötar vid felaktiga reparationer

- ▶ Elektriska delar ska repareras av behörig elektriker.
- ▶ Låt utföra ett säkerhetstest efter reparationen, i enlighet med VDE 0701 eller landsspecifika regler.



### **FARA!**

#### Risk för elstötar på grund av strömförande delar!

Dödsfall på grund av elstötar

- ▶ Koppla bort maskiner från elförsörjningen minst 60 sekunder innan reparationer påbörjas.



### **FÖRSIKTIGT!**

#### Vassa kanter!

Skärskador

- ▶ Använd skyddshandskar.

### Förutsättning:

- ✓ Apparaten är bortkopplad från strömförsörjning.
- ✓ Dörren är öppen.
- ✓ Kyldelehyllorna har tagits bort.

## 4.13.1 Ta bort LED-spotlight

1. Lossa LED-spotlightens hölje.

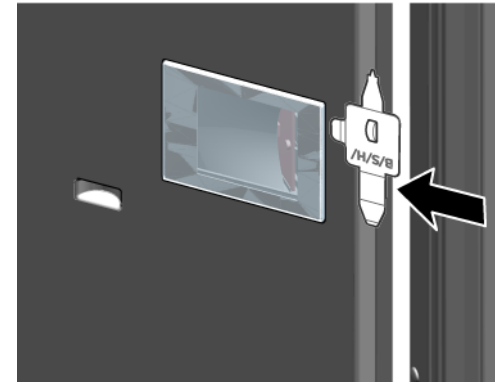

2. Dra LED-spotlightens hölje inåt och tryck samtidigt framåt.

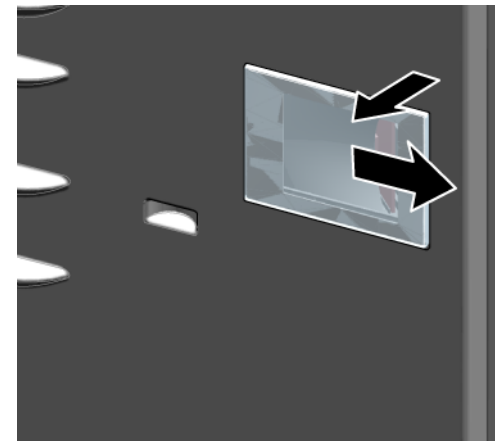



## Reparation

3. Ta loss LED-spotlightmodulen.

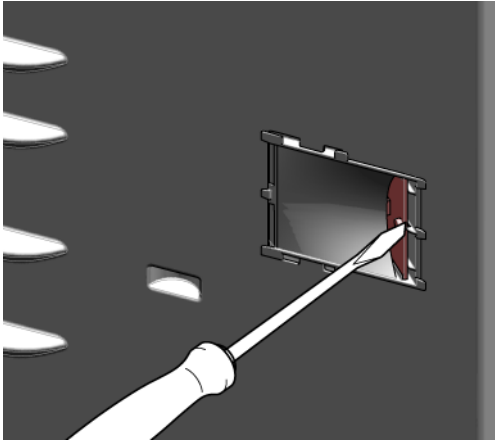

4. Lossa LED-spotlightens elanslutning.

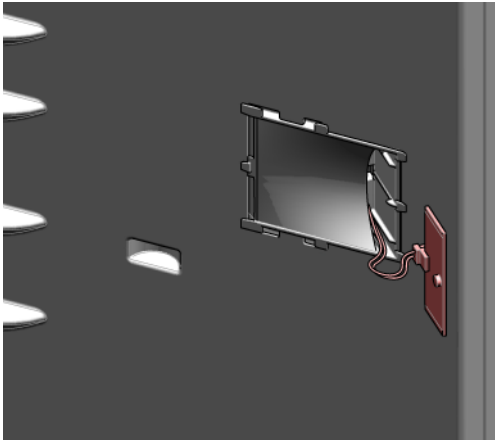

 LED-spotlighten har tagits bort.

### 4.13.2 Montera LED-spotlight

▶ Montera i omvänd ordning.

# Onarım İpuçları - Soğutucu/Dondurucu kombine cihazı

<b>i</b>	<b>Bu doküman hakkında .....</b>	<b>555</b>
1.1	Önemli bilgi .....	555
1.1.1	Amacı.....	555
1.2	Sembollerinin açıklaması .....	555
1.2.1	Tehlike kademeleri .....	555
1.2.2	Tehlike sembolleri .....	555
1.2.3	İkaz bilgilerinin yapısı .....	556
1.2.4	Genel semboller.....	556
<b>⚠</b>	<b>Güvenlik.....</b>	<b>557</b>
2.1	Genel Güvenlik bilgileri .....	557
2.1.1	Tüm ev gereçleri .....	557
<b>🔧</b>	<b>Ekipman ve yardım.....</b>	<b>558</b>
<b>🔧</b>	<b>Onarım.....</b>	<b>559</b>
4.1	Kapı contasının değiştirilmesi .....	559
4.1.1	Kapı contasının çıkartılması.....	559
4.1.2	Kapı contasının takılması .....	559
4.2	Yassı menteşenin değiştirilmesi.....	562
4.2.1	Yassı menteşenin çıkartılması .....	562
4.2.2	Yassı menteşenin takılması .....	564
4.3	Sürgülü menteşenin değiştirilmesi .....	565
4.3.1	Sürgülü menteşenin çıkartılması .....	565
4.3.2	Sürgülü menteşenin takılması .....	566
4.4	Kapı rafının değiştirilmesi .....	567
4.4.1	Kapı rafının çıkartılması.....	567
4.4.2	Kapı rafının takılması .....	567
4.5	Raf yüzeyinin değiştirilmesi .....	568
4.5.1	Raf yüzeyinin çıkartılması .....	568
4.5.2	Raf yüzeyinin takılması.....	568
4.6	Uzatılabilir raf yüzeyinin değiştirilmesi .....	569
4.6.1	Uzatılabilir raf yüzeyinin çıkartılması.....	569
4.6.2	Uzatılabilir raf yüzeyinin takılması .....	569
4.7	Derin dondurucu bölmesi raf yüzeyinin değiştirilmesi .....	570
4.7.1	Derin dondurucu bölmesi raf yüzeyinin çıkartılması .....	570
4.7.2	Derin dondurucu bölmesi raf yüzeyinin takılması.....	570

4.8	Dondurulacak gıda kabının değiştirilmesi.....	571
4.8.1	Dondurulacak gıda kabının çıkartılması .....	571
4.8.2	Dondurulacak gıda kabının takılması .....	571
4.9	Meyve-sebze kabının değiştirilmesi.....	572
4.9.1	Meyve-sebze kabının çıkartılması.....	572
4.9.2	Meyve-sebze kabının takılması .....	572
4.10	Meyve-sebze kabı bölmesinin ve kapağının değiştirilmesi .....	573
4.10.1	Meyve-sebze kabı bölmesinin ve kapağının çıkartılması .....	573
4.10.2	Meyve-sebze kabı bölmesinin ve kapağının takılması .....	573
4.11	Soğutma-taze tutma kabının değiştirilmesi.....	574
4.11.1	Soğutma-taze tutma kabının çıkartılması .....	574
4.11.2	Soğutma-taze tutma kabının takılması .....	574
4.12	Uzatılabilir kabın değiştirilmesi .....	575
4.12.1	Uzatılabilir kabın çıkartılması.....	575
4.12.2	Uzatılabilir kabın takılması .....	575
4.13	LED spot ışığının değiştirilmesi .....	576
4.13.1	LED spot ışığının çıkartılması.....	576
4.13.2	LED spot ışığının takılması .....	577

# **i** Bu doküman hakkında

## 1.1 Önemli bilgi

### 1.1.1 Amacı

Bu onarım ipuçları, tüketicinin cihazları, geçerli eko-tasarım yönetmeliğine göre (03/2021 itibarıyla) kendi başına onarması için destek sunar.

İpuçları, tanımlanmış yedek parçaların nasıl değiştirilmesi gerektiğine dair bilgiler, uyarılar ve söz konusu riskleri içerir.

Sorularınız varsa, lütfen yetkili servisimizle irtibata geçiniz. Yalnızca onarım ipuçlarına gerektiği gibi uyulduğu takdirde hasarlar için sorumluluk üstleniriz.

## 1.2 Sembollerinin açıklaması

### 1.2.1 Tehlike kademeleri

Tehlike kademeleri bir sembolden ve bir sinyal kelimesinden oluşur. Sinyal kelimesi tehlikenin şiddetini ve önemini tanımlar.





Tehlike kademesi	Anlamı
 <b>TEHLİKE</b>	İkaz bilgisinin dikkate alınmaması ölüme veya ağır yaralanmalara sebep olur.
 <b>UYARI</b>	İkaz bilgisinin dikkate alınmaması ölüme veya ağır yaralanmalara sebep olabilir.
 <b>DİKKAT</b>	İkaz bilgisinin dikkate alınmaması hafif yaralanmalara sebep olabilir.
 <b>DİKKATI</b>	İkaz bilgisinin dikkate alınmaması maddi hasarların oluşmasına sebep olabilir.

Tablo 1: Tehlike kademeleri



### 1.2.2 Tehlike sembolleri

Tehlike sembolleri, tehlike türü hakkında bilgi veren anlamlı resimsel gösterimlerdir.

Bu dokümanda aşağıdaki tehlike sembolleri kullanılmıştır:

Tehlike sembolü	Anlamı
	Genel ikaz bilgisi
	Elektrik geriliminden kaynaklanan tehlike
	Patlamadan kaynaklanan tehlike
	Kesmeden dolayı yaralanma tehlikesi
	Sıkışıp ezilmeden dolayı yaralanma tehlikesi

## **i** Bu doküman hakkında

Tehlike sembolü	Anlamı
	Sıcak yüzeylerden kaynaklanan tehlike
	Güçlü elektromanyetik alan tehlikesi
	İyonizasyon olmayan ışınlardan kaynaklanan tehlike

Tablo 2: Tehlike sembolleri

### 1.2.3 İkaz bilgilerinin yapısı

Bu dokümandaki ikaz bilgilerinin standart olarak görünüşü ve yapısı aynıdır.



	<b>⚠ TEHLİKE</b> <b>Tehlikenin türü ve kaynağı!!</b> Tehlike / ikaz bilgisinin dikkate alınmamasının sonucu. ▶ Tehlikeye karşı korunmak için yapılacak işlem ve yasaklar.
--	--







Aşağıdaki örnekte, gerilim ileten parçalar nedeniyle oluşabilecek elektrik çarpması tehlikesi hakkında uyarıda bulunan bir ikaz bilgisi gösterilmiştir. Tehlikeyi önlemek için alınması gereken önlemler belirtilmiştir.

	<b>⚠ TEHLİKE</b> <b>Gerilim ileten parçalar nedeniyle elektrik çarpması tehlikesi!!</b> Elektrik çarpması sebebiyle ölüm ▶ Onarıma başlamadan önce cihazın elektrik şebeke bağlantısını en az 60 saniye süreyle sökün.
---	---

### 1.2.4 Genel semboller

Bu dokümanda aşağıdaki genel semboller kullanılmıştır:

Genel sembol	Anlamı
	Özel ipucu işareti (metin ve/veya grafik)
	Basit ipucu işareti (yalnızca metin)
	Video linki işareti

Genel sembol	Anlamı
	Gerekli araçlar işareti
	Ön koşulların işareti
	Koşul işareti (... olursa .... olur)
	Sonuç işareti
	Tuş veya düğme işareti
	Malzeme numarası işareti
	Gösterilen yazı / ekran işareti (cihaz ekranındaki)

Tablo 3: Genel semboller

## 2.1 Genel Güvenlik bilgileri

### 2.1.1 Tüm ev gereçleri

#### **Gerilim ileten parçalar nedeniyle elektrik çarpması tehlikesi!**

- Elektrikli bileşenlerde yapılan onarımlarda hatalar, elektrik çarpmasına neden olabilir!
- Cihaz çalışmalara başlamadan en az 60 saniye önce elektrik şebekesinden ayrılmalıdır.
- Onarım sonrasında VDE 0701 veya ülkeye özel düzenlemeler uyarınca bir güvenlik testi gerçekleştirilmelidir.

#### **Keskin kenarlar nedeniyle yaralanma tehlikesi!**

- Koruyucu eldiven kullanılmalıdır.

#### **Ağır ve hareketli parçaların onarım, bakım, hata arama ve servis işlemlerinde yaratabileceği ezilme riskleri**

- Koruyucu ayakkabı giyin.
- Yere düşmemesi için ağır parçaları emniyete alın.
- Hareketli parçaların arasına gövde parçaları koymayın.



#### **Cihaz güvenliğinde / fonksiyonda tehlike!**

- Yalnızca orijinal parçalar kullanılmalıdır.

#### **Elektrostatik hassasiyeti olan bileşenlerde hasar tehlikesi (ESD)!**

- Bağlantılar ve iletken yolları da dahil olmak üzere modüllere dokunmayın.

## Ekipman ve yardım

Tanımlama	Detaylar	Görüntüler
Koruyucu bez [00342013]	60 cm x 50 cm	
Torx Bit TX20 [00340865]	6,3 mm (1/4")	
Special tool [00342180]		

## 4.1 Kapı contasının değiştirilmesi

Ön koşul:

- ✓ Kapı açık.

### 4.1.1 Kapı contasının çıkartılması

1. Kapı contasını sağ ve sol köşedeki oluklardan kurtarın.

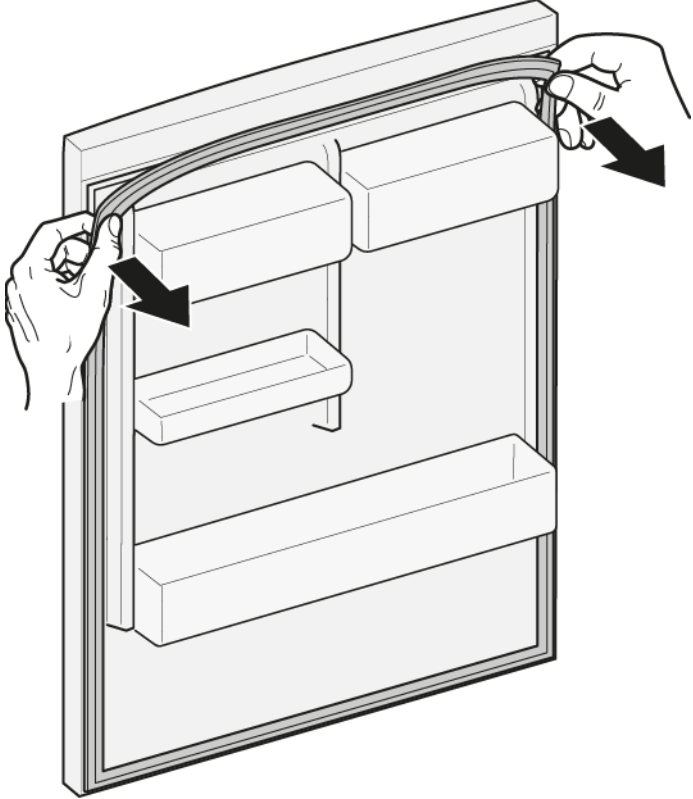

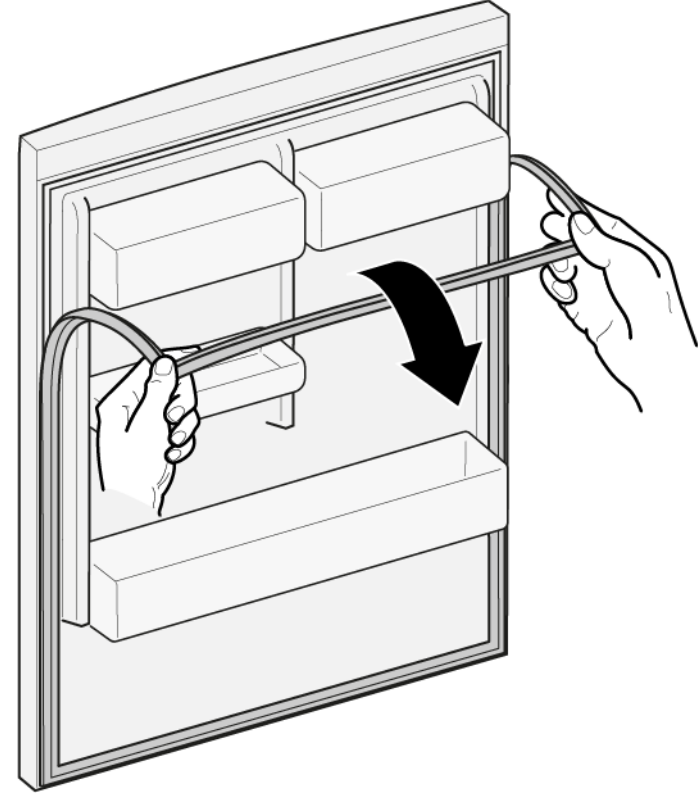

2. Kapı contasını oluktan dışarı çekin.



- ➡ Kapı contası çıkartılmıştır.

### 4.1.2 Kapı contasının takılması

	Yeni kapı contasının kalınlığı, eski kapı contasının kalınlığından biraz farklı olabilir. Bu, kapının kapanma özelliğini ve uzun süreli işlevini etkilemez.
	Cihazınızda ayarlanabilir menteşeler veya menteşe ekleri varsa, kapının kapanma özelliğini daha sonra optimize edebilirsiniz.
	Kapı contasındaki küçük yan delikler işlevseldir (havalandırma için gereklidir). Bunlar üretim hatası değildir.

1. Conta için oluğu hasar bakımından kontrol edin.

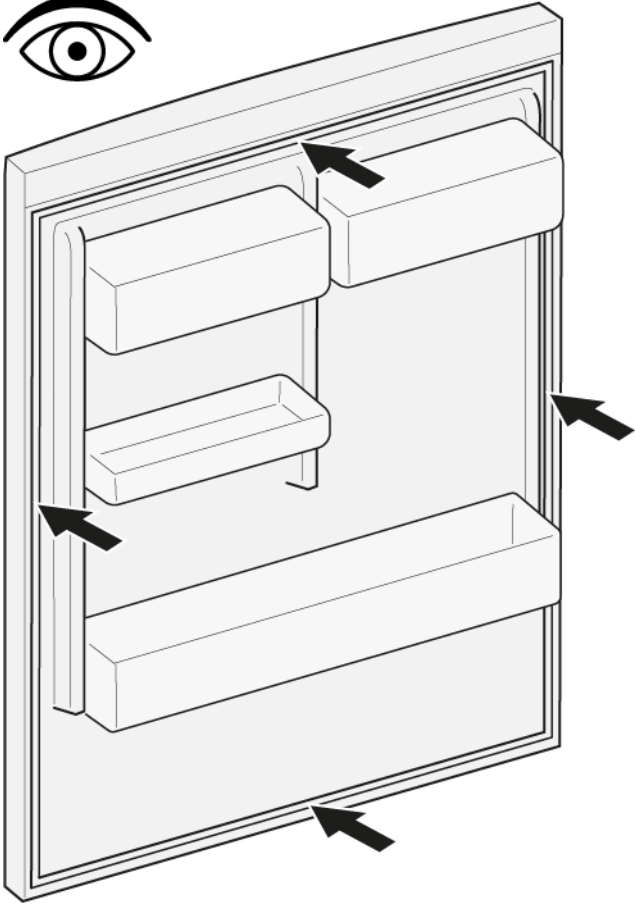

4. Contanın köşelerini üstten ve alttan oluğa itin.

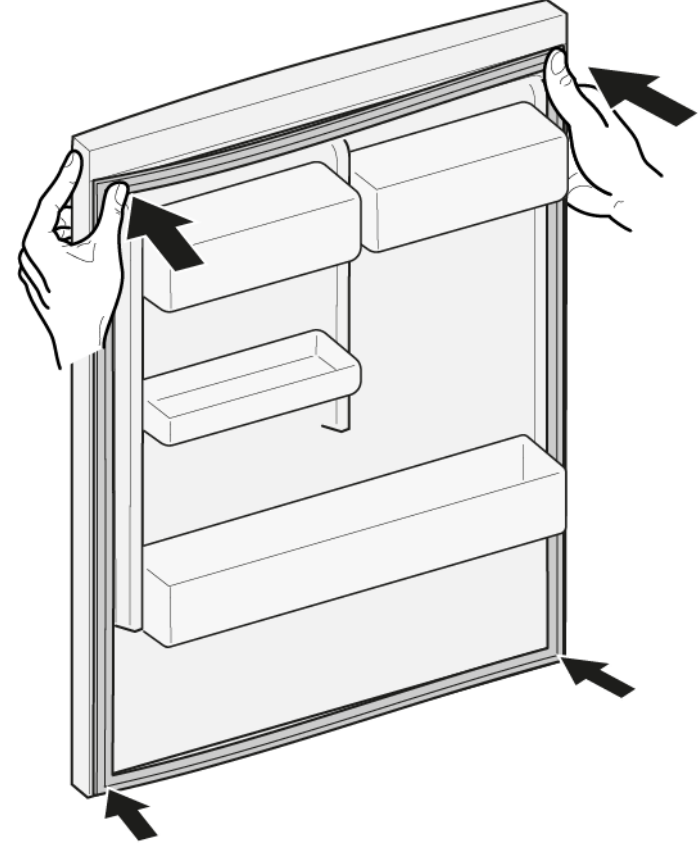

2.  Conta için oluk hasarlı ise,  
- Müşteri hizmetleriyle irtibata geçin.

3.  Kapı contasında hafif deformasyon normaldir ve contanın işlevini etkilemez. Kapı contasını cihaza yerleştirmeden önce contanın düzleştirilmesi önerilir.

Kapı contasını bir saç kurutma makinesi veya sıcak suyla ısıtın ve manuel olarak şekillendirin.



5. Contanın tamamını adım adım oluğun içine bastırın.

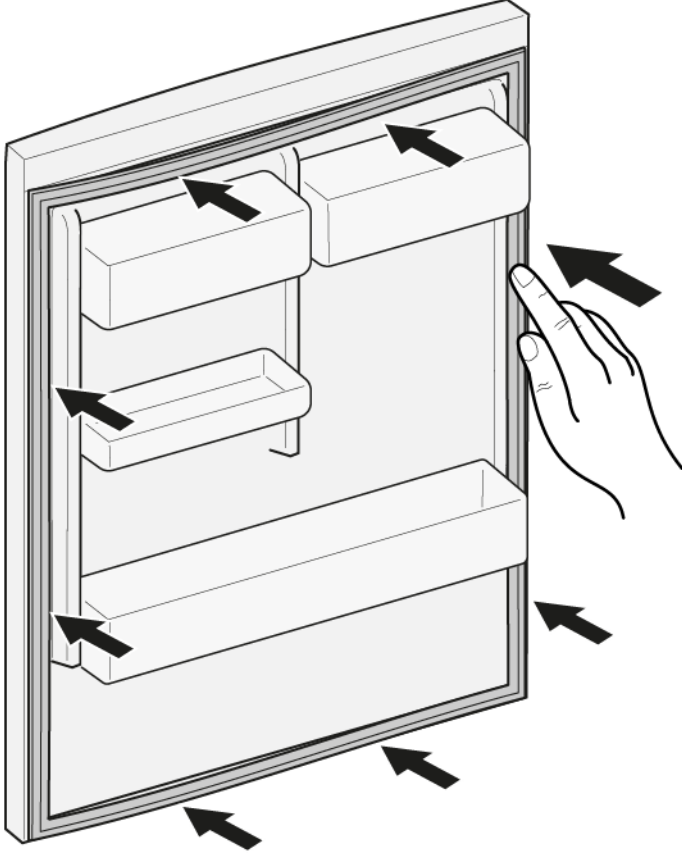

 Kapı contası takılmıştır.

## 4.2 Yassı menteşenin değiştirilmesi

Özel yardımcı ekipman:

 Torx Bit TX20

6,3 mm (1/4")

[00340865]



### UYARI

#### Ağır, büyük cihazlar!

Sırt ve kas yaralanmaları

- ▶ Cihaz kapısını çıkarma işlemi sadece eğitimli uzmanlar tarafından gerçekleştirilmelidir.
- ▶ Cihazı hareket ettirmek için iki kişi gereklidir.
- ▶ Sadece uygun aletler ve ekipmanlar kullanın.



### DİKKAT

#### Keskin köşeler!

Kesik yaralanmaları

- ▶ Koruyucu eldiven kullanılmalıdır.



### DİKKAT

#### Açık menteşe bölgesi!

Parmakların ezilmesi / sıkışması

- ▶ Menteşe bölgesine elinizi sokmayın.
- ▶ Koruyucu eldiven kullanılmalıdır.



### DİKKAT

#### Vidaların gevşetilmesi nedeniyle parçaların düşme tehlikesi!

Düşen parçalar nedeniyle yaralanma.

- ▶ Bileşenleri düşmeye karşı emniyete alın.





### DİKKAT!

#### Vidaların gevşetilmesi nedeniyle parçaların düşme tehlikesi!

Cihazın diğer parçalarında veya müşterinin evinde (örn. zemin) hasarlar.

- ▶ Bileşenleri düşmeye karşı emniyete alın.

Ön koşul:

-  Cihazın fişi çekilir.
-  Mobilya kapısı çıkartılmıştır. Bkz. Montaj Talimatı.
-  Kapı açık.

## 4.2.1 Yassı menteşenin çıkartılması



1. Dört menteşe kapağını çıkartın.

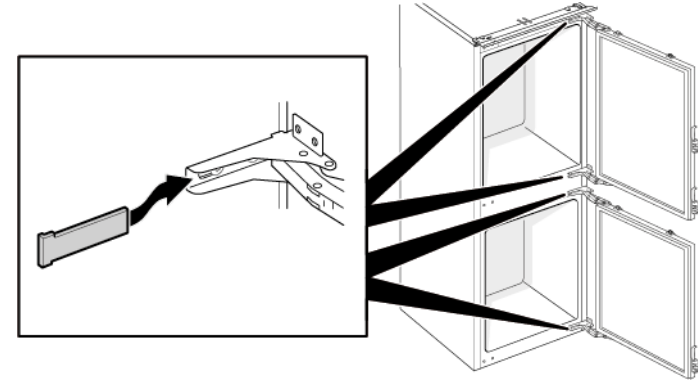

1. Dört vidayı gevşetin (1).
2. Üst kapıyı dışarı kaydırarak çıkartın (2).

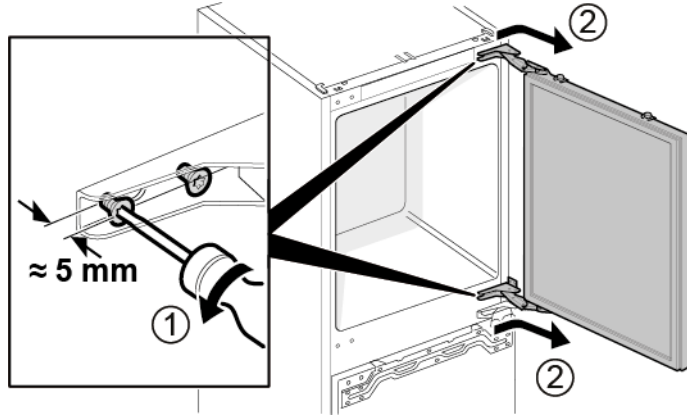

1. Dört vidayı sökün (1).
2. Menteşeleri çıkartın (2).

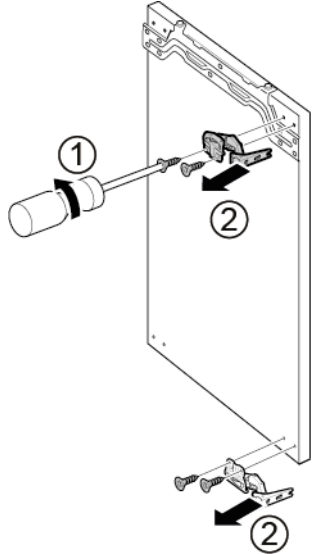

➡ Üst kapı menteşeleri çıkartılmıştır.

1. Dört vidayı gevşetin (1).
2. Alt kapıyı dışarı kaydırarak çıkartın (2).

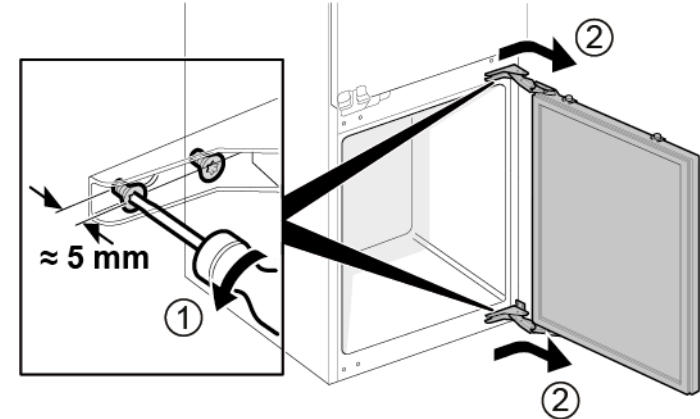

1. Dört vidayı sökün (1).
2. Menteşeleri çıkartın (2).

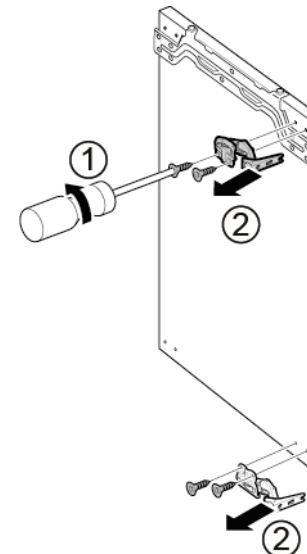

➡ Alt kapı menteşeleri çıkartılmıştır.

#### **4.2.2 Yassı menteşenin takılması**

- ▶ Ters sıra ile monte edin.

## 4.3 Sürgülü menteşenin değiştirilmesi

Özel yardımcı ekipman:

Torx Bit TX20

6,3 mm (1/4")

[00340865]



### UYARI

#### Ağır, büyük cihazlar!

Sırt ve kas yaralanmaları

- ▶ Cihaz kapısını çıkarma işlemi sadece eğitimli uzmanlar tarafından gerçekleştirilmelidir.
- ▶ Cihazı hareket ettirmek için iki kişi gereklidir.
- ▶ Sadece uygun aletler ve ekipmanlar kullanın.



### DİKKAT

#### Keskin köşeler!

Kesik yaralanmaları

- ▶ Koruyucu eldiven kullanılmalıdır.



### DİKKAT

#### Vidaların gevşetilmesi nedeniyle parçaların düşme tehlikesi!

Düşen parçalar nedeniyle yaralanma.

- ▶ Bileşenleri düşmeye karşı emniyete alın.



### DİKKAT!

#### Vidaların gevşetilmesi nedeniyle parçaların düşme tehlikesi!

Cihazın diğer parçalarında veya müşterinin evinde (örn. zemin) hasarlar.

- ▶ Bileşenleri düşmeye karşı emniyete alın.

Ön koşul:

- ✔ Cihazın fişi çekilir.
- ✔ Mobilya kapısı ve cihaz kapısı ayrıdır. Bkz. Montaj Talimatı.

## 4.3.1 Sürgülü menteşenin çıkartılması

1. Vidaları sökün (1).
2. Üst kapının üst menteşesini çıkartın (2).
3. Üst kapıyı sökün (3).
4. Vidaları sökün (4).
5. Alt kapının üst menteşesini çıkartın (5).
6. Alt kapıyı sökün (6).

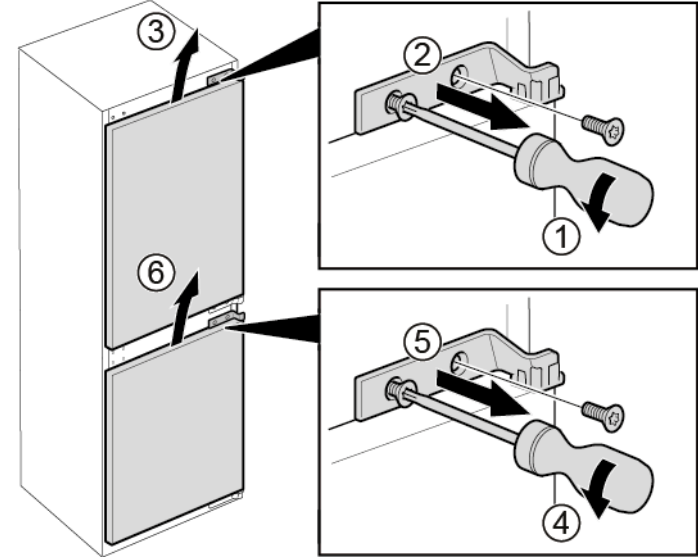

2. 1. Dört vidayı sökün (1).
2. Alt menteşeleri çıkartın (2).

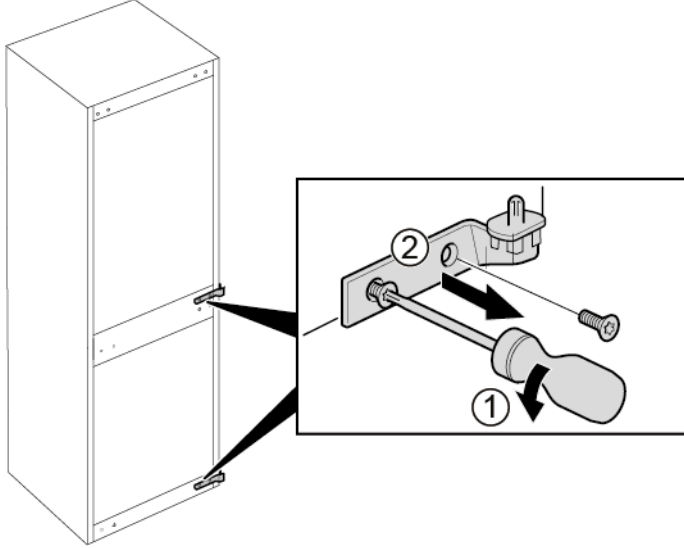

 Menteşeler çıkartılmıştır.

### 4.3.2 Sürgülü menteşenin takılması

- ▶ Ters sıra ile monte edin.

#### 4.4 Kapı rafının değiştirilmesi

Ön koşul:

- ✔ Kapı açık.

##### 4.4.1 Kapı rafının çıkartılması

- ▶ Kapı rafını yukarıya doğru kaldırın.

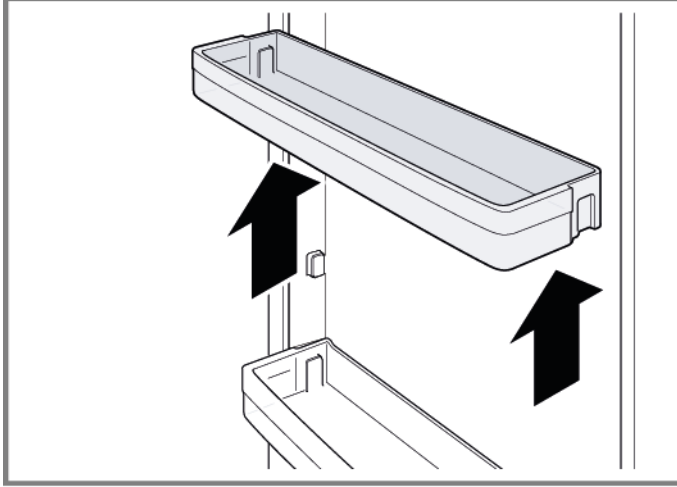

➡ Kapı rafı çıkartılmıştır.

##### 4.4.2 Kapı rafının takılması

- ▶ Ters sıra ile monte edin.

## 4.5 Raf yüzeyinin değiştirilmesi

Ön koşul:

- ✔ Kapı açık.

### 4.5.1 Raf yüzeyinin çıkartılması

- ▶ Raf yüzeyini dışarı çekin.

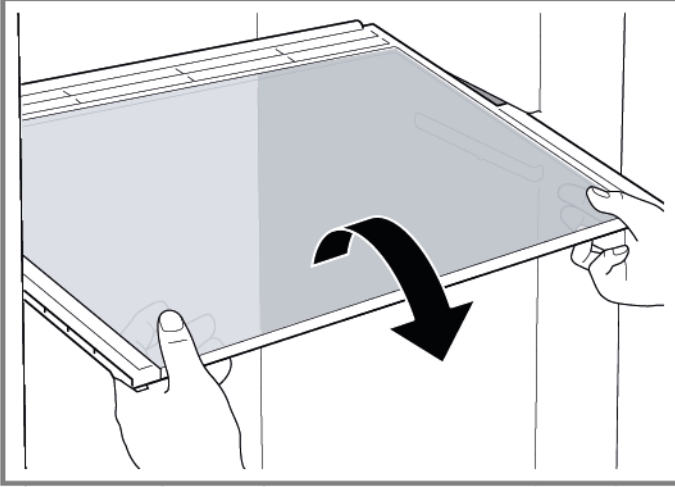

➡ Raf yüzeyi çıkartılmıştır.

### 4.5.2 Raf yüzeyinin takılması

- ▶ Ters sıra ile monte edin.



## 4.6 Uzatılabilir raf yüzeyinin değiştirilmesi

Ön koşul:

- ✔ Kapı açık.

### 4.6.1 Uzatılabilir raf yüzeyinin çıkartılması

1. Uzatılabilir raf yüzeyini kilitleme tırnağı serbest kalana dek dışarı çekin.

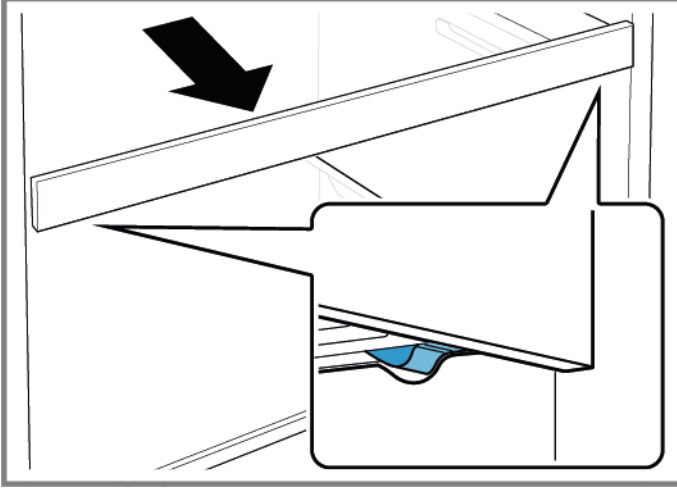

2. Uzatılabilir raf yüzeyini aşağı indirin ve yana doğru döndürerek çıkartın.
3. ➡ Uzatılabilir raf yüzeyi çıkartılmıştır.

### 4.6.2 Uzatılabilir raf yüzeyinin takılması

- ▶ Ters sıra ile monte edin.

## 4.7 Derin dondurucu bölmesi raf yüzeyinin değiştirilmesi

Ön koşul:

- ✔ Kapı açık.

### 4.7.1 Derin dondurucu bölmesi raf yüzeyinin çıkartılması

- ▶ Derin dondurucu bölmesi raf yüzeyini dışarı çekin.

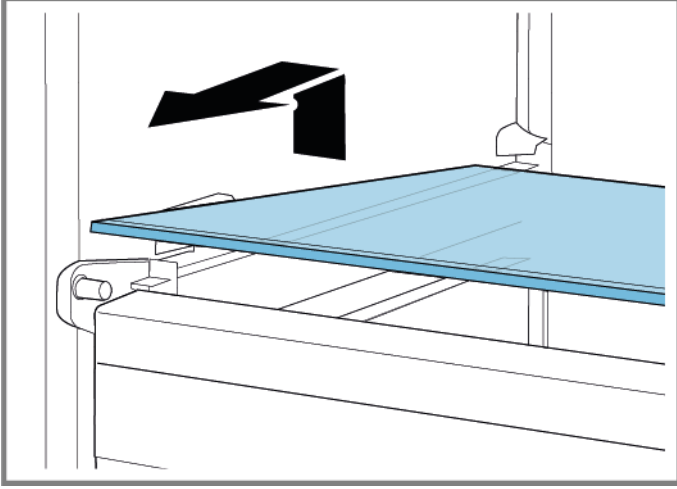

- ➡ Derin dondurucu bölmesi raf yüzeyi çıkartılmıştır.

### 4.7.2 Derin dondurucu bölmesi raf yüzeyinin takılması

- ▶ Ters sıra ile monte edin.

## 4.8 Dondurulacak gıda kabının deęiřtirilmesi

Ön koşul:

- ✓ Kapı açık.

### 4.8.1 Dondurulacak gıda kabının çıkartılması

- ▶ 1. Dondurulacak gıda kabını tamamen dışarı çekin (1).
- ▶ 2. Dondurulacak gıda kabını çıkartın (2).

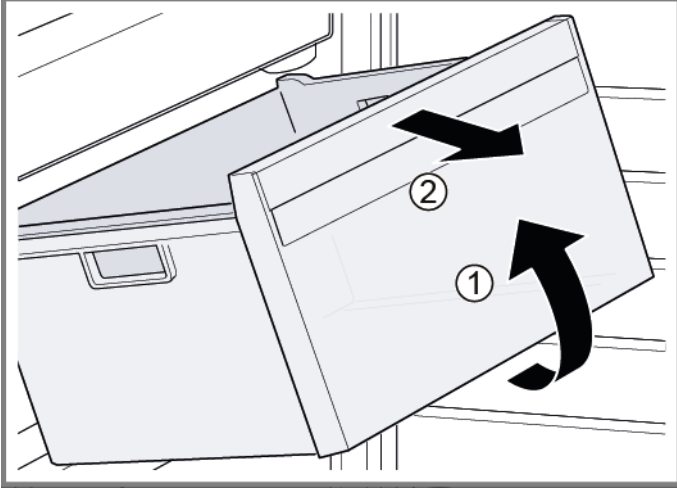

- ➡ Dondurulacak gıda kabı çıkartılmıştır.

### 4.8.2 Dondurulacak gıda kabının takılması

- ▶ Ters sıra ile monte edin.

## 4.9 Meyve-sebze kabının deęiřtirilmesi

Ön koęul:

- ✓ Kapı açık.

### 4.9.1 Meyve-sebze kabının çıkartılması

- ▶ 1. Kabı tamamen dışarı çekin (1).
- ▶ 2. Kabı çıkartın (2).

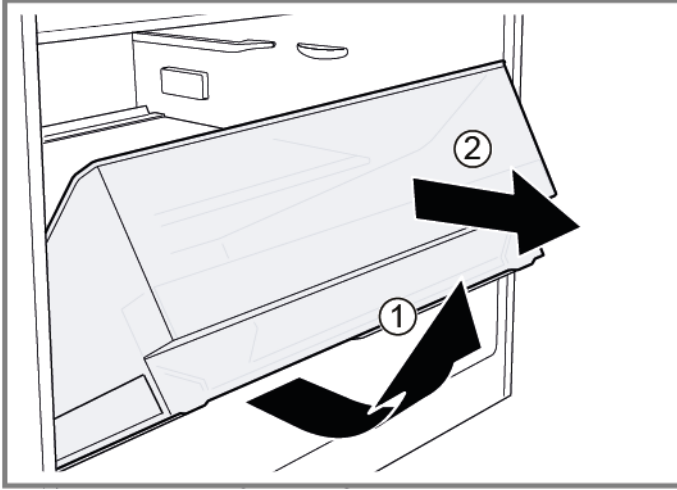

➡ Kapı çıkartılmıştır.

### 4.9.2 Meyve-sebze kabının takılması

- ▶ Ters sıra ile monte edin.

## 4.10 Meyve-sebze kabı bölmesinin ve kapağının değiştirilmesi

Ön koşul:

- ✓ Kapı açık.

### 4.10.1 Meyve-sebze kabı bölmesinin ve kapağının çıkartılması

1. Cam plakayı bölmeden çıkartın.

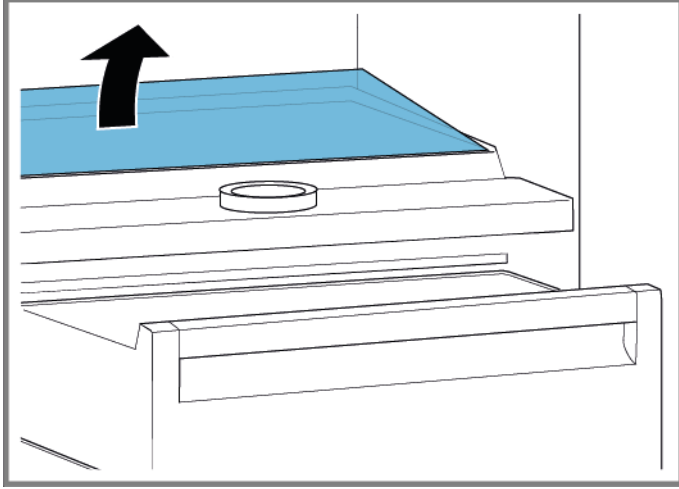

2. [Meyve-sebze kabını çıkartın.→572](#)

3. 1. Her iki bölme tarafında alt taraftaki kola bastırın (1).
2. Bölmeyi öne doğru çekin (2).

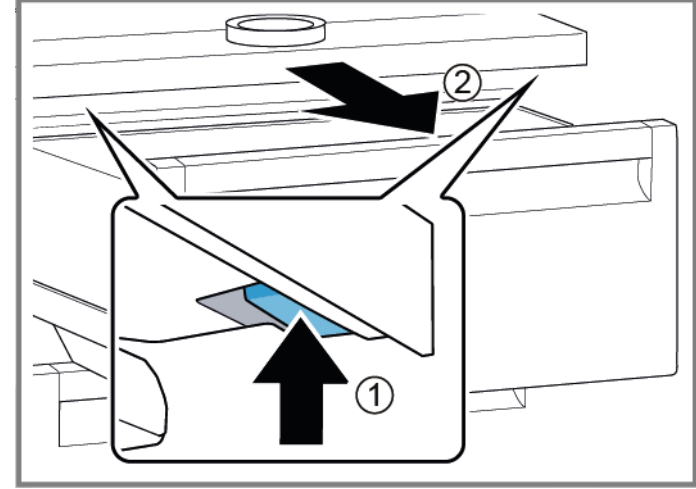

4. Bölmeyi kaldırın ve yana doğru döndürerek çıkartın.  
➡ Bölme çıkartılmıştır.
5. 1. Meyve-sebze kabının kapağını kaldırın.  
2. Meyve-sebze kabının kapağını öne doğru çekin ve yana doğru döndürerek çıkartın.  
➡ Meyve-sebze kabının kapağı çıkartılmıştır.

### 4.10.2 Meyve-sebze kabı bölmesinin ve kapağının takılması

- Ters sıra ile monte edin.

## 4.11 Soğutma-taze tutma kabının değiştirilmesi

Ön koşul:

- ✔ Kapı açık.

### 4.11.1 Soğutma-taze tutma kabının çıkartılması

- ▶ 1. Soğutma-taze tutma kabını öne doğru devirin (1).
- ▶ 2. Soğutma-taze tutma kabını çıkartın (2).

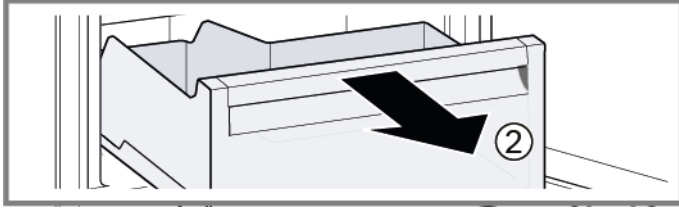
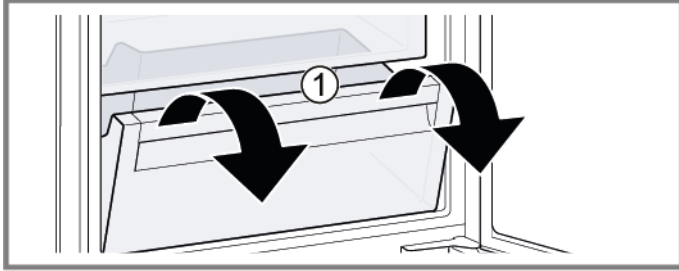

➡ Soğutma-taze tutma kabı çıkartılmıştır.

### 4.11.2 Soğutma-taze tutma kabının takılması

- ▶ Ters sıra ile monte edin.

## 4.12 Uzatılabilir kabın değiştirilmesi

Ön koşul:

- ✓ Kapı açık.

### 4.12.1 Uzatılabilir kabın çıkartılması

- ▶ 1. Uzatılabilir kabı öne doğru devirin (1).
- ▶ 2. Uzatılabilir kabı çıkartın (2).

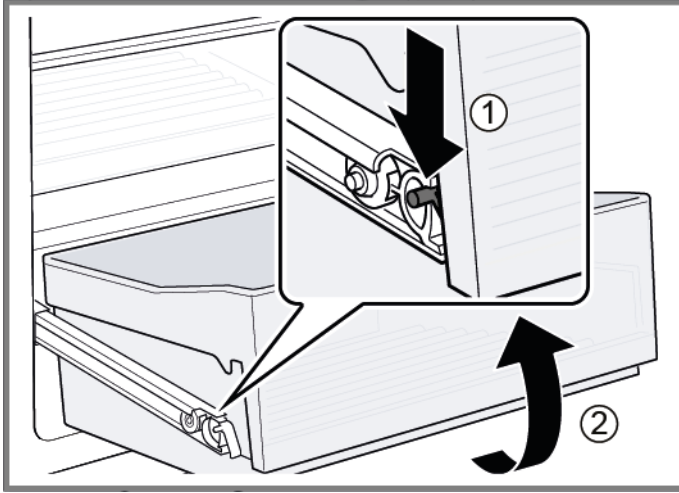

➡ Uzatılabilir kap çıkartılmıştır.

### 4.12.2 Uzatılabilir kabın takılması

- ▶ Ters sıra ile monte edin.

## 4.13 LED spot ışığının değiştirilmesi

Özel yardımcı ekipman:

- Special tool [00342180]
- Düz tornavida Bıçak 2,4 mm x 0,4 mm x 60 mm, [00341820] numaralı kit içinde

**i** Cihazınızda bakım gerektirmeyen bir LED ışık bulunmaktadır. Bu ışıklar sadece müşteri hizmetleri veya yetkili teknisyenler tarafından değiştirilebilir!

**! TEHLİKE**  
**Gerilim ileten parçalar nedeniyle elektrik çarpması tehlikesi!!**  
Onarımın düzgün yapılmaması nedeniyle elektrik çarpması sonucu hayati tehlike

- ▶ Elektrikli parçaların onarımı kalifiye bir elektrik uzmanı tarafından gerçekleştirilmelidir.
- ▶ Onarım sonrasında VDE 0701 veya ülkeye özel düzenlemeler uyarınca bir güvenlik testi gerçekleştirilmelidir.

**! TEHLİKE**  
**Gerilim ileten parçalar nedeniyle elektrik çarpması tehlikesi!!**  
Elektrik çarpması sebebiyle ölüm

- ▶ Onarıma başlamadan önce cihazın elektrik şebeke bağlantısını en az 60 saniye süreyle sökün.

**! DİKKAT**  
**Keskin köşeler!**  
Kesik yaralanmaları

- ▶ Koruyucu eldiven kullanılmalıdır.

Ön koşul:

- ✓ Cihazın fişi çekilir.
- ✓ Kapı açık.
- ✓ Soğutucu bölüm rafları çıkartılmıştır.

### 4.13.1 LED spot ışığının çıkartılması

- LED yan ışık kapağını çıkartın.

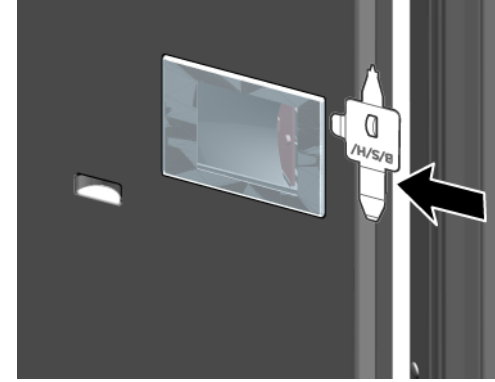

- LED spot ışığı kapağını içe doğru çekin ve aynı anda öne doğru itin.

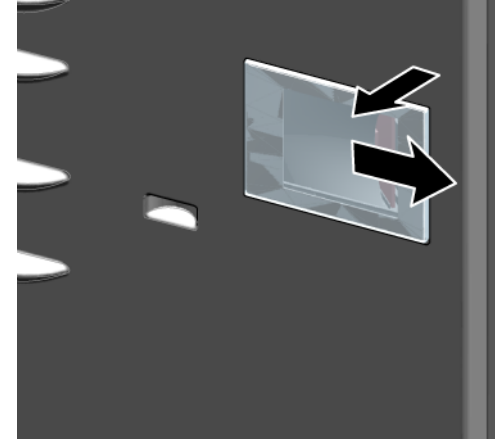



3. LED spot ışık modülünü ayırın.

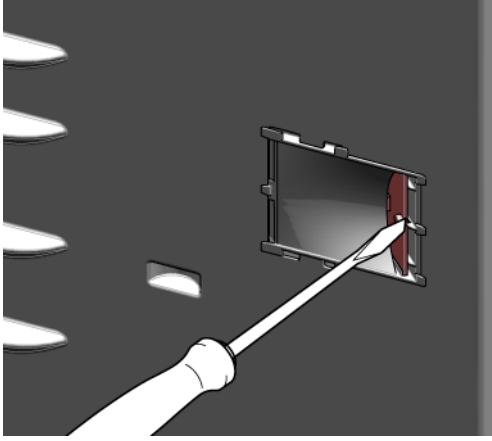

4. LED spot ışığının elektrik bağlantısını ayırın.

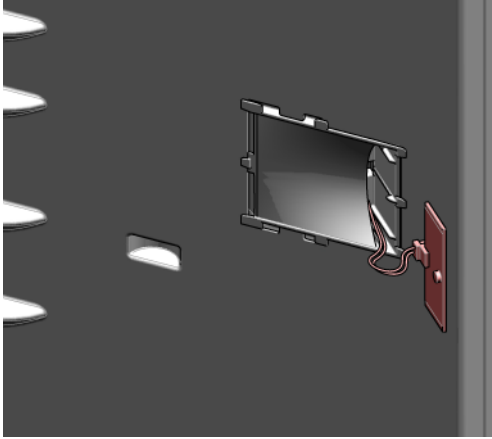

 LED spot ışığı çıkartılmıştır.

#### 4.13.2 LED spot ışığının takılması

▶ Ters sıra ile monte edin.